

VAR-18076077M6S-K



Series	VAR-18
Type	Side Electrode
Number of Electrode	6
Status	Production (Not Recommended for New Design)



Size	
Outer Diameter(ΦD1)	7.60mm ±0.20mm
Inner Diameter(ΦD2)	5.00mm ±0.20mm
Thickness(T)	0.60mm Max.

Electrical Characteristics	
Reference Current	10mA
Varistor Voltage	5.9 to 9.4V
Non Linear Coefficient [1 to 10mA]	2.3
Temperature Coefficient of Varistor Voltage	±0.3%/°C
Capacitance (Min.) [1kHz]	1nF
Capacitance (Max.) [1kHz]	50nF
Rated Power	300mW

Other	
Operating Temperature Range	-25 to 85°C
Packing	Bulk(Polystyrene form)
Package Quantity	5000pcs
Weight	0.066g

! Images are for reference only and show exemplary products.
! This PDF document was created based on the data listed on the TDK Corporation website.
! All specifications are subject to change without notice.



Associated Images

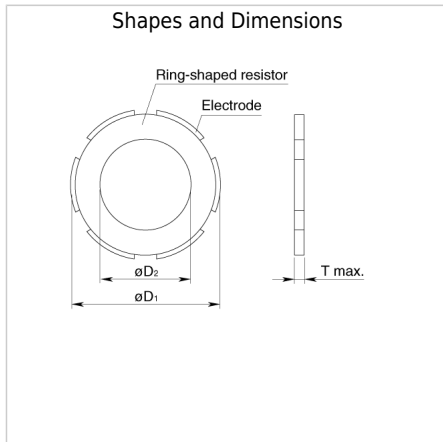

! Images are for reference only and show exemplary products.
! This PDF document was created based on the data listed on the TDK Corporation website.
! All specifications are subject to change without notice.