

**PACKAGE DIMENSIONS**

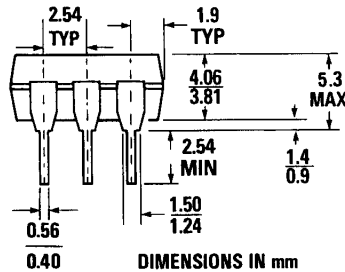

ST1603A

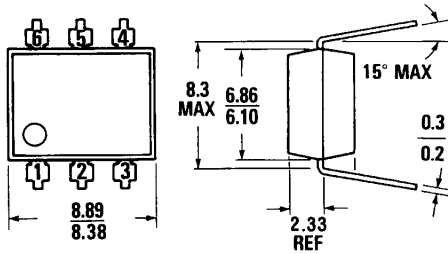
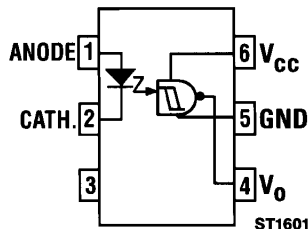

Equivalent Circuit

**DESCRIPTION**

The H11L series has a medium-to-high speed integrated circuit detector optically coupled to a gallium-arsenide infrared emitting diode. The output incorporates a Schmitt trigger, which provides hysteresis for noise immunity and pulse shaping. The detector circuit is optimized for simplicity of operation and utilizes an open collector output for maximum application flexibility.

**FEATURES**

- High data rate, 1 MHz typical (NRZ)
- Free from latch up and oscillation throughout voltage and temperature ranges.
- Microprocessor compatible drive
- Logic compatible output sinks 16 mA at 0.4 V maximum
- Guaranteed on/off threshold hysteresis
- High common mode rejection ratio
- Fast switching:  $t_r, t_f=100$  ns typical
- Wide supply voltage capability, compatible with all popular logic systems
- Underwriters Laboratory (UL) recognized — file #E90700

**APPLICATIONS**

- Logic to logic isolator
- Programmable current level sensor
- Line receiver—eliminate noise and transient problems
- A.C. to TTL conversion—square wave shaping
- Digital programming of power supplies
- Interfaces computers with peripherals

**ABSOLUTE MAXIMUM RATINGS**

**TOTAL PACKAGE**

Storage temperature . . . . .  $-55^{\circ}\text{C}$  to  $150^{\circ}\text{C}$   
 Operating temperature . . . . .  $-55^{\circ}\text{C}$  to  $100^{\circ}\text{C}$   
 Lead solder temperature . . . . .  $260^{\circ}\text{C}$  for 10 sec

**INPUT DIODE**

Power dissipation ( $25^{\circ}\text{C}$  ambient) . . . . . 100 mW  
 Derate linearly (above  $25^{\circ}\text{C}$  ambient) . . . . .  $1.33$  mW/ $^{\circ}\text{C}$   
 Continuous forward current . . . . . 60 mA  
 Peak forward current ( $1\ \mu\text{s}$  pulse, 300pps) . . . . . 3 A  
 Reverse voltage . . . . . 6 V

**DETECTOR**

Power dissipation (at  $25^{\circ}\text{C}$  ambient) . . . . . 150 mW  
 Derate linearly (above  $25^{\circ}\text{C}$  ambient) . . . . .  $2$  mW/ $^{\circ}\text{C}$   
 $V_{45}$  allowed range . . . . . 0 to 16 V  
 $V_{65}$  allowed range . . . . . 0 to 16 V  
 $I_o$  output current . . . . . 50 mA



## MICROPROCESSOR COMPATIBLE GaAs SCHMITT TRIGGER OPTOCOUPLERS

### ELECTRICAL CHARACTERISTICS ( $T_A = 0-70^\circ\text{C}$ Unless Otherwise Specified)

#### INDIVIDUAL COMPONENT CHARACTERISTICS

PARAMETER	SYMBOL	MIN.	TYP.	MAX.	UNITS	TEST CONDITIONS
<b>INPUT DIODE</b>						
Forward voltage	$V_F$		1.1	1.5	V	$I_f = 10 \text{ mA}$
	$V_F$	0.75	0.95		V	$I_f = 0.3 \text{ mA}$
Reverse current	$I_R$			10	$\mu\text{A}$	$V_R = 3 \text{ V}$
Capacitance	$C_J$			100	pF	$V = 0, f = 1 \text{ MHz}$
<b>OUTPUT DETECTOR</b>						
Operating voltage range	$V_{CC}$	3		15	V	
Supply current	$I_{c(off)}$		1.0	5.0	mA	$I_e = 0, V_{CC} = 5 \text{ V}$
Output current, high	$I_{OH}$			100	$\mu\text{A}$	$I_e = 0, V_{CC} = V_O = 15 \text{ V}$

#### TRANSFER CHARACTERISTICS

CHARACTERISTIC	SYMBOL	MIN.	TYP.	MAX.	UNITS	TEST CONDITIONS
Supply current	$I_{e(on)}$		1.6	5	mA	$I_f = 10 \text{ mA}, V_{CC} = 5 \text{ V}$
Output voltage, low	$V_{OL}$		0.2	0.4	V	$R_L = 270 \Omega, V_{CC} = 5 \text{ V}, I_e = I_{F(on)} \text{ max.}$
Turn-on threshold current	(H11L1) $I_{F(on)}$		1.0	1.6	mA	$R_L = 270 \Omega, V_{CC} = 5 \text{ V}$
	(H11L2) $I_{F(on)}$		6.0	10.0	mA	$R_L = 270 \Omega, V_{CC} = 5 \text{ V}$
	(H11L3) $I_{F(on)}$		3.0	5.0	mA	$R_L = 270 \Omega, V_{CC} = 5 \text{ V}$
Turn-off threshold current	$I_{F(off)}$	0.3	1.0		mA	$R_L = 270 \Omega, V_{CC} = 5 \text{ V}$
Hysteresis ratio	$I_{F(off)} / I_{F(on)}$	0.50	0.75	0.90		$R_L = 270 \Omega, V_{CC} = 5 \text{ V}$



## MICROPROCESSOR COMPATIBLE GaAs SCHMITT TRIGGER OPTOCOUPLERS

<b>DYNAMIC CHARACTERISTICS</b>						
PARAMETER	SYMBOL	MIN.	TYP.	MAX.	UNITS	TEST CONDITIONS
<b>SWITCHING SPEED</b>						
Turn-on time	$t_{ON}$		1.0		$\mu S$	$C=0, R_E=1.2 k\Omega$
	$t_{ON}$		0.65		$\mu S$	$C=270 pF, R_E=1.2 k\Omega$ $f \leq 100 KHz, t_p \geq 1 \mu s$
Fall time	$t_f$		0.1		$\mu S$	$C=0, R_E=1.2 k\Omega$
	$t_f$		0.05		$\mu S$	$C=270 pF, R_E=1.2 k\Omega$ $f \leq 100 KHz, t_p \geq 1 \mu s$
Turn-off time	$t_{OFF}$		2.0		$\mu S$	$C=0, R_E=1.2 k\Omega$
	$t_{OFF}$		1.20		$\mu S$	$C=270 pF, R_E=1.2 k\Omega$ $f \leq 100 KHz, t_p \geq 1 \mu s$
Rise time	$t_r$		0.1		$\mu S$	$C=0, R_E=1.2 k\Omega$
	$t_r$		0.07		$\mu S$	$C=270 pF, R_E=1.2 k\Omega$ $f \leq 100 KHz, t_p \geq 1 \mu s$
Data rate			1.0*		MHz	

<b>ISOLATION CHARACTERISTICS</b>						
CHARACTERISTIC	SYMBOL	MIN.	TYP.	MAX.	UNITS	TEST CONDITIONS
Surge isolation voltage	$V_{ISO}$	7500			$V_{PEAK}$	1 Minute
Surge isolation voltage	$V_{ISO}$	5300			$V_{RMS}$	1 Minute

\*Maximum data rate will vary depending on the bias conditions and is usually highest when  $R_E$  and  $C$  are matched to  $I_{F(ON)}$  and  $V_{CC}$  is between 3 and 15 V. With this optimized bias, most units will operate over 1.5 MHz (NRZ).

**SWITCHING CHARACTERISTICS (25°C) H11L1**

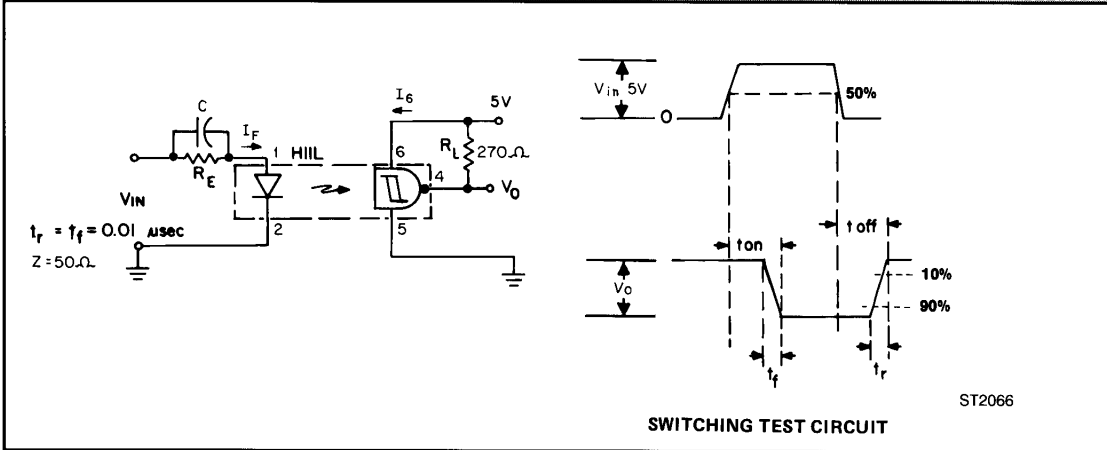

**TYPICAL CHARACTERISTICS**

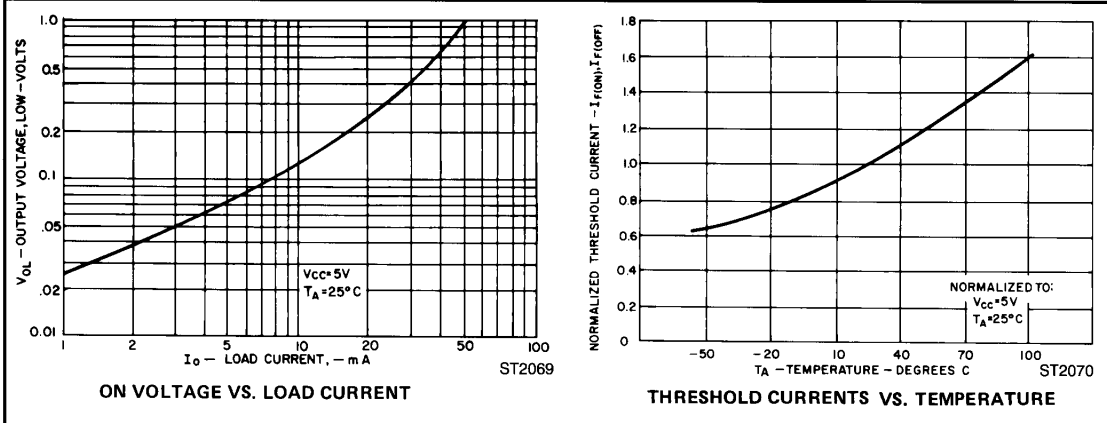
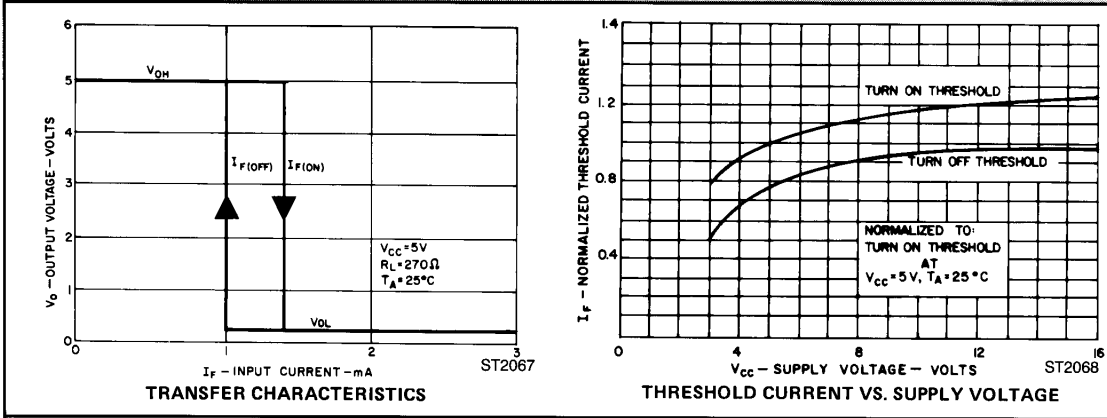

**TYPICAL CHARACTERISTICS (Cont'd)**

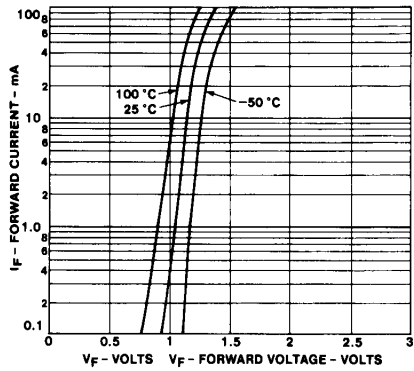

ST2015

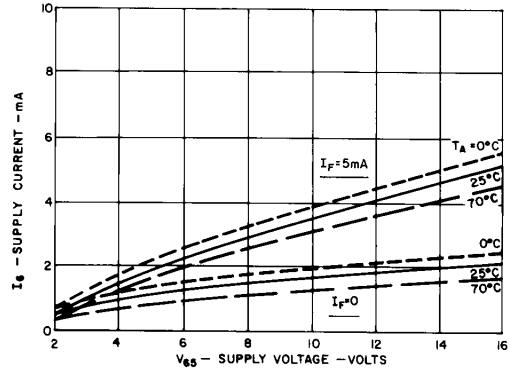

ST2016

**FORWARD VOLTAGE VS. FORWARD CURRENT**

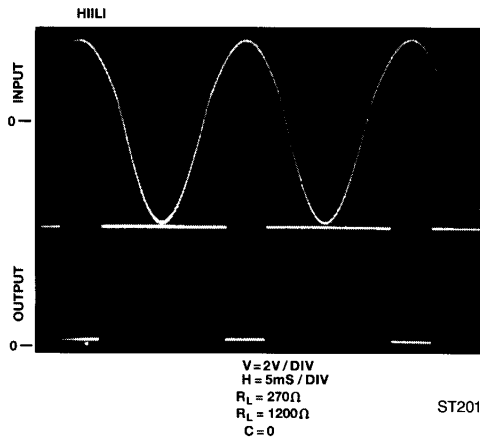

ST2017

**SUPPLY CURRENT VS. SUPPLY VOLTAGE**

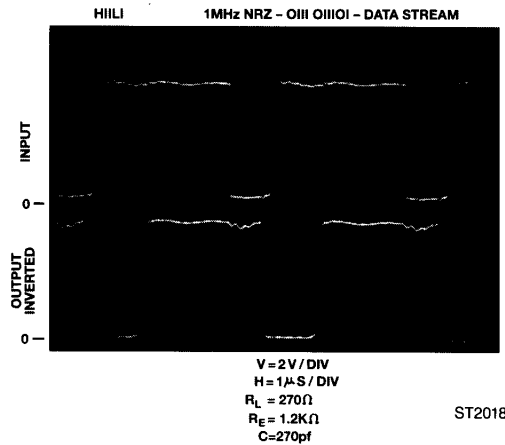

ST2018



## MICROPROCESSOR COMPATIBLE GaAs SCHMITT TRIGGER OPTOCOUPLERS

### TYPICAL APPLICATION

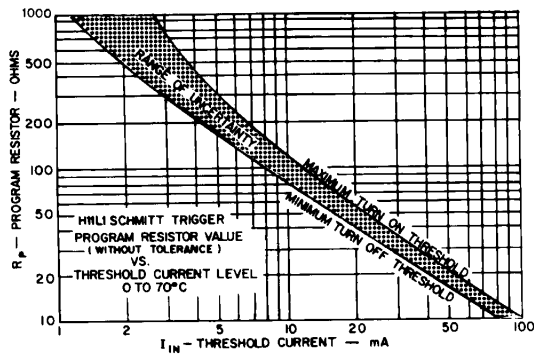

ST2019

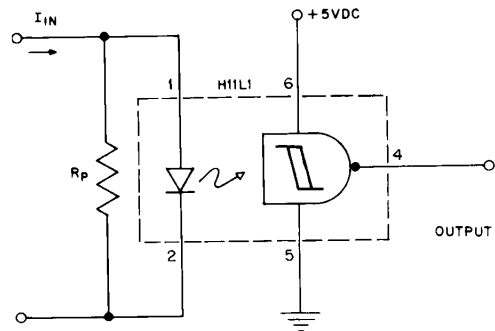

PROGRAMMABLE CURRENT THRESHOLD SENSING CIRCUIT