



High-Efficiency, Seamless Transition, Step-Up/Down DC-DC Converter

MAX8625A

General Description

The MAX8625A PWM step-up/down regulator is intended to power digital logic, hard disk drives, motors, and other loads in portable, battery-powered devices such as PDAs, cell phones, digital still cameras (DSCs), and MP3 players. The MAX8625A provides either a fixed 3.3V or adjustable output voltage (1.25V to 4V) at up to 0.8A from a 2.5V to 5.5V input. The MAX8625A utilizes a 2A peak current limit.

Maxim's proprietary H-bridge topology* provides a seamless transition through all operating modes without the glitches commonly seen with other devices. Four internal MOSFETs (two switches and two synchronous rectifiers) with internal compensation minimize external components. A SKIP input selects a low-noise, fixed-frequency PWM mode, or a high-efficiency skip mode where the converter automatically switches to PFM mode under light loads for best light-load efficiency. The internal oscillator operates at 1MHz to allow for a small external inductor and capacitors.

The MAX8625A features current-limit circuitry that shuts down the IC in the event of an output overload. In addition, soft-start circuitry reduces inrush current during startup. The IC also features True Shutdown™, which disconnects the output from the input when the IC is disabled. The MAX8625A is available in a 3mm x 3mm, 14-pin TDFN package.

Applications

PDAs and Smartphones
DSCs and Camcorders
MP3 Players and Cellular Phones
Battery-Powered Hard Disk Drive (HDD)

Pin Configuration

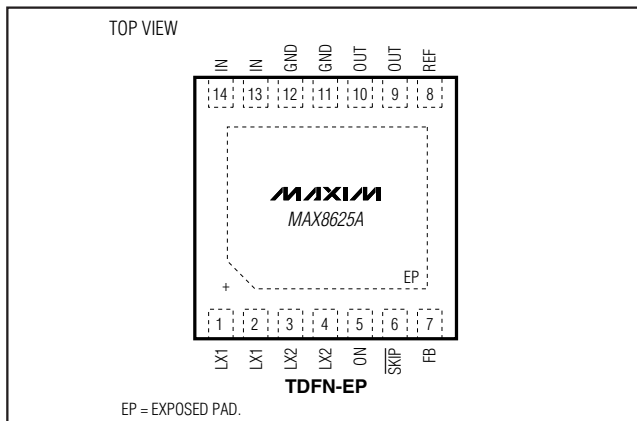

*US Patent #7,289,119.

True Shutdown is a trademark of Maxim Integrated Products, Inc.



Features

- ◆ Four Internal MOSFET True H-Bridge Buck/Boost
- ◆ Glitch-Free, Buck-Boost Transitions
- ◆ Minimal Output Ripple Variation on Transitions
- ◆ Up to 92% Efficiency
- ◆ 37µA (typ) Quiescent Current in Skip Mode
- ◆ 2.5V to 5.5V Input Range
- ◆ Fixed 3.3V or Adjustable Output
- ◆ 1µA (max) Logic-Controlled Shutdown
- ◆ True Shutdown
- ◆ Output Overload Protection
- ◆ Internal Compensation
- ◆ Internal Soft-Start
- ◆ 1MHz Switching Frequency
- ◆ Thermal-Overload Protection
- ◆ Small 3mm x 3mm, 14-Pin TDFN Package

Ordering Information

PART	PIN-PACKAGE	TOP MARK	PKG CODE
MAX8625AETD+	14 TDFN-EP** (3mm x 3mm)	ABQ	T1433-2

Note: The device is specified over the -40°C to +85°C extended temperature range.

+Denotes a lead-free package.

**EP = Exposed pad.

Typical Operating Circuit

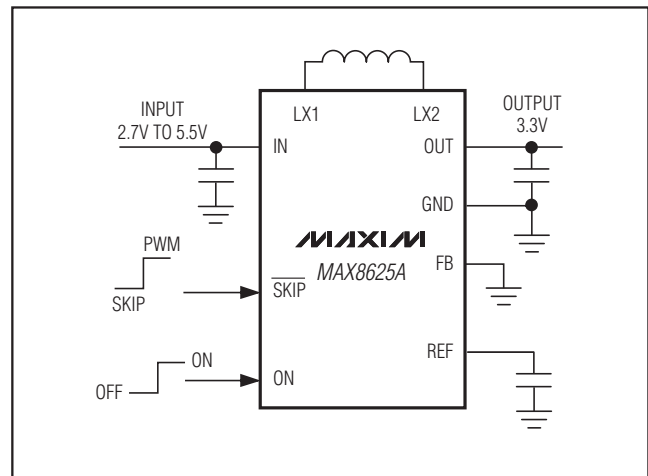

High-Efficiency, Seamless Transition, Step-Up/Down DC-DC Converter

ABSOLUTE MAXIMUM RATINGS

IN, OUT, $\overline{\text{SKIP}}$, ON to GND	-0.3V to +6V	Operating Temperature Range	-40°C to +85°C
REF, FB, to GND.....	-0.3V, (IN + 0.3V)	Junction Temperature	+150°C
LX2, LX1 (Note 1).....	$\pm 1.5A_{RMS}$	Storage Temperature Range	-65°C to +150°C
Continuous Power Dissipation ($T_A = +70^\circ\text{C}$)		Lead Temperature (soldering, 10s)	+300°C
Single-Layer Board (derate 18.5mW/°C			
above $T_A = +70^\circ\text{C}$)	1482mW		

Note 1: LX1 and LX2 have internal clamp diodes to IN, PGND and OUT, PGND, respectively. Applications that forward bias these diodes should take care not to exceed the device's power-dissipation limits.

Stresses beyond those listed under "Absolute Maximum Ratings" may cause permanent damage to the device. These are stress ratings only, and functional operation of the device at these or any other conditions beyond those indicated in the operational sections of the specifications is not implied. Exposure to absolute maximum rating conditions for extended periods may affect device reliability.

ELECTRICAL CHARACTERISTICS

($V_{IN} = 3.6\text{V}$, ON = $\overline{\text{SKIP}} = \text{IN}$, FB = GND, $V_{OUT} = 3.3\text{V}$, LX_ unconnected, $C_{REF} = C5 = 0.1\mu\text{F}$ to GND, Figure 4. $T_A = -40^\circ\text{C}$ to $+85^\circ\text{C}$. Typical values are at $T_A = +25^\circ\text{C}$, unless otherwise noted.) (Note 2)

PARAMETER	SYMBOL	CONDITIONS	MIN	TYP	MAX	UNITS
Supply Range	V_{IN}		2.5		5.5	V
UVLO Threshold	UVLO	V_{IN} rising, 60mV hysteresis	2.20		2.49	V
Quiescent Supply Current, FPWM Mode, Switching	I_{IN}	No load, $V_{OUT} = 3.2\text{V}$		15	22	mA
Quiescent Supply Current, Skip Mode, Switching	I_{IN}	$\overline{\text{SKIP}} = \text{GND}$, no load		37		μA
Quiescent Supply Current, No Switching, Skip Mode	I_{IN}	$\overline{\text{SKIP}} = \text{GND}$, FB = 1.3V		35	45	μA
Shutdown Supply Current	I_{IN}	ON = GND, $T_A = +25^\circ\text{C}$		0.1	1	μA
		$T_A = +85^\circ\text{C}$		0.2		
Output Voltage Accuracy (Fixed Output)		PWM mode, $V_{IN} = 2.5\text{V}$ to 5.5V		3.30		V
		$I_{OUT} = 0$ to 0.5A , $V_{IN} = 2.5\text{V}$ to 5.5V , $T_A = -40^\circ\text{C}$ to $+85^\circ\text{C}$ (Note 3)	-1		+1	%
		SKIP mode, valley regulation value		3.28		V
		Average skip voltage		3.285		
		Load step +0.5A		-3		%
Output Voltage Range (Adjustable Output)			1.25		4.00	V
Maximum Output Current		$V_{IN} = 3.6\text{V}$		0.80		A
Soft-Start		$L = 3.3\mu\text{H}$; $C_{OUT} = C3 + C4 = 44\mu\text{F}$		250		mA/ms
Load Regulation		$I_{OUT} = 0$ to 500mA		0.1		%/mA
Line Regulation		$V_{IN} = 2.5\text{V}$ to 5.5V		0.03		%/V
OUT Bias Current	I_{OUT}	$V_{OUT} = 3.3\text{V}$		3		μA
REF Output Voltage	V_{REF}	$V_{IN} = 2.5\text{V}$ to 5.5V	1.244	1.25	1.256	V
REF Load Regulation		$I_{REF} = 10\mu\text{A}$		1		mV
FB Feedback Threshold	V_{FB}	$I_{OUT} = 0$ to full load, PWM mode; $V_{IN} = 2.5\text{V}$ to 5.5V	1.244	1.25	1.258	V

High-Efficiency, Seamless Transition, Step-Up/Down DC-DC Converter

MAX8625A

ELECTRICAL CHARACTERISTICS (continued)

($V_{IN} = 3.6V$, $ON = \overline{SKIP} = IN$, $FB = GND$, $V_{OUT} = 3.3V$, LX_{-} unconnected, $C_{REF} = C5 = 0.1\mu F$ to GND, Figure 4. $T_A = -40^{\circ}C$ to $+85^{\circ}C$. Typical values are at $T_A = +25^{\circ}C$, unless otherwise noted.) (Note 2)

PARAMETER	SYMBOL	CONDITIONS	MIN	TYP	MAX	UNITS
FB Dual-Mode Threshold	V_{FBDM}		75	100	125	mV
FB Leakage Current	I_{FB}	$V_{FB} = 1.3V$, $T_A = +25^{\circ}C$		0.001	0.1	μA
		$V_{FB} = 1.3V$, $T_A = +85^{\circ}C$		0.01		
ON, \overline{SKIP} Input High Voltage	V_{IH}	$2.5V < V_{IN} < 5.5V$	1.6			V
ON, \overline{SKIP} Input Low Voltage	V_{IL}	$2.5V < V_{IN} < 5.5V$			0.45	V
ON Input Leakage Current	I_{IHL}	$2.5V < V_{IN} < 5.5V$, $T_A = +25^{\circ}C$		0.001	1	μA
		$T_A = +85^{\circ}C$		0.01		
\overline{SKIP} Input Leakage Current	I_{SKIPH}	$V_{\overline{SKIP}} = 3.6V$		3	12	μA
	$I_{SK IPL}$	$V_{\overline{SKIP}} = 0V$	-2	-0.2		
Peak Current Limit	I_{LIMP}	LX1 PMOS	1700	2000	2300	mA
Fault Latch-Off Delay				100		ms
MOSFET On-Resistance	R_{ON}	Each MOSFET, $T_A = +25^{\circ}C$		0.05	0.1	Ω
		Each MOSFET, $V_{IN} = 2.5V$ to $5.5V$, $T_A = -40^{\circ}C$ to $+85^{\circ}C$			0.2	
Rectifier-Off Current Threshold	I_{LX1OFF}	$\overline{SKIP} = GND$		125		mA
Idle-Mode Current Threshold (Note 4)	I_{SKIP}	$\overline{SKIP} = GND$, load decreasing		100		mA
		Load increasing		300		
LX1, LX2 Leakage Current	I_{LXLKG}	$V_{IN} = V_{OUT} = 5.5V$, $V_{LX1} = 0V$ to V_{IN} , $V_{LX2} = 0V$ to V_{OUT} , $T_A = +25^{\circ}C$		0.01	1	μA
		$T_A = +85^{\circ}C$		0.2		
Out Reverse Current	I_{LXLKGR}	$V_{IN} = V_{LX1} = V_{LX2} = 0V$, $V_{OUT} = 5.5V$, measure I (LX2), $T_A = +25^{\circ}C$		0.01	1	μA
		$T_A = +85^{\circ}C$		0.5		
Minimum T_{ON}	T_{ONMIN}			25		%
OSC Frequency	F_{OSCPWM}		850	1000	1150	kHz
Thermal Shutdown		15 $^{\circ}C$ hysteresis		+165		$^{\circ}C$

Note 2: Devices are production tested at $T_A = +25^{\circ}C$. Specifications over the operating temperature range are guaranteed by design and characterization.

Note 3: Limits are guaranteed by design and not production tested.

Note 4: The idle-mode current threshold is the transition point between fixed-frequency PWM operation and idle-mode operation. The specification is given in terms of output load current for an inductor value of $3.3\mu H$. For the step-up mode, the idle-mode transition varies with input to the output-voltage ratios.

High-Efficiency, Seamless Transition, Step-Up/Down DC-DC Converter

Typical Operating Characteristics

($V_{IN} = 3.6V$, $\overline{SKIP} = GND$, $T_A = +25^\circ C$, Figure 4, unless otherwise noted.)

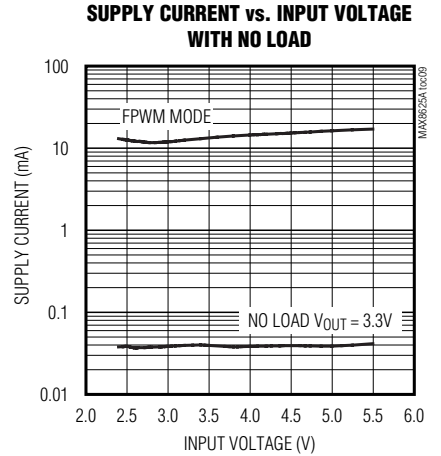
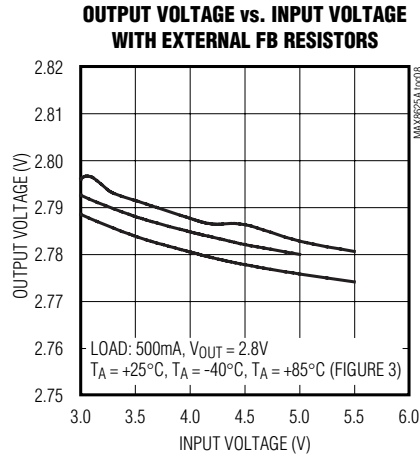
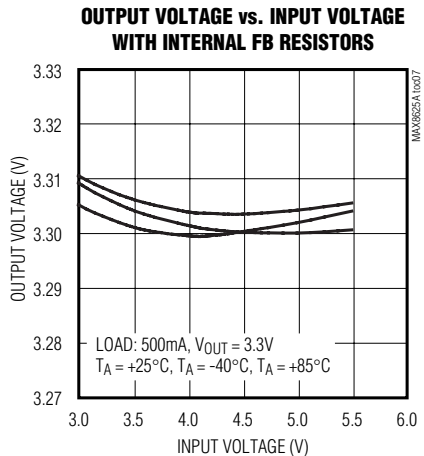
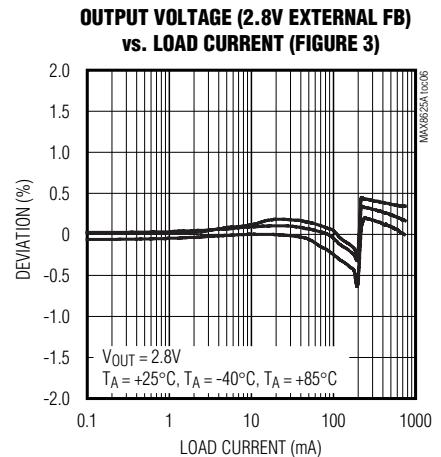
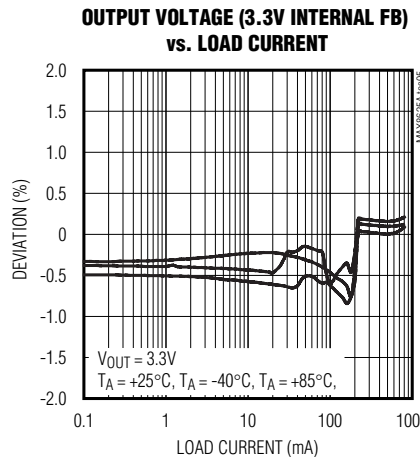
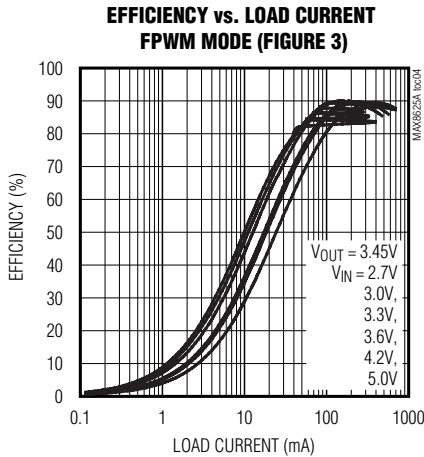
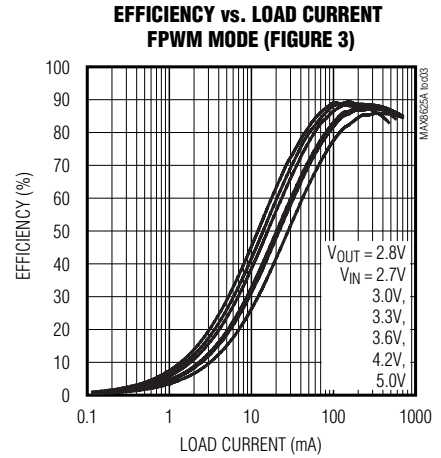
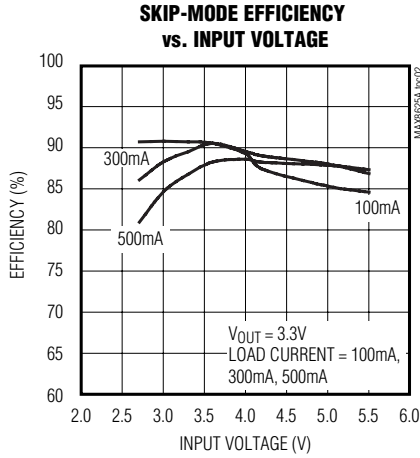
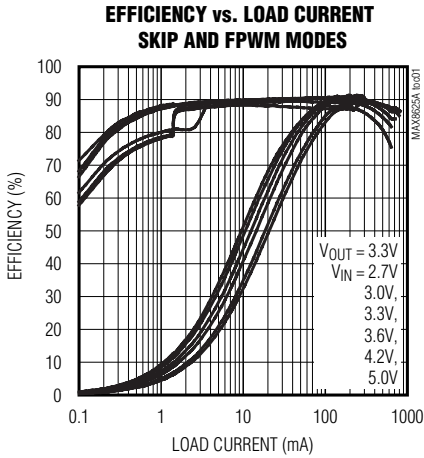

High-Efficiency, Seamless Transition, Step-Up/Down DC-DC Converter

MAX8625A

Typical Operating Characteristics (continued)

($V_{IN} = 3.6V$, $\overline{SKIP} = GND$, $T_A = +25^\circ C$, Figure 4, unless otherwise noted.)

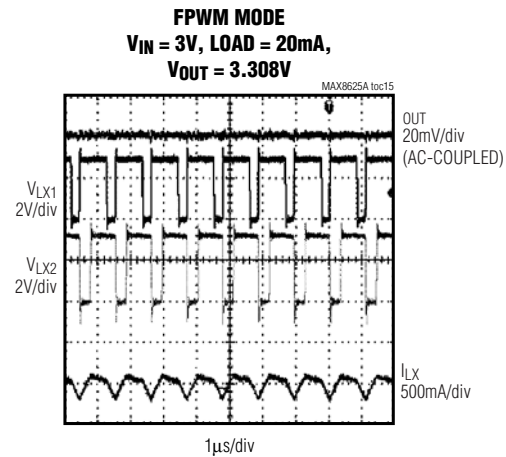
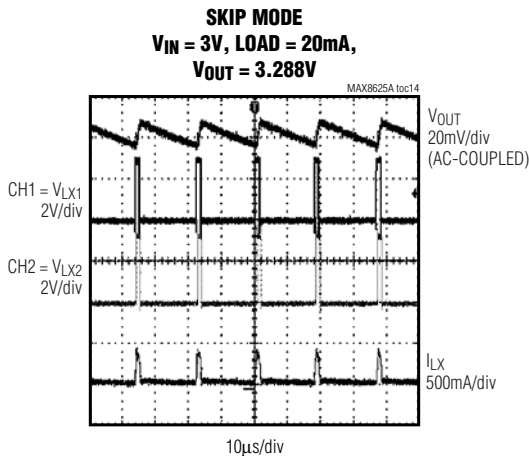
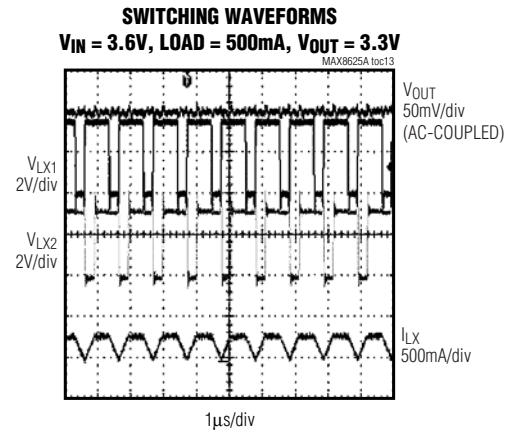
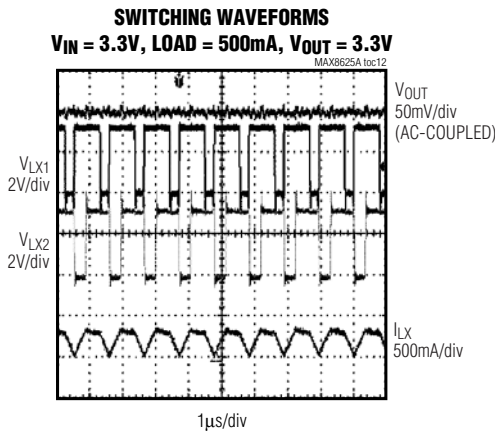
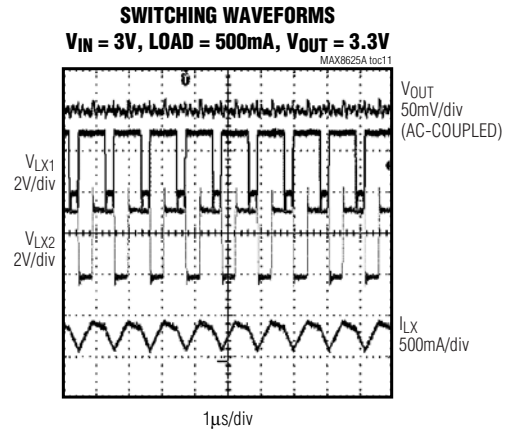
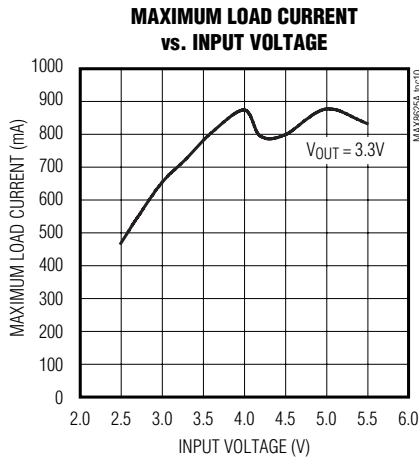

High-Efficiency, Seamless Transition, Step-Up/Down DC-DC Converter

Typical Operating Characteristics (continued)

($V_{IN} = 3.6V$, $\overline{SKIP} = GND$, $T_A = +25^\circ C$, Figure 4, unless otherwise noted.)

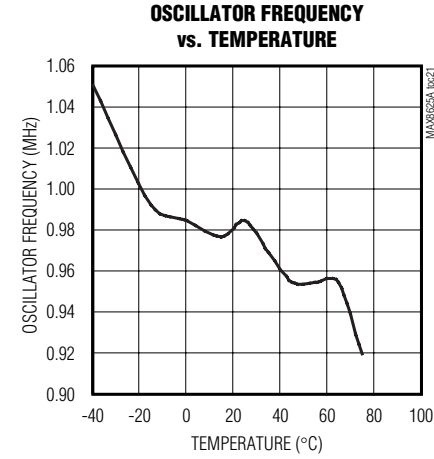
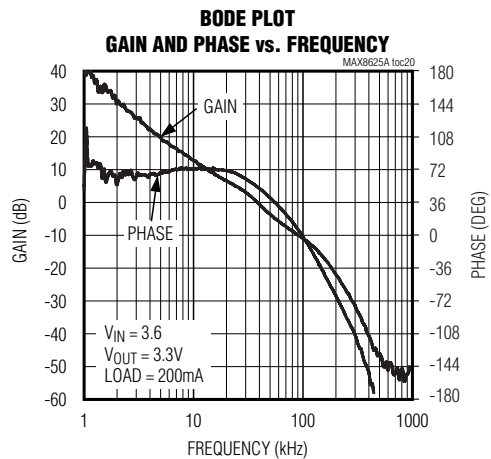
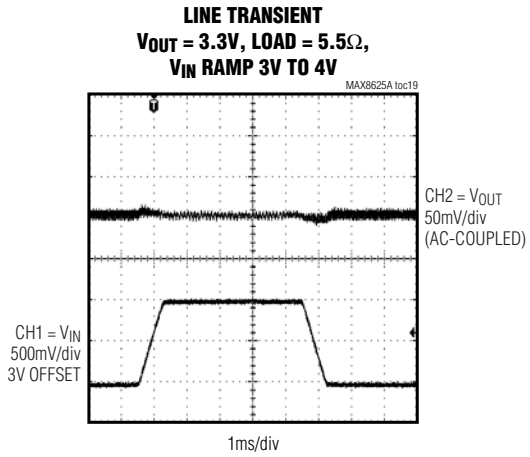
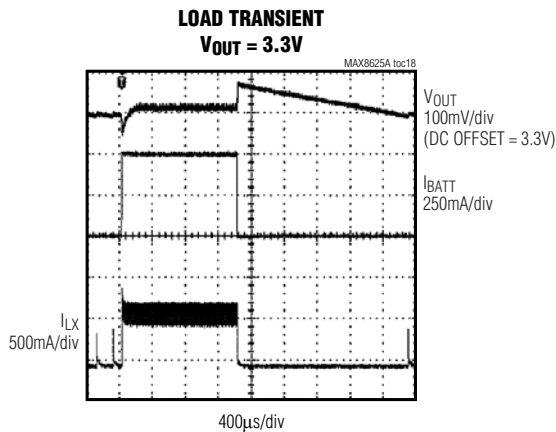
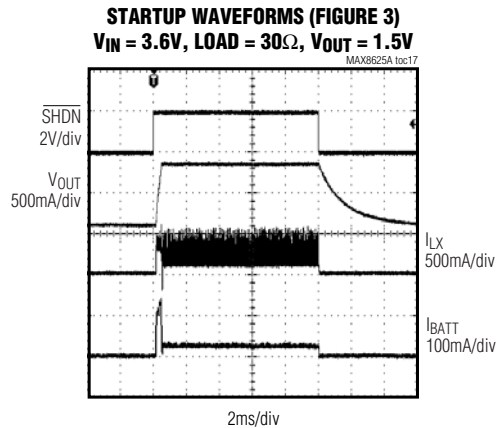
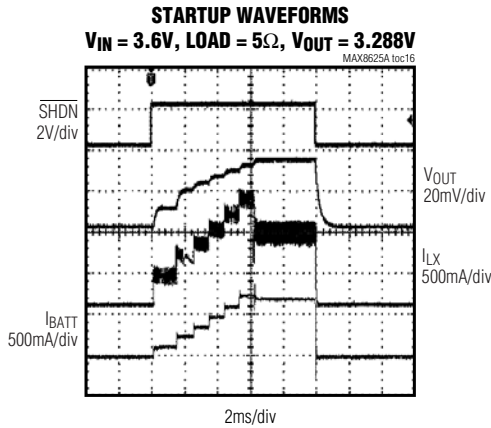

High-Efficiency, Seamless Transition, Step-Up/Down DC-DC Converter

MAX8625A

Typical Operating Characteristics (continued)

($V_{IN} = 3.6V$, $\overline{SKIP} = GND$, $T_A = +25^\circ C$, Figure 4, unless otherwise noted.)

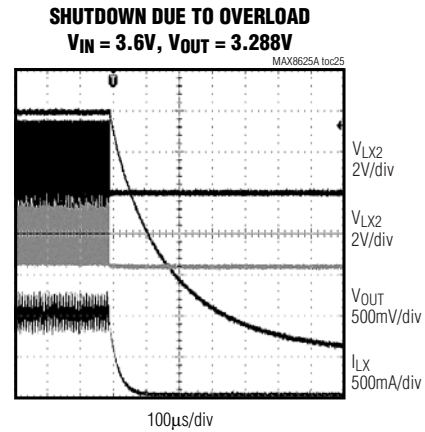
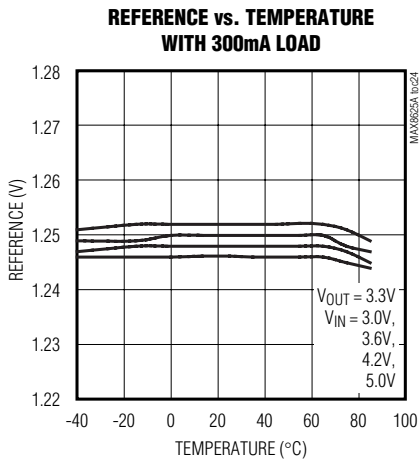
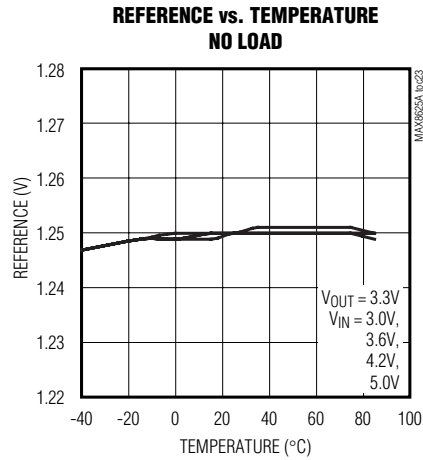
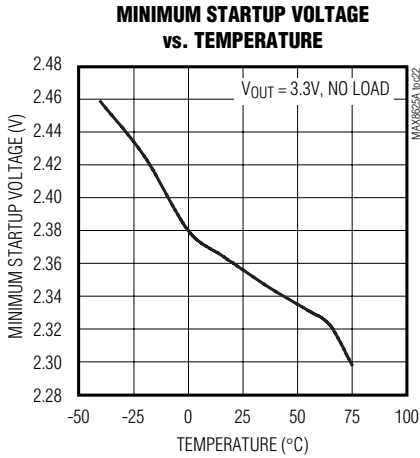

BOOST-TO-BUCK TRANSITION
FPWM MODE $V_{IN} = 3.6V$, $V_{OUT} = 3.288V$

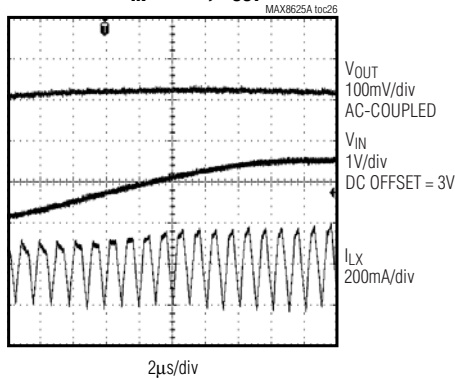

High-Efficiency, Seamless Transition, Step-Up/Down DC-DC Converter

Pin Description

PIN	NAME	FUNCTION
1, 2	LX1	Inductor Connection 1. Connect the inductor between LX1 and LX2. Both LX1 pins must be connected together externally. LX1 is internally connected to GND during shutdown.
3, 4	LX2	Inductor Connection 2. Connect the inductor between LX1 and LX2. Both LX2 pins must be connected together externally. LX2 is internally connected to GND during shutdown.
5	ON	Enable Input. Connect ON to the input or drive high to enable the IC. Drive ON low to disable the IC.
6	SKIP	Mode Select Input. Connect $\overline{\text{SKIP}}$ to GND to enable skip mode. This mode provides the best overall efficiency curve. Connect SKIP to IN to enable forced-PWM mode. This mode provides the lowest noise, but reduces light-load efficiency compared to skip mode.
7	FB	Feedback Input. Connect to ground to set the fixed 3.3V output. Connect FB to the center tap of an external resistor-divider from the output to GND to set the output voltage to a different value. V_{FB} regulates to 1.25V.
8	REF	Reference Output. Bypass REF to GND with a 0.1 μF ceramic capacitor. V_{REF} is 1.25V and is internally pulled to GND during shutdown.
9, 10	OUT	Power Output. Bypass OUT to GND with two 22 μF ceramic capacitors. Both OUT pins must be connected together externally.
11, 12	GND	Ground. Connect the exposed pad and GND directly under the IC.
13, 14	IN	Power-Supply Input. Bypass IN to GND with two 22 μF ceramic capacitors. Connect IN to a 2.5V to 5.5V supply. Both IN pins must be connected together externally.
—	EP	Exposed Pad. Connect to GND directly under the IC. Connect to a large ground plane for increased thermal performance.

Detailed Description

The MAX8625A step-up/down architecture employs a true H-bridge topology that combines a boost converter and a buck converter topology using a single inductor and output capacitor (Figure 1). The MAX8625A utilizes a pulse-width modulated (PWM), current-mode control scheme and operates at a 1MHz fixed frequency to minimize external component size. A proprietary H-bridge design eliminates mode changes when transitioning from buck to boost operation. This control scheme provides very low output ripple using a much smaller inductor than a conventional H-bridge, while avoiding glitches that are commonly seen during mode transitions with competing devices.

The MAX8625A switches at an internally set frequency of 1MHz, allowing for tiny external components. Internal compensation further reduces the external component count in cost- and space-sensitive applications. The MAX8625A is optimized for use in HDDs, DSCs, and other devices requiring low-quiescent current for optimal light-load efficiency and maximum battery life.

Control Scheme

The MAX8625A basic noninverting step-up/down converter operates with four internal switches. The control logic determines which two internal MOSFETs operate to maintain the regulated output voltage. Unlike a traditional H-bridge, the MAX8625A utilizes smaller peak-inductor currents, thus improving efficiency and lowering input/output ripple.

The MAX8625A uses three operating phases during each switching cycle. In phase 1 (fast-charge), the inductor current ramps up with a di/dt of V_{IN}/L . In phase 2 (slow charge/discharge), the current either ramps up or down depending on the difference between the input voltage and the output voltage $(V_{\text{IN}} - V_{\text{OUT}})/L$. In phase 3 (discharge), the inductor current discharges at a rate of V_{OUT}/L through MOSFETs P2 and N1 (see Figure 1). An additional fourth phase (phase 4: hold) is entered when the inductor current falls to zero during phase 3. This fourth phase is only used during skip operation.

The state machine (Figure 2) decides which phase to use and when to switch phases. The converter goes through the first three phases in the same order at all

High-Efficiency, Seamless Transition, Step-Up/Down DC-DC Converter

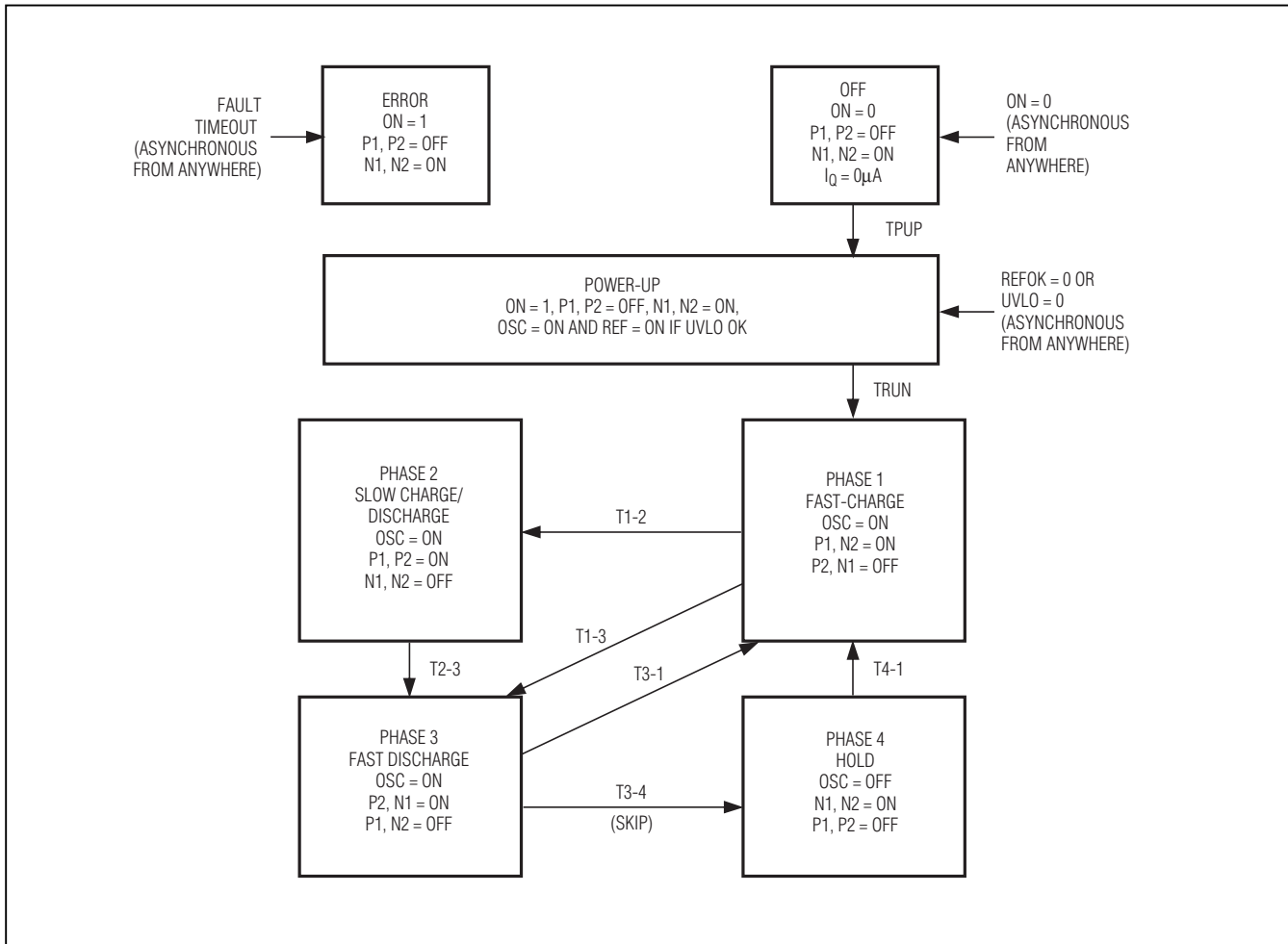

Figure 2. State Diagram

shuttling current in and out of the output capacitor. If $\overline{\text{SKIP}}$ is asserted high for forced-PWM mode, phase 4 is not entered and current shuttling is allowed (and is necessary to maintain the PWM operation frequency when no load is present).

Step-Up Operation ($V_{IN} < V_{OUT}$)

During medium and heavy loads when $V_{IN} < V_{OUT}$, MOSFETs P1 and N2 turn on at the clock edge to ramp up the inductor current. Phase 1 terminates when the inductor current reaches the peak target current set by the PWM comparator and N2 turns off. This is followed by a slow-discharge phase (phase 2) instead of a charge phase (since V_{IN} is less than V_{OUT}) when P2 turns on. The slow-discharge phase terminates on a clock edge. The converter now enters the fast-discharge phase (phase 3). During phase 3, P1 turns off

and N1 turns on. At the end of the minimum time, both P2 and N1 turn off and the cycle repeats.

If $\overline{\text{SKIP}}$ is asserted low, during light loads when inductor current falls to zero in phase 3, the converter switches to phase 4 (hold) to reduce power consumption and avoid shuttling current in and out of the output. If $\overline{\text{SKIP}}$ is high to assert forced-PWM mode, the converter never enters phase 4 and allows negative inductor current.

Step-Up/Down Transition-Zone Operation ($V_{IN} = V_{OUT}$)

When $V_{IN} = V_{OUT}$, the converter still goes through the three phases for moderate to heavy loads. However, the maximum time is now spent in phase 2 where inductor current di/dt is almost zero, since it is proportional to $(V_{IN} - V_{OUT})$. This eliminates transition glitches

High-Efficiency, Seamless Transition, Step-Up/Down DC-DC Converter

or oscillation between the boost and buck modes as seen in other step-up/down converters. See the switching waveforms for each of the three modes and transition waveforms in the *Typical Operating Characteristics* section.

Forced-PWM Mode

Drive $\overline{\text{SKIP}}$ high to operate the MAX8625A in forced-PWM mode. In this mode, the IC operates at a constant 1MHz switching frequency with no pulse skipping. This scheme is desirable in noise-sensitive applications because the output ripple is minimized and has a predictable noise spectrum. Forced PWM consumes higher supply current at light loads due to constant switching.

Skip Mode

Drive $\overline{\text{SKIP}}$ low to operate the MAX8625A in skip mode to improve light-load efficiency. In skip mode, the IC switches only as necessary to maintain the output at light loads, but still operates with fixed-frequency PWM at medium and heavy loads. This maximizes light-load efficiency and reduces the input quiescent current to 37 μA (typ).

Load Regulation and Transient Response

During a load transient, the output voltage instantly changes due to the ESR of the output capacitors by an amount equal to their ESR times the change in load current ($\Delta V_{\text{OUT}} = \text{RESR} \times \Delta I_{\text{LOAD}}$). The output voltage then deviates further based on the speed at which the loop compensates for the load step. Increasing the output capacitance reduces the output-voltage droop. See the *Capacitor Selection* section. The typical application circuit limits the output transient droop to less than 3%. See the *Typical Operating Characteristics* section.

Soft-Start

Soft-start prevents input inrush current during startup. Internal soft-start circuitry ramps the peak inductor current with an internal DAC in 8ms. Once the output reaches regulation, the current limit immediately jumps to the maximum threshold. This allows full load capability as soon as regulation is reached, even if it occurs before the 8ms soft-start time is complete.

Shutdown

Drive ON low to place the MAX8625A in shutdown mode and reduce supply current to less than 1 μA . During shutdown, OUT is disconnected from IN, and LX1 and LX2 are connected to GND. Drive ON high for normal operation.

Fault and Thermal Shutdown

The MAX8625A contains current-limit and thermal shutdown circuitry to protect the IC from fault conditions. When the inductor current exceeds the current limit (2A for the MAX8625A), the converter immediately enters phase 3 and an internal 100ms timer starts. The converter continues to commutate through the three phases, spending most of its time in phase 1 and phase 3. If the overcurrent event continues and the output is out of regulation for the duration of the 100ms timer, the IC enters shutdown mode and the output latches off. ON must then be toggled to clear the fault. If the overload is removed before the 100ms timer expires, the timer is cleared and the converter resumes normal operation.

The thermal-shutdown circuitry disables the IC switching if the die temperature exceeds +165°C. The IC begins soft-start once the die temperature cools by 15°C.

High-Efficiency, Seamless Transition, Step-Up/Down DC-DC Converter

Applications Information

Selecting the Output Voltage

The MAX8625A output is nominally fixed at 3.3V. Connect FB to GND to select the internally fixed-output voltage. For an adjustable output voltage, connect FB to the center tap of an external resistor-divider connected from the output to GND (R1 and R2 in Figure 3). Select 100k Ω for R2 and calculate R1 using the following equation:

$$R1 = 100k\Omega \times \left(\frac{V_{OUT}}{V_{FB}} - 1 \right)$$

where $V_{FB} = 1.25V$ and V_{OUT} is the desired output regulation voltage. V_{OUT} must be between 1.25V and 4V. Note that the minimum output voltage is limited by the minimum duty cycle. V_{OUT} cannot be below 1.25V.

Calculating Maximum Output Current

The maximum output current provided by the MAX8625A circuit depends on the inductor value, switching frequency, efficiency, and input/output voltage.

See the *Typical Operating Characteristics* section for the Maximum Load Current vs. Input Voltage graph.

Capacitor Selection

The input and output ripple currents are both discontinuous in this topology. Therefore, select at least two 22 μF ceramic capacitors at the input. Select two 22 μF ceramic output capacitors. For best stability over a wide temperature range, use X5R or better dielectric.

Inductor Selection

The recommended inductance range for the MAX8625A is 3.3 μH to 4.7 μH . Larger values of L give a smaller ripple, while smaller L values provide a better transient response. This is because, for boost and step-up/down topologies, the crossover frequency is inversely proportional to the value of L for a given load and input voltage. The MAX8625A is internally compensated, and therefore, the choice of power components for stable operation is bounded. A 3.3 μH inductor with 2A rating is recommended for the 3.3V fixed output with 0.8A load.

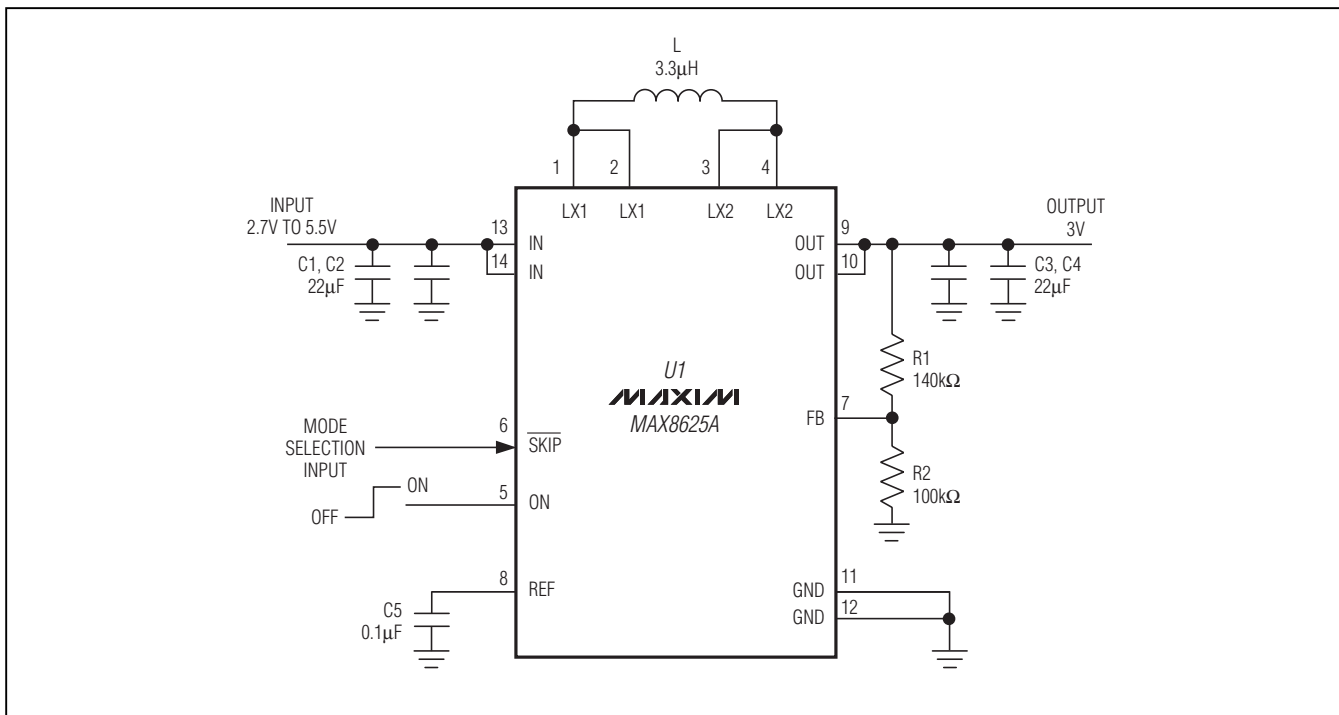

Figure 3. Typical Application Circuit (Adjustable Output)

High-Efficiency, Seamless Transition, Step-Up/Down DC-DC Converter

MAX8625A

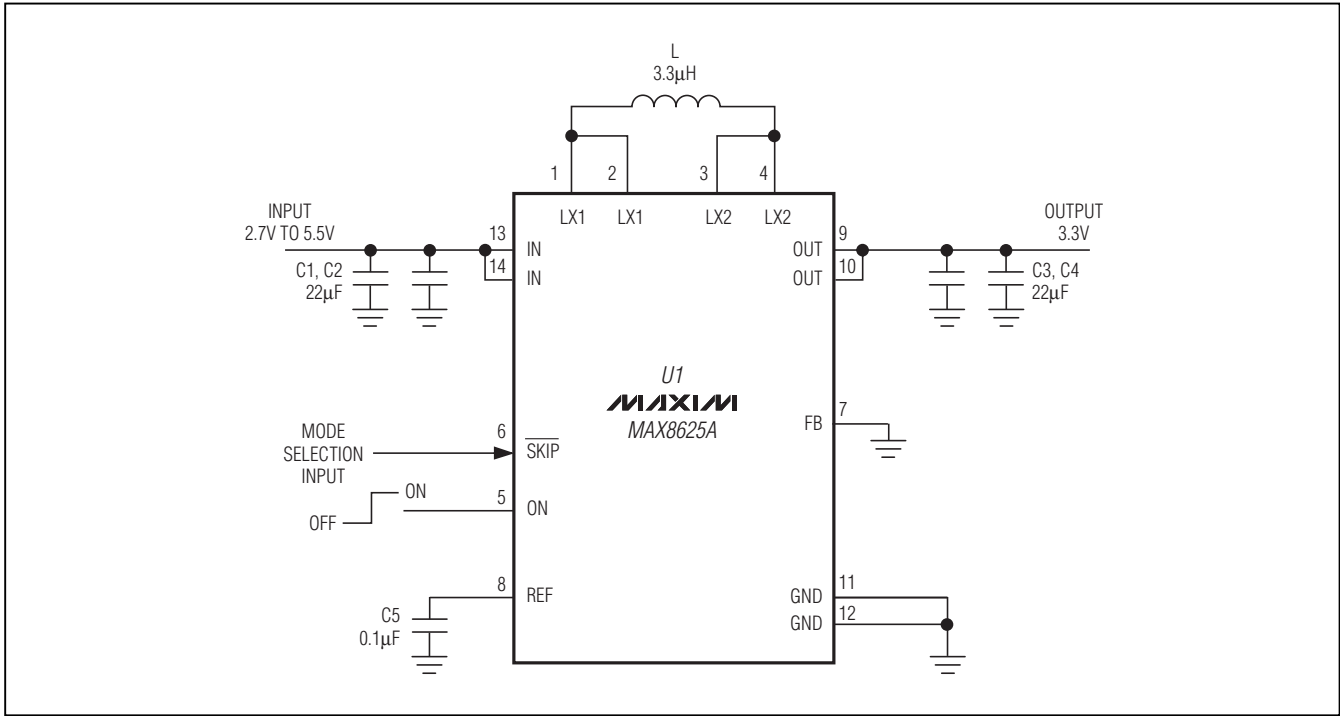

Figure 4. Typical Application Circuit (Fixed 3.3V Output)

Chip Information

PROCESS: BiCMOS

High-Efficiency, Seamless Transition, Step-Up/Down DC-DC Converter

Package Information

(The package drawing(s) in this data sheet may not reflect the most current specifications. For the latest package outline information, go to www.maxim-ic.com/packages.)

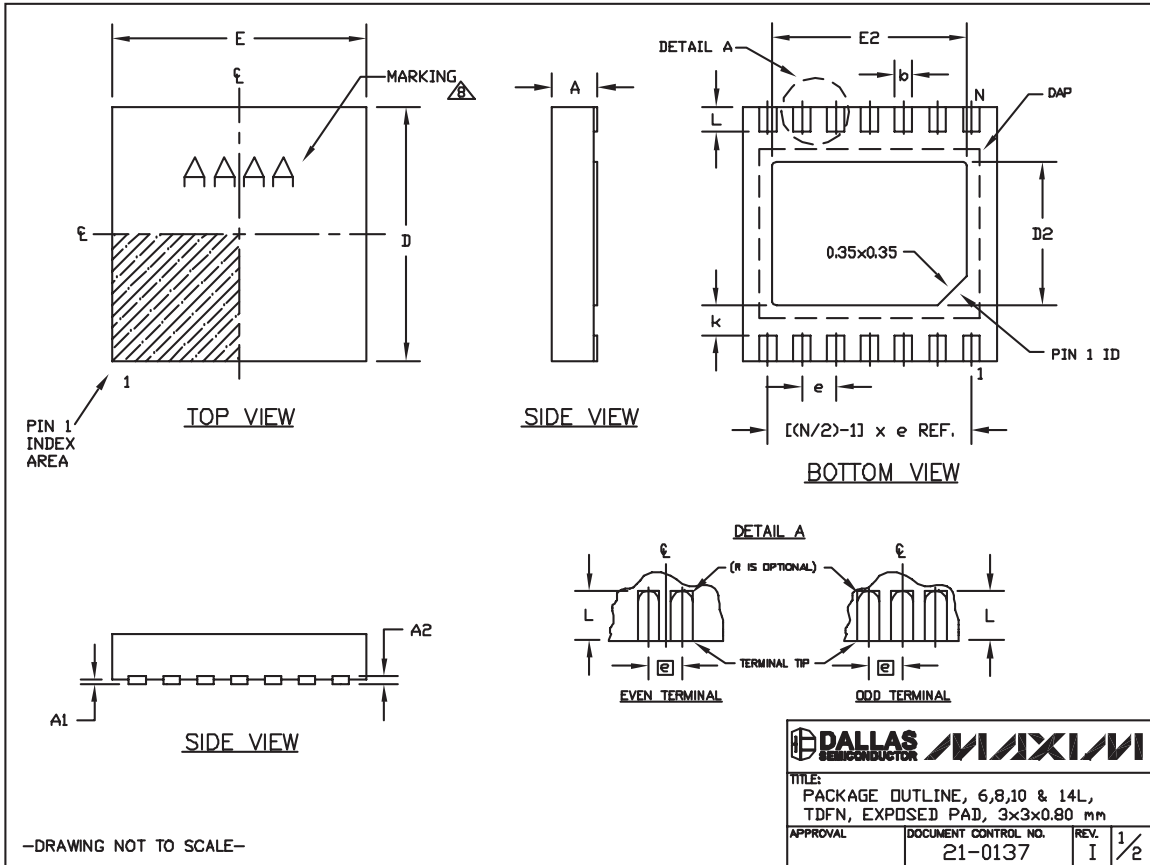

6, 8, & 10L, DFN THINLEPS

High-Efficiency, Seamless Transition, Step-Up/Down DC-DC Converter

MAX8625A

Package Information (continued)

(The package drawing(s) in this data sheet may not reflect the most current specifications. For the latest package outline information, go to www.maxim-ic.com/packages.)

COMMON DIMENSIONS			PACKAGE VARIATIONS							
SYMBOL	MIN.	MAX.	PKG. CODE	N	D2	E2	e	JEDEC SPEC	b	[(N/2)-1] x e
A	0.70	0.80	T633-2	6	1.50±0.10	2.30±0.10	0.95 BSC	MO229 / WEEA	0.40±0.05	1.90 REF
D	2.90	3.10	T833-2	8	1.50±0.10	2.30±0.10	0.65 BSC	MO229 / WEEC	0.30±0.05	1.95 REF
E	2.90	3.10	T833-3	8	1.50±0.10	2.30±0.10	0.65 BSC	MO229 / WEEC	0.30±0.05	1.95 REF
A1	0.00	0.05	T1033-1	10	1.50±0.10	2.30±0.10	0.50 BSC	MO229 / WEED-3	0.25±0.05	2.00 REF
L	0.20	0.40	T1033-2	10	1.50±0.10	2.30±0.10	0.50 BSC	MO229 / WEED-3	0.25±0.05	2.00 REF
k	0.25 MIN.		T1433-1	14	1.70±0.10	2.30±0.10	0.40 BSC	----	0.20±0.05	2.40 REF
A2	0.20 REF.		T1433-2	14	1.70±0.10	2.30±0.10	0.40 BSC	----	0.20±0.05	2.40 REF

NOTES:

- ALL DIMENSIONS ARE IN mm. ANGLES IN DEGREES.
- COPLANARITY SHALL NOT EXCEED 0.08 mm.
- WARPAGE SHALL NOT EXCEED 0.10 mm.
- PACKAGE LENGTH/PACKAGE WIDTH ARE CONSIDERED AS SPECIAL CHARACTERISTIC(S).
- DRAWING CONFORMS TO JEDEC MO229, EXCEPT DIMENSIONS "D2" AND "E2", AND T1433-1 & T1433-2.
- "N" IS THE TOTAL NUMBER OF LEADS.
- NUMBER OF LEADS SHOWN ARE FOR REFERENCE ONLY.
-  MARKING IS FOR PACKAGE ORIENTATION REFERENCE ONLY.

—DRAWING NOT TO SCALE—

		
TITLE: PACKAGE OUTLINE, 6,8,10 & 14L, TDFN, EXPOSED PAD, 3x3x0.80 mm		
APPROVAL	DOCUMENT CONTROL NO. 21-0137	REV. I 2/2

Maxim cannot assume responsibility for use of any circuitry other than circuitry entirely embodied in a Maxim product. No circuit patent licenses are implied. Maxim reserves the right to change the circuitry and specifications without notice at any time.

Maxim Integrated Products, 120 San Gabriel Drive, Sunnyvale, CA 94086 408-737-7600 _____ 15