

Features

- Small outline SOT23-6 package
- Primary-side current sensing and regulation without an opto-coupler
- Wide AC input range – from 85VAC to 265VAC
- High Power Factor of >0.9 without additional circuitry
- Accurate constant current ($< \pm 3\%$)
- Low start-up current which reduces power dissipation
- Full protection functions for enhanced safety:
 - Gate driver output voltage clamp
 - VCC over voltage protection – VCC OVP
 - VCC under-voltage lockout with hysteresis – VCC UVLO
 - Output LED string over current protection
 - Output LED string short / open protection
 - On-chip over temperature protection – OTP

Applications

- General illumination
- E26/27, T5/T8 LED Lamp
- Other LED Lighting Applications

General Description

The HT7L5600 is a single-stage, isolated, primary-side offline LED lighting controller that achieves a high power factor. Power control is implemented by controlling an external MOSFET and accurate LED constant current regulation from the primary-side information. This can significantly simplify the LED lighting system design by eliminating the secondary-side feedback components and the normally required opto-coupler. The extremely low start-up current and quiescent current reduces the total power consumption to provide a high efficiency solution for lighting applications.

The HT7L5600 provides several protection functions, which include VCC Under Voltage Lockout (UVLO), Over Current Protection (OCP), Output LED String Open Protection, Output LED String Short Protection, VCC Over Voltage Protection (OVP) and Leading-Edge Blanking (LEB) for current sensing. Additionally and to ensure system reliability, the device includes a fully integrated thermal protection function. To protect the external power MOSFET from being damaged by an over voltage, the device DRV pin voltage is clamped to about 16V.

The high level of functional integration minimises the external component count giving major advantages in terms of cost and circuit board area. The device is supplied in a SOT23-6 package.

Application Circuits

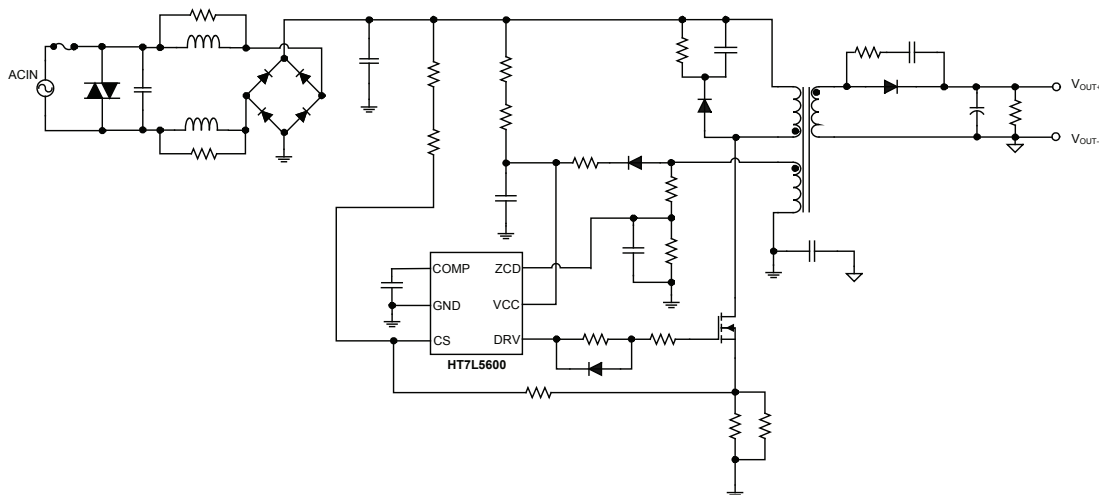

Block Diagram

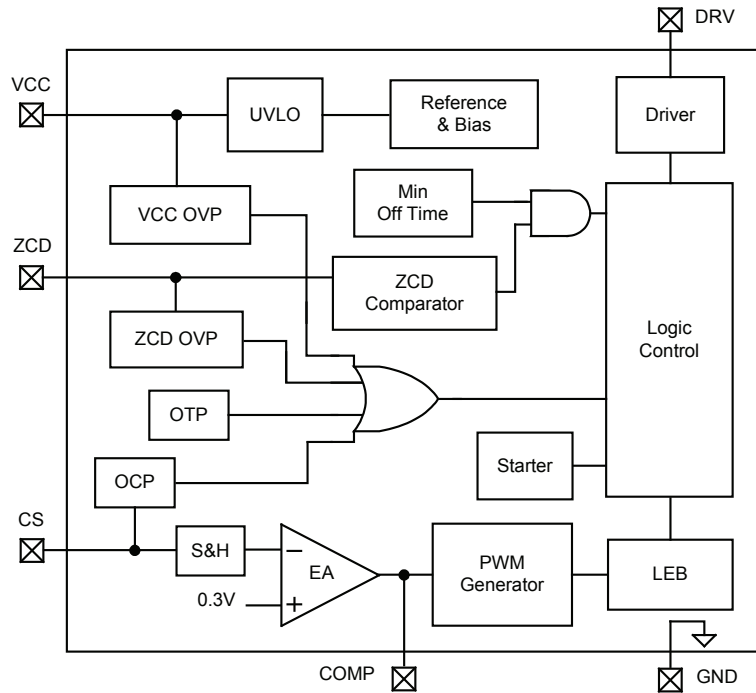

Pin Assignment

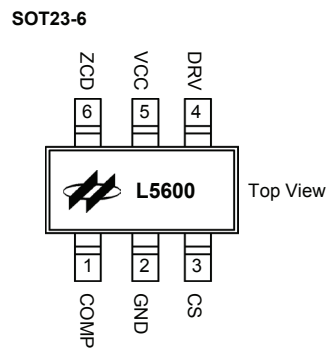

Pin Description

Pin No.	Symbol	Description
1	COMP	Loop compensation pin. A capacitor should be placed between COMP and GND.
2	GND	Ground pin
3	CS	Current sense pin. A resistor is connected to sense the MOSFET current.
4	DRV	Gate drive output for driving external power MOSFETs
5	VCC	Power supply pin
6	ZCD	Connected to a resistor divider from the auxiliary winding to sense the output voltage.

Absolute Maximum Ratings

Parameter	Range
VCC supply voltage	-0.3V~27V
Input voltage to CS pin	-0.3V~6V
Output voltage at COMP pin	-0.3V~6V
Maximum current at ZCD pin	3mA (source), 3mA (sink)
Maximum operating junction temperature	150°C
Storage temperature range	-55°C~150°C

Recommended Operating Ranges

Parameter	Range
VCC Supply voltage	10V~20V
Operating junction temperature	-40°C~125°C

Electrical Characteristics

 (V_{CC}=12V, Ta=25°C)

Symbol	Parameter	Test Condition	Min	Typ	Max	Unit
Power Supply (VCC Pin)						
V _{CC_ON}	UVLO _{ON}	—	—	18	—	V
V _{CC_OFF}	UVLO _{OFF}	—	—	7.5	—	V
V _{CC_HYS}	UVLO Hysteresis	—	10	—	—	V
V _{OVP1}	VCC OVP Trip Point	—	21.5	24	26.5	V
I _{START}	Start-up Current	Before turn-on, @V _{CC} =UVLO _{ON} - 1V	—	10	20	μA
I _Q	Quiescent Current	No switching	—	0.7	1	mA
I _{CC}	Operating Current	@70kHz, Co=1nF	—	1.3	2	mA
Error Amplifier						
V _{FB}	Feedback Reference Voltage	Ta=25°C	291	300	309	mV
Current Sense Comparator						
t _{LEB}	Leading Edge Blanking Time	—	—	400	—	ns
V _{OCP}	Current Limit Threshold	—	—	1.55	—	V
V _{SCP}	ZCD Pin Short Circuit Protection Threshold	—	—	0.4	—	V
Zero Current Detector						
V _{ZCDH}	Upper Clamp Voltage	I _{ZCD} =2.5mA	—	6.1	—	V
V _{ZCDL}	Lower Clamp Voltage	I _{ZCD} = -2.5mA	—	-0.7	—	V
V _{ZCDA}	Positive-Going Edge	—	—	150	—	mV
V _{ZCDT}	Negative-Going Edge	—	—	50	—	mV
V _{OVP2}	ZCD pin OVP Level	—	2.88	3.2	3.52	V
t _{B_OVP}	OVP Detection Blanking Time	—	—	1	—	μs
Starter						
t _{START}	Start Timer Period	—	—	40	—	μs
t _{OFF}	Minimum Off Time	—	—	6.4	—	μs
Over Temperature Protection						
OTP	Over Temperature Trip Point	—	—	150	—	°C
Gate Driver						
t _R	Rising Time	C _{LOAD} =1nF, 10%~90%	—	50	—	ns
t _F	Falling Time	C _{LOAD} =1nF, 10%~90%	—	50	—	ns
I _{Source}	Source Current	—	—	300	—	mA
I _{Sink}	Sink Current	—	—	300	—	mA
V _{G_CLAMP}	Gate Clamp Voltage	@ V _{CC} = 20V	—	16	19.5	V

Typical Performance Characteristics

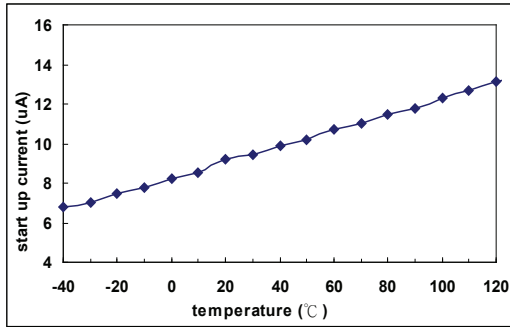

Figure 1. Start-up current vs. temperature

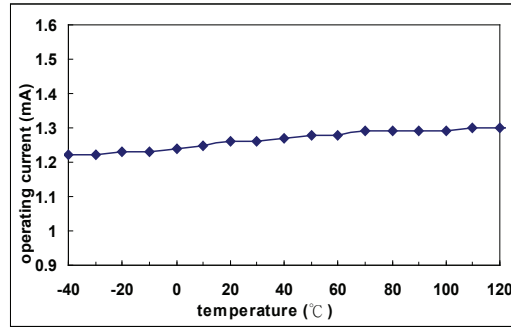

Figure 2. Operation current vs. temperature

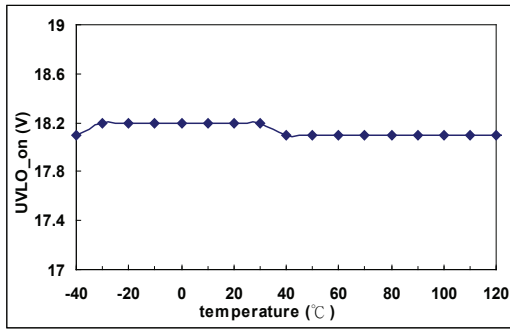

Figure 3. UVLO_on vs. temperature

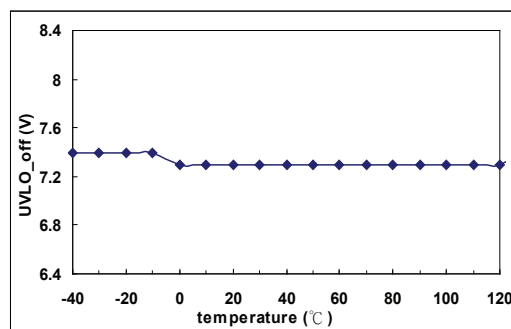

Figure 4. UVLO_off vs. temperature

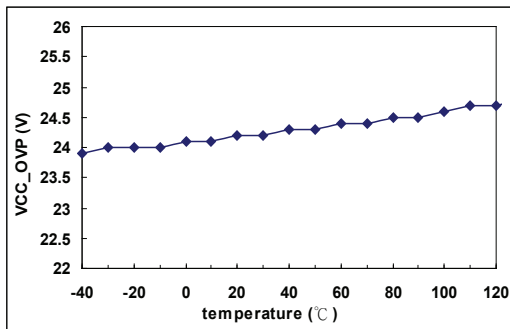

Figure 5. VCC_OVP vs. temperature

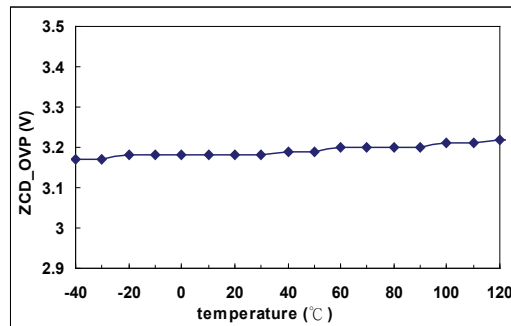

Figure 6. ZCD_OVP vs. temperature

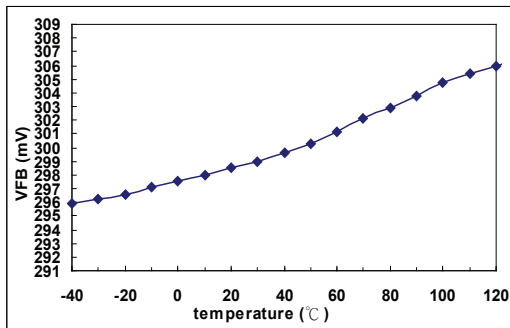

Figure 7. VFB vs. temperature

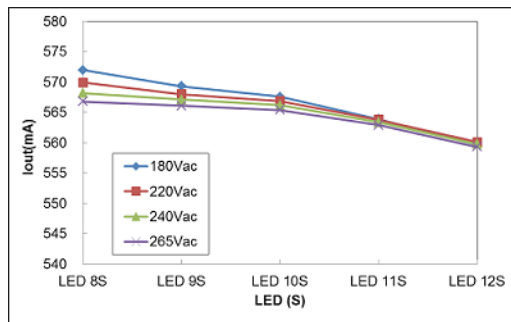

Figure 8. Iout vs. LED Series

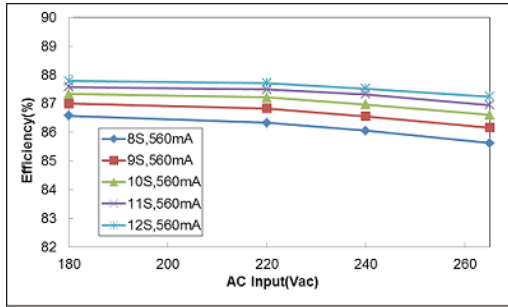

Figure 9. Efficiency vs. AC Voltage

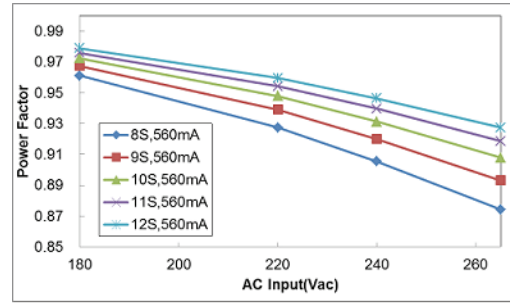

Figure 10. Power Factor (PF) vs. AC Voltage

Functional Description

The HT7L5600 is a single-stage primary-side offline LED controller designed for isolated LED lighting applications. The device can achieve high Power Factor values and low THD values without resorting to additional circuits and can also generate high accuracy LED drive currents with very few external components.

Start-up Current

A very low start-up current, I_{START} , allows users to select a larger start-up resistor value which reduces power dissipation.

Power Factor Correction

High power factor is achieved by constant on-time operation. To implement constant on-time control, a $0.47\mu\text{F}$ capacitor is placed between the COMP pin and ground.

Constant Current Control

The HT7L5600 accurately regulates the LED current by sensing the primary-side information. The LED current can be set as follows:

$$I_{OUT} \approx \frac{1}{2} \times \frac{V_{FB}}{R_{CS}} \times \frac{N_P}{N_S}$$

Where N_P is the primary winding and N_S is the secondary winding; $V_{FB}(=300\text{mV})$ is the internal voltage reference and R_{CS} is the external current sensing resistor.

VCC Under Voltage Lockout – UVLO

The device has an integrated UVLO function which includes 10V of hysteresis. The PWM controller will switch on when the VCC voltage exceeds 18V. It will switch off when the VCC voltage is less than 7.5V. The hysteresis characteristics will ensure that the device can be powered by an input capacitor during start-up. When the output voltage increases to a certain value after start-up, VCC will be charged by an output through an auxiliary winding.

Boundary Conduction Mode – BCM

The power MOSFET is turned on by inductor current zero-crossing detection. The current zero-crossing can be detected by a ZCD voltage. When the inductor current is at the zero crossing point, the voltage on the ZCD pin will drop rapidly. The HT7L5600 then detects the falling edge and turns on the Power MOSFET. The boundary conduction mode provides low turn-on switching losses and high conversion efficiency.

Leading-Edge Blanking – LEB on CS

At each turn on time of the external power MOSFET, a spike will inevitably be generated at the sense resistor. To prevent faulty triggering, a 400ns leading-edge blank time will be generated. During this blanking period, the current-limit comparator is disabled and will therefore not be able to switch off the gate driver.

Gate Driver Clamp

The DRV pin is connected to the gate of external MOSFET to switch it on and off. To protect the external power MOSFET from being over-stressed, the gate driver output is clamped to 16V.

Over Voltage Protection – OVP on VCC

In order to prevent PWM controller damage, the device includes an OVP function for VCC. Should the VCC voltage exceed the OVP threshold voltage of 24V, the PWM controller will cease operation immediately. When the VCC voltage falls below the UVLO off level, the controller will reset.

LED Open Protection – ZCD OVP

The ZCD pin voltage is set by a resistor divider R_{TOP} (top resistor), R_{BOT} (bottom resistor) and an auxiliary winding due to the coupling polarity between the auxiliary winding and the secondary winding of the transformer. Once the ZCD voltage exceeds 3.2V after a blanking time about 1 μ s to allow the leakage inductance ringing to be fully damped, ZCD OVP is triggered. The device will then stop switching but it can be reset by re-starting the voltage on the VCC pin. The OVP voltage can be adjusted by the equation:

$$V_{OUT_OVP} = 3.2 \times \left(1 + \frac{R_{TOP}}{R_{BOT}}\right) \times \frac{N_S}{N_A} + V_D$$

Where N_S is the secondary winding, N_A is the auxiliary winding and V_D is the forward bias voltage of the secondary diode.

Over Current Protection – OCP

The HT7L5600 includes a CS pin over current protection function. An internal circuit detects the current level and should the current be larger than the over current protection threshold level, the gate output will then be fixed to a low level.

LED Short Protection – SCP

The output voltage drops when a number of LEDs in a string are shorted resulting in a voltage drop on VCC. Once VCC falls below 7.5V, the device will cease operation. Under such situations, the start-up operation will recharge the VCC pin through the start-up resistor and the device will enter the UVLO hiccup mode.

Thermal Protection

A thermal protection feature is included to protect the device from excessive heat damage. When the junction temperature exceeds a threshold of 150°C, the thermal protection function will turn off the DRV terminal immediately. When the VCC decreases below the UVLO off level, the controller will reset.

Package Information

Note that the package information provided here is for consultation purposes only. As this information may be updated at regular intervals users are reminded to consult the [Holtek website](#) for the latest version of the [Package/ Carton Information](#).

Additional supplementary information with regard to packaging is listed below. Click on the relevant section to be transferred to the relevant website page.

- Package Information (include Outline Dimensions, Product Tape and Reel Specifications)
- The Operation Instruction of Packing Materials
- Carton information

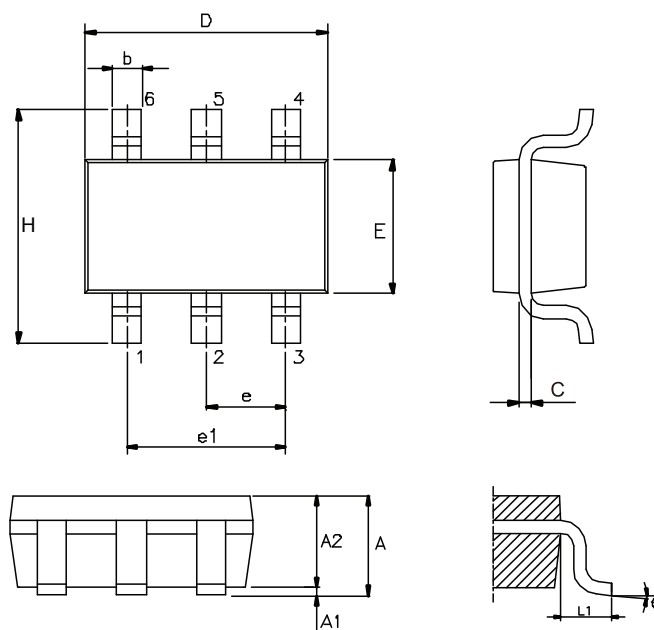
6-pin SOT23-6 Outline Dimensions

Symbol	Dimensions in inch		
	Min.	Nom.	Max.
A	—	—	0.057
A1	—	—	0.006
A2	0.035	0.045	0.051
b	0.012	—	0.020
C	0.003	—	0.009
D	—	0.114 BSC	—
E	—	0.063 BSC	—
e	—	0.037 BSC	—
e1	—	0.075 BSC	—
H	—	0.110 BSC	—
L1	—	0.024 BSC	—
θ	0°	—	8°

Symbol	Dimensions in mm		
	Min.	Nom.	Max.
A	—	—	1.45
A1	—	—	0.15
A2	0.90	1.15	1.30
b	0.30	—	0.50
C	0.08	—	0.22
D	—	2.90 BSC	—
E	—	1.60 BSC	—
e	—	0.95 BSC	—
e1	—	1.90 BSC	—
H	—	2.80 BSC	—
L1	—	0.60 BSC	—
θ	0°	—	8°

Copyright© 2015 by HOLTEK SEMICONDUCTOR INC.

The information appearing in this Data Sheet is believed to be accurate at the time of publication. However, Holtek assumes no responsibility arising from the use of the specifications described. The applications mentioned herein are used solely for the purpose of illustration and Holtek makes no warranty or representation that such applications will be suitable without further modification, nor recommends the use of its products for application that may present a risk to human life due to malfunction or otherwise. Holtek's products are not authorized for use as critical components in life support devices or systems. Holtek reserves the right to alter its products without prior notification. For the most up-to-date information, please visit our web site at <http://www.holtek.com.tw>.