

## D-Sub Standard Board Mount Connectors

Amphenol's D-Subminiature connectors are part of an industry standard for applications requiring robust and reliable connectors. These proven D-Subminiature connectors are one of the most popular Input/Output interconnects, addressing a wide variety of applications in Telecommunications, Data, Consumer Industrial, Military, Instrumentation and Medical. Since many years Amphenol has been offering a wide range of D-Subminiature connectors to meet various design requirements including those in harsh environment.

The standard density D-Subminiature series are widely used for numerous applications in many market segments. Amphenol offers Delta-D (single shell design) and Frugal-D (two shell design) under this category. Standard density D-subminiature PCB mount connectors available in straight and angled version. They come with a large number of mounting options.



### TARGET MARKETS



### FEATURES

- A Basic I/O connector comes with five shell size and housing design
- Has a D-shaped shell design
- Meets DIN 41652 and MIL-C-24308 dimensional standards
- Available in Straight, Angle, Wire Wrap terminations
- Delta-D design (1 shell + 1 housing) with stamped & formed contacts
- Various PCB and Panel mounting accessory options available
- Lead-free and RoHS compliant

### BENEFITS

- Most popular Rugged and sturdy I/O connector
- Supports the need for polarisation
- Interchangeable and intermateable with other makes
- Support different PCB mounting requirements
- Price competitive
- Wide variety of choices for secure connection
- Meets environmental, health and safety requirements

## ▶ D-Sub Standard Board Mount Connectors

# RIGHT ANGLE SOLDER TO BOARD



UL RECOGNISED FILE E66906

- In compliance with DIN 41652

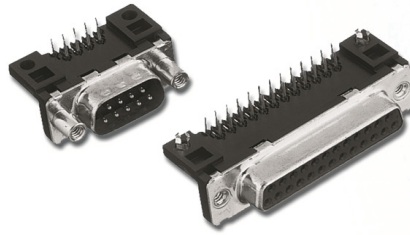

## ORDERING INFORMATION

<b>D</b>	<b>25</b>	<b>P</b>	<b>13A</b>	<b>4</b>	<b>GV</b>	<b>00LF</b>
Series:						
Number of Contacts						
09						
15						
25						
37						
Contacts						
Pin	P					
Socket	S					
Termination				Code		
Type	Footprint/ Pitch	Length of Termination	PCB Thickness			
Right angled – Europe standard	10.4/ 2.54mm	2.90	1.6	13A		✓
Right angled – Europe standard	10.4/ 2.54mm	3.70	2.4 and 1.6	13B		
Right angled – Europe standard	10.4/ 2.84mm	2.90	1.6	23A		
Right angled – Europe standard	10.4/ 2.84mm	3.70	2.4 and 1.6	23B		
Right angled – US standard	8.08/ 2.84mm	3.18	1.6	33E		✓
Durability						
Standard class (≥200 mating/ unmating)				4		
High performance class (≥500 mating/unmating)				6		
RoHS Status						
Standard, RoHS compatible					00LF	
Mouting Options						
Standard hole					PA	
Threaded insert M3					PL	
Threaded insert UNC 4–40					PX	
Female screw UNC 4–40					PV	
Harpoons + insert M3 + elec. continuity					GL	
Harpoons + insert UNC 4–40 + elec. continuity					GX	✓
Harpoons + female screw UNC 4–40+ elec. continuity					GV	✓
Harpoons + female screw M3 + elec. continuity					GI	
Elec. continuity					UA	
Insert M3 + elec. continuity					UL	
Insert UNC 4–40 + elec. continuity					UX	
Female screw UNC 4–40 + elec. continuity					UV	

## ► D-Sub Standard Board Mount Connectors

### SPECIFIC DIMENSIONS

#### EUROPE STANDARD

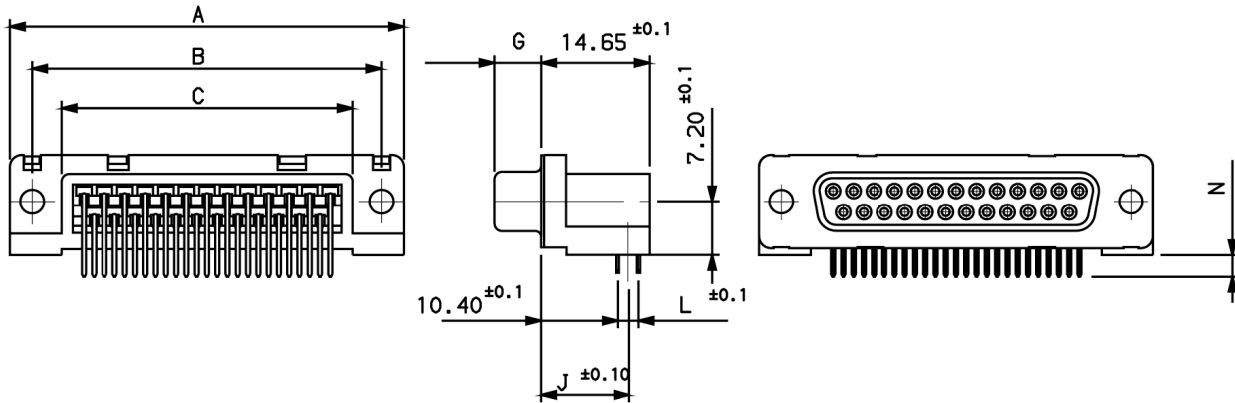

#### US STANDARD

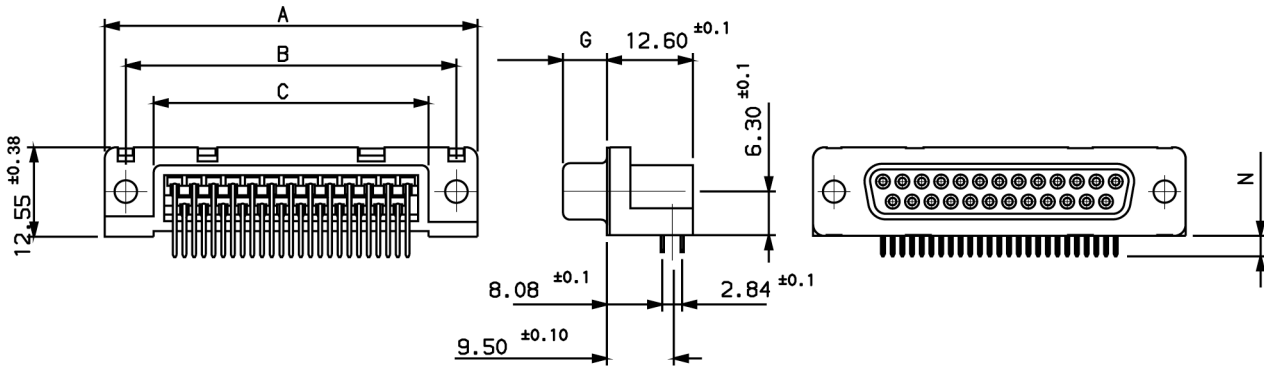

		A $\pm 0,38$	B $\pm 0,12$	C $\pm 0,10$	G $-0/+0,25$	J $\pm 0,10$		L $\pm 0,10$		N $\pm 0,30$		
						Termination		Termination		Termination Length		
						13	23	13	23	13A 23A	13B 23B	33E
09	P	30.81	24.99	16.96	5.90 $-0/+0,15$	11.67	11.82	2.54	2.84	2.90	3.70	3.18
	S	30.81	24.99	16.96	6.05	11.67	11.82	2.54	2.84	2.90	3.70	3.18
15	P	39.14	33.32	25.18	5.90 $-0/+0,15$	11.67	11.82	2.54	2.84	2.90	3.70	3.18
	S	39.14	33.32	25.18	6.05	11.67	11.82	2.54	2.84	2.90	3.70	3.18
25	P	53.03	47.04	39.12	5.70	11.67	11.82	2.54	2.84	2.90	3.70	3.18
	S	53.03	47.04	39.12	6.05	11.67	11.82	2.54	2.84	2.90	3.70	3.18
37	P	69.32	63.50	55.68	5.70	11.67	11.82	2.54	2.84	2.90	3.70	3.18
	S	69.32	63.50	55.68	6.05	11.67	11.82	2.54	2.84	2.90	3.70	3.18

Dimensions in mm

## ► D-Sub Standard Board Mount Connectors

# STRAIGHT SOLDER TO BOARD

**UL** <sup>®</sup> **UL RECOGNISED FILE E66906**



## ORDERING INFORMATION

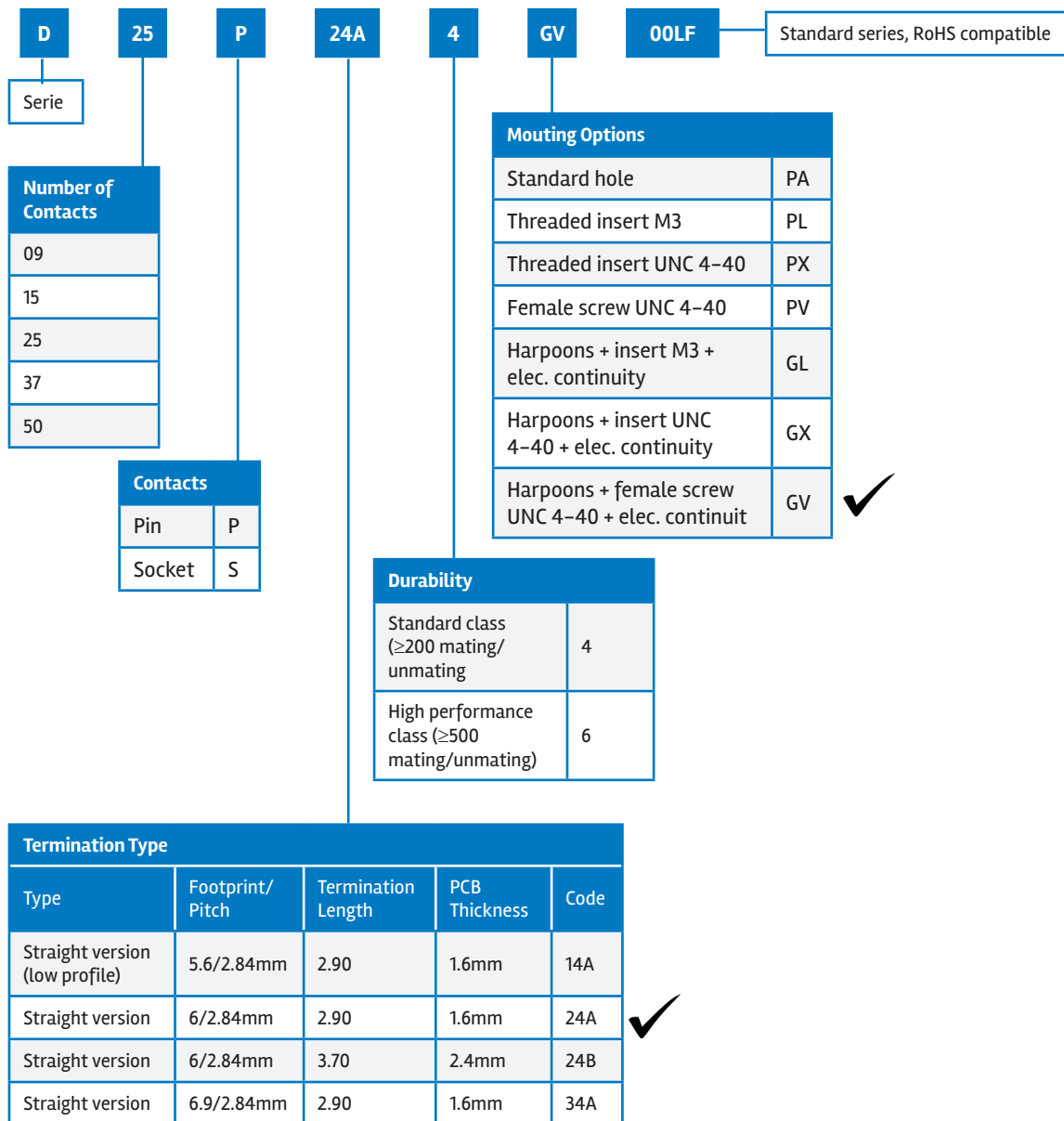

Preferred Option ✓

## ► D-Sub Standard Board Mount Connectors

### SPECIFIC DIMENSIONS

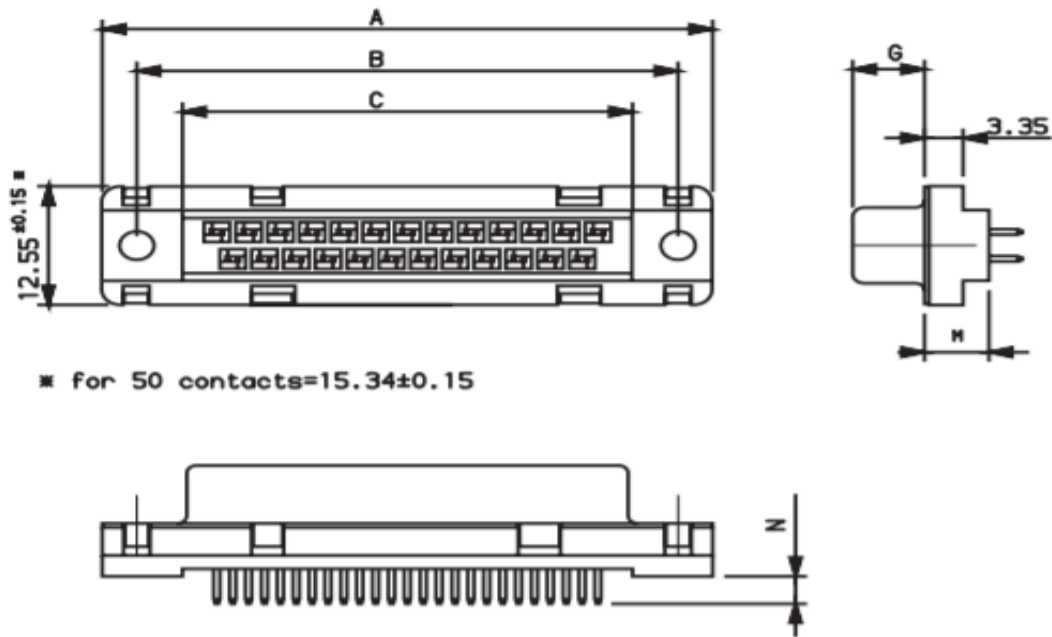

Dimensions										
		A <sup>±0,38</sup>	B <sup>±0,12</sup>	C <sup>±0,10</sup>	G <sup>-0/+0,25</sup>	M <sup>±0,10</sup>			N <sup>±0,30</sup>	
						Terminal			Terminal Length	
						14	24	34	14A 24A 34A	24B
09	P	30.81	24.99	16.96	5.90 <sup>-0/+0,15</sup>	5.60	6.00	6.90	2.90	3.70
	S	30.81	24.99	16.96	6.05	5.60	6.00	6.90	2.90	3.70
15	P	39.14	33.32	25.18	5.90 <sup>-0/+0,15</sup>	5.60	6.00	6.90	2.90	3.70
	S	39.14	33.32	25.18	6.05	5.60	6.00	6.90	2.90	3.70
25	P	53.03	47.04	39.12	5.70	5.60	6.00	6.90	2.90	3.70
	S	53.03	47.04	39.12	6.05	5.60	6.00	6.90	2.90	3.70
37	P	69.32	63.50	55.68	5.70	5.60	6.00	6.90	2.90	3.70
	S	69.32	63.50	55.68	6.05	5.60	6.00	6.90	2.90	3.70
50	P	67.10	61.11	54.11	5.70	5.60	6.00	6.90	2.90	3.70
	S	67.10	61.11	54.11	6.05	5.60	6.00	6.90	2.90	3.70

Dimensions in mm



## ▶ D-Sub Standard Board Mount Connectors

# MACHINED CONTACTS



UL RECOGNISED FILE E 66906

- DP series is designed for high performance applications, particularly in the field of telecommunications: data transmission, private automatic branch switching, telecom (LNZ listed)

- It features machined contacts and is available with straight spills, angled spills, and wire wrap terminations

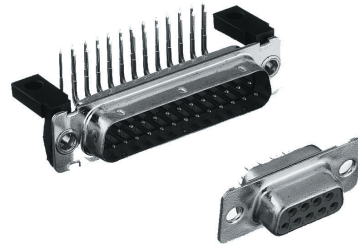

## PART NUMBER SELECTOR

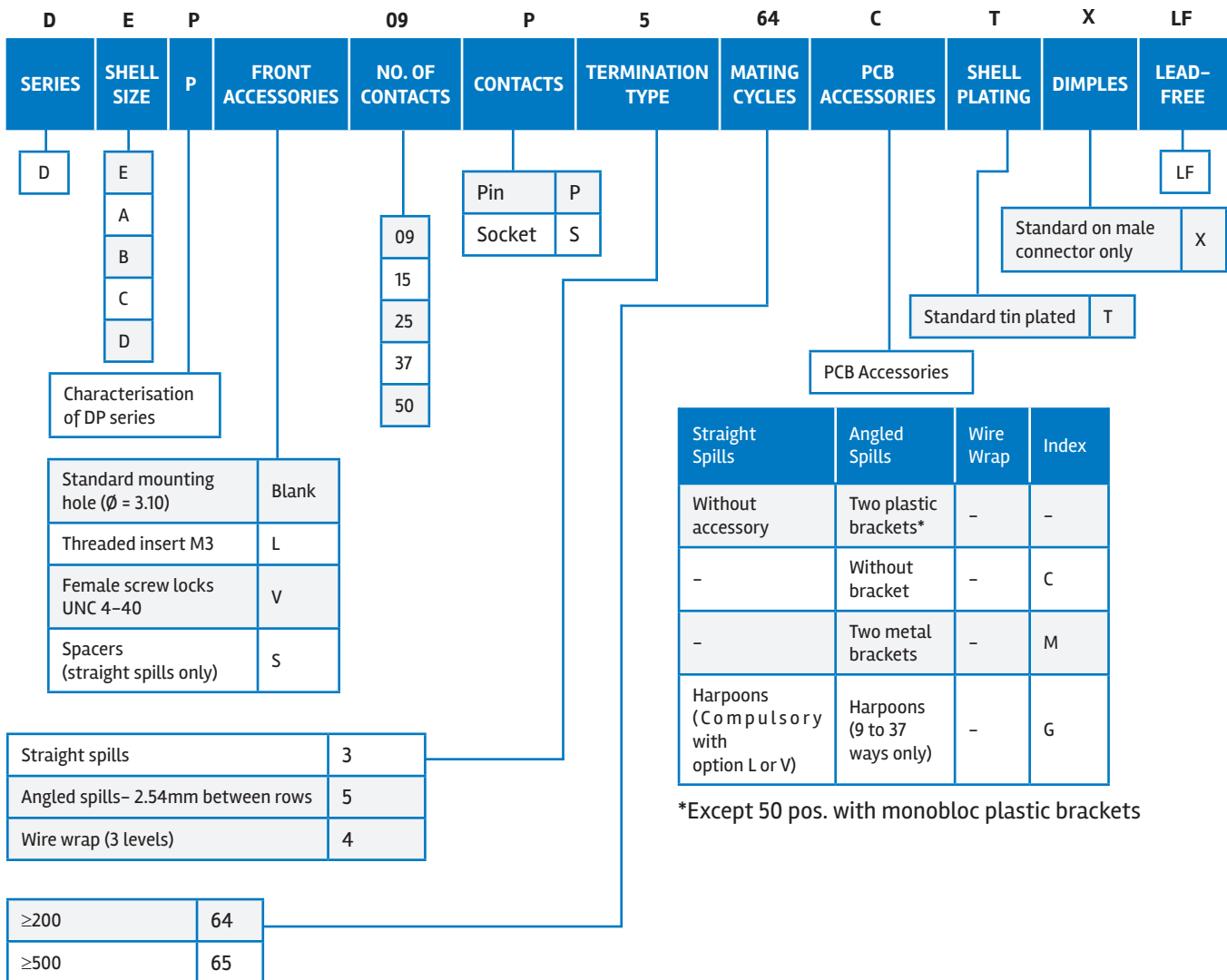

\*Except 50 pos. with monobloc plastic brackets

## ► D-Sub Standard Board Mount Connectors

### SPECIFIC DIMENSIONS

Wire Wrap

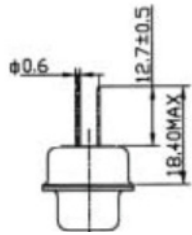

Right Angle Spills

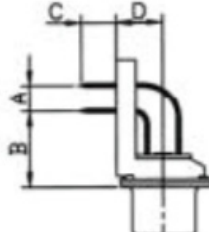

Straight Spills

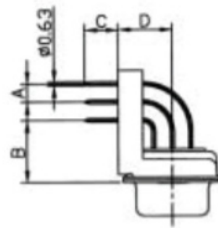
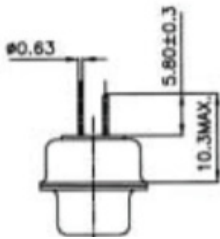

Dimension		Termination Code
		5
A		2.54
$B \pm 0.1$		10.30
$C \pm 0.5$		4.00
$D \pm 0.19$	9 to 37 contacts	7.20
	50 contacts	8.60



## ▶ D-Sub Standard Board Mount Connectors

### TARGET MARKETS/APPLICATIONS



Asymmetric Digital Subscriber Line  
(ADSL)  
Base Station  
Switching  
Transmission



Set-top Box



Desktop and Laptop  
Storage System  
Router and Server



Automotive Diagnostics  
Control Drives  
Energy Meter  
Gaming Machine  
Test Equipment  
Office Automation  
POS & Handheld terminal  
Power Supplies  
Parking Meter  
Printer and Copier  
Renewable Energy  
Robotics  
Surveillance Camera  
Avionics



Medical Instrument



Military Equipment

IN0DSUBSTDBMT082IEA4