

MPB252010T Series Specification

1 Scope: This specification applies to Multilayer power inductors

2 Part Numbering:

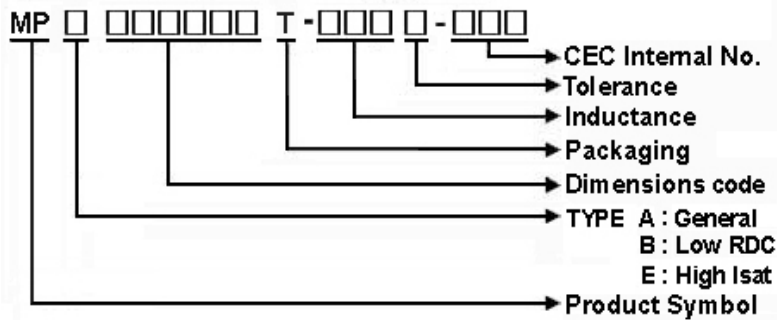

3 Rating:

Operating Temperature: $-55^{\circ}\text{C} \sim 125^{\circ}\text{C}$ (Including self - temperature rise)

Storage Temperature: $-55^{\circ}\text{C} \sim 125^{\circ}\text{C}$ (after PCB)

$-5^{\circ}\text{C} \sim 40^{\circ}\text{C}$, Humidity 40%~70% (before PCB)

4 Marking:



5 Standard Testing Condition

	Unless otherwise specified	In case of doubt
Temperature	Ordinary Temperature(15 to 35°C)	20 to 30°C
Humidity	Ordinary Humidity(25 to 85% RH)	50 to 80 %RH

MPB252010T Series Specification

6 Configuration and Dimensions:

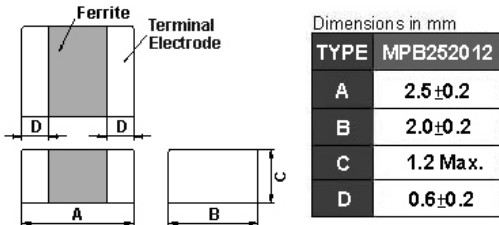

7 Electrical Characteristics:

Part No.	Inductance (μ H)	Test Freq.	RDC (Ω)±30%	Isat (mA)Max.	Irms (mA)Max.	Tolerance (±%)
MPB252012T-R47□-NA2	0.47	3MHz,200mV	0.04	1500	1800	20,30
MPB252012T-1R0□-NA2	1	3MHz,200mV	0.05	950	1600	20,30
MPB252012T-1R5□-NA2	1.5	3MHz,200mV	0.07	900	1400	20,30
MPB252012T-2R2□-NA2	2.2	3MHz,200mV	0.1	700	1200	20,30
MPB252012T-3R3□-NA2	3.3	3MHz,200mV	0.12	500	1100	20,30
MPB252012T-4R7□-NA2	4.7	3MHz,200mV	0.14	350	1000	20,30
MPB252012T-6R8□-NA2	6.8	3MHz,200mV	0.16	250	900	20,30

NOTE: □-tolerance M=±20% / T=±30%

1. Operating temperature range — 5 5 °C ~ 1 2 5 °C (Including self - temperature rise)
2. Isat for Inductance drop 30% from its value without current.
3. I rms for a 40°C temperature rise from 25°C ambient with current.

MPB252010T Series Specification

8 MPB252012T Series

8.1 Construction:

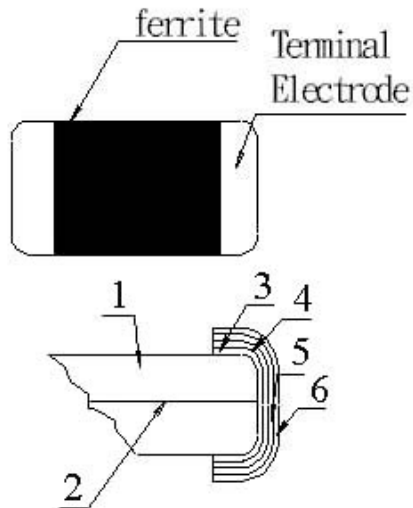

8.2 Material List:

No	Part	Material
1	Ferrite Substance	NiO-CuO-ZnO-Ferrite
2	Silver electrode	Ag
3	Silver electrode	Ag
4	Cu plating	Cu
5	Ni plating	Ni
6	Sn plating	Sn

MPB252010T Series Specification

7 Reliability Of Ferrite Multilayer power inductors

1-1. Mechanical Performance

No	Item	Specification	Test Method
1-1-1	Flexure Strength	The forces applied on the right conditions must not damage the terminal electrode and the ferrite	Test device shall be soldered on the substrate Substrate Dimension: 100x40x1.6mm Deflection: 2.0mm Keeping Time: 30sec
1-1-2	Vibration		Test device shall be soldered on the substrate Oscillation Frequency: 10 to 55 to 10Hz for 1min Amplitude: 1.5mm Time: 2hrs for each axis (X, Y & Z), total 6hrs
1-1-3	Resistance to Soldering Heat	Appearance: No damage More than 75% of the terminal electrode should be covered with solder. Inductance: within $\pm 20\%$ of	Pre-heating: 150°C, 1min Solder Composition: Sn/Ag3.0/Cu0.5(Pb-Free) Solder Temperature: 260 \pm 5°C Immersion Time: 10 \pm 1sec

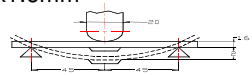

1-1-4

1-1-5

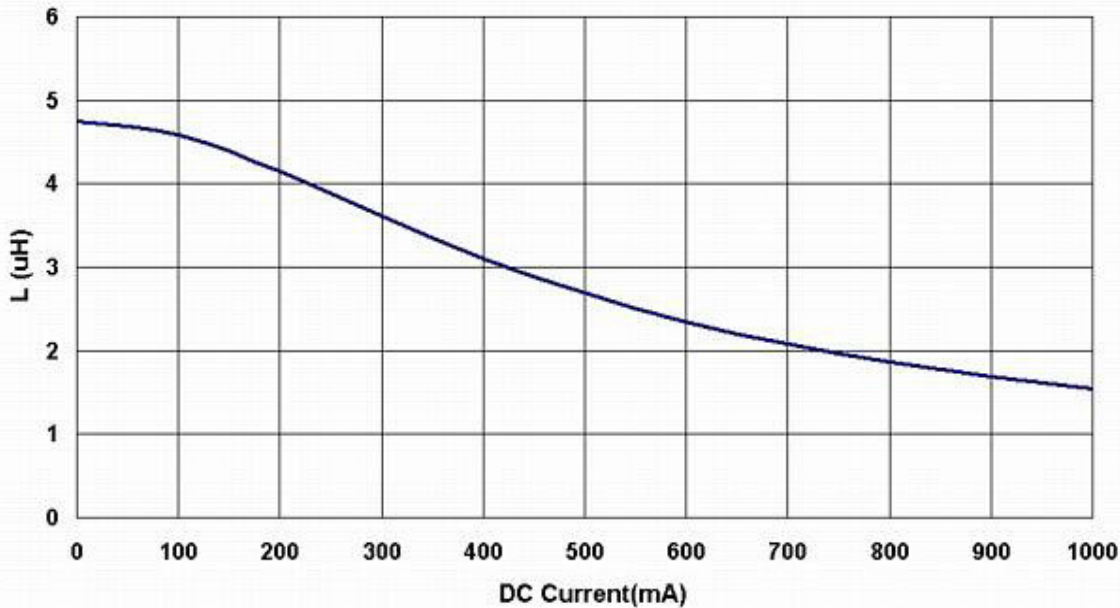

1-2.E

No

1-2-1

Time (min)
30
3
30
3
1 for 24hrs

1-2-2	Humidity Resistance	Temperature: 40 \pm 2°C Relative Humidity: 90 ~ 95% / Time: 1000hrs Measured after exposure in the room condition for 24hrs
1-2-3	High Temperature Resistance	Temperature: 125 \pm 3°C Relative Humidity: 0% / Time: 1000hrs Measured after exposure in the room condition for 24hrs
1-2-4	Low Temperature Resistance	Temperature: -55 \pm 3°C Relative Humidity: 0% / Time: 1000hrs Measured after exposure in the room condition for 24hrs

MPB252010T Series Specification

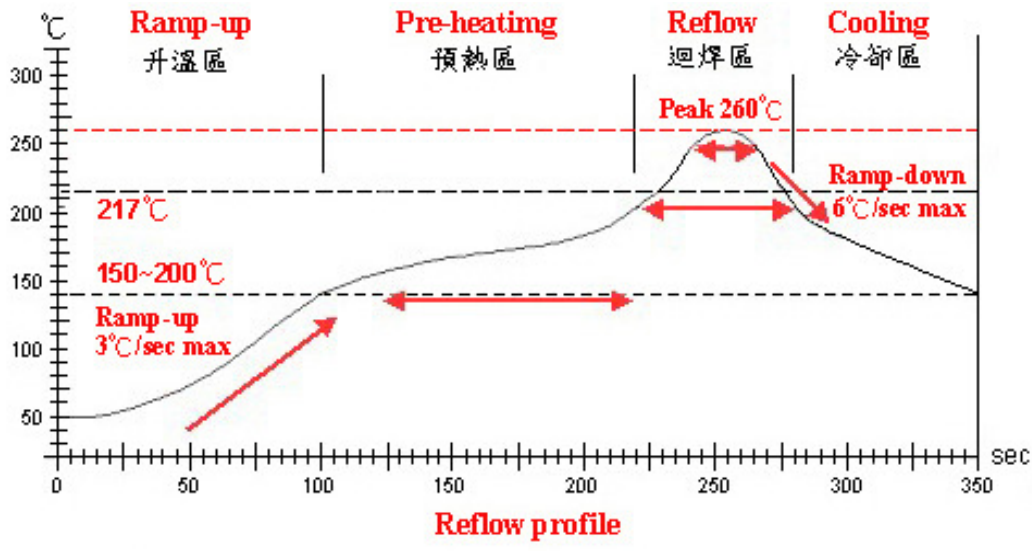

Lead-Free(LF) 標準溫度分析範圍

Refer to J-STD-020C

管制項目 Item.	升温區 Ramp-up	预热區 Pre-heating	迴焊區 Reflow	Peak Temp	冷却區 Cooling
溫度範圍 Temp.scope	R.T. ~ 150°C	150°C ~ 200°C	217°C	260±5°C	Peak Temp. ~ 150°C
標準時間 Time spec.	—	60 ~ 180 sec	60 ~ 150sec	20 ~ 40 sec	—
實際時間 Time result	—	75 ~ 100 sec	90 ~ 120sec	20 ~ 35 sec	—

NOTE :

1. Re-flow possible times : within 2 times
2. Nitrogen adopted is recommended while in re-flow

MPB252010T Series Specification

9 Packaging:

Chilisin

9.1 Packaging -Cover Tape

L	RDC	Isat	A	B	C	D
(uH)	(Ω)	(mA)	Max. m/m	m/m	m/m	m/m
4.7±20%						
3MHz						

THICKNESS : 0.1(0.004)MAX.

165° to 180°

TOP COVER TAPE

BASE TAPE

CAVITY

CARRIER

5.14						
5.15						
5.14						
5.15						
5.11	0.114	OK	2.49	1.98	1.15	0.44
5.15	0.114	OK	2.48	1.98	1.16	0.44
3.1	0.12	OK	2.48	1.99	1.15	0.43
5.14	0.115	OK	2.49	1.99	1.16	0.45
5.14	0.11	OK	2.49	1.98	1.16	0.44
5.12	0.114	OK	2.48	1.98	1.16	0.44

9.3 Reel Dimensions

L: Agilent E4991A+16197A

RDC: HP4338B

Isat : E4980A+42841A

Irms: Chroma DC Power Supply 62006P-100-25

MPB252010T Series Specification

11 Packaging:

11.4 Tape Dimensions in mm

The force for tearing off cover tape is 10 to 100 grams in the arrow direction.

12 Recommendation

TYPE	PCS/REEL
MP201205	4000
MP201210	3000
MP201610	3000
MP252010	3000
MP252012	3000

13 Note:

- Please note the dimensions when you use the product.
- Do not use the product in a high temperature environment.
- All the items and parameters in this product specification have been prescribed on the premise that our product is used for the purpose, under the condition and in the environment agreed upon between you and us. You are requested not to use our product deviating from such agreement.
- Please keep the distance between transformer/coil and other components (refer to the standard IEC 950)
- The moisture sensitivity level (MSL) of products is classified as level 1.

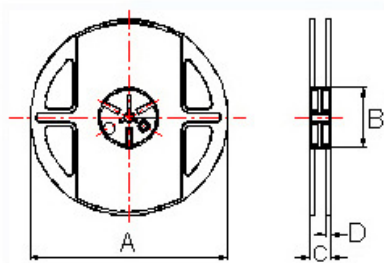

Dimensions in mm

TYPE	A	B	C	D
MP201205	178	60	12	1.5
MP201210	178	60	12	1.5
MP201610	178	60	12	1.5
MP252010	178	60	12	1.5
MP252012	178	60	12	1.5

to your specifications

MPB252010T Series Specification

14 Graph:

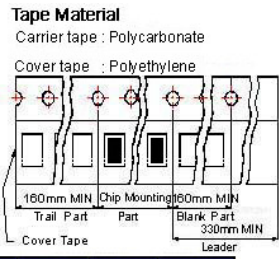
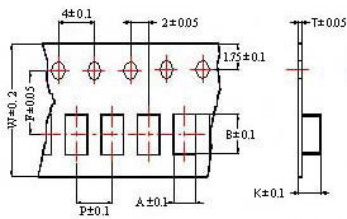

TYPE	A	B	T	W	P	F	K
MP201205	1.42	2.25	0.22	8	4	3.5	0.80
MP201210	1.45	2.25	0.22	8	4	3.5	1.04
MP201610	1.80	2.20	0.22	8	4	3.5	1.15
MP252010	2.25	2.80	0.25	8	4	3.5	1.35
MP252012	2.25	2.80	0.25	8	4	3.5	1.35

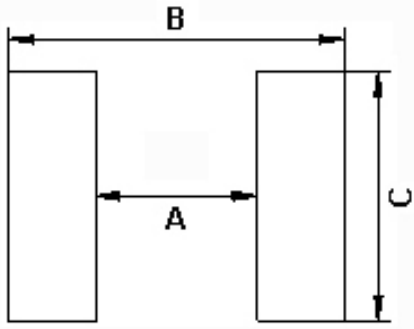

Dimensions in mm

TYPE	A	B	C
MP252012	1.3~1.9	2.7~3.5	2.0~2.6