

LP & LP-MD Series

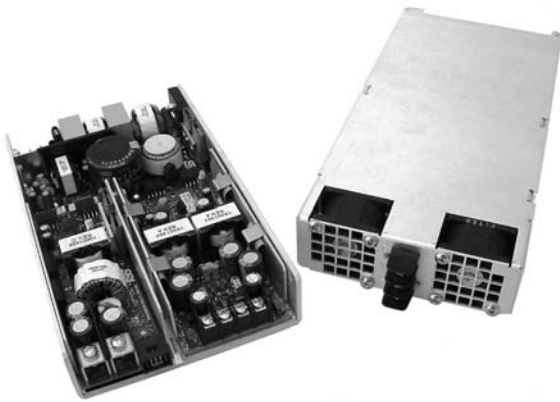

- Configurable for Fast Time to Market
- Industrial/IT & Medical Approvals
- All Outputs Isolated
- Low Profile 1U Applications
- Wide Voltage Adjustment Range
- SEMI F47 Certified
- Rugged Compact Design

Specification

Input

Input Voltage	• 90-264 VAC
Input Frequency	• 47-63 Hz
Inrush Current	• 20 A pk max
Power Factor	• Compliant with EN61000-3-2

Output

Output Voltage	• See module table
Output Voltage Trim	• $\pm 10\%$ min all modules. See module table for extended adjustment range
Hold Up Time	• 20 ms min
Line Regulation	• Typically 0.1%, maximum 0.3%
Load Regulation	• 1% max for single output modules & V1 of dual & triple output modules 2% max for V2 & V3 of dual & triple output modules A 10% load must be applied to output 1 of the high current dual module (U) & triple module (T) to achieve this figure
Ripple & Noise	• 50 mV or 1% pk-pk, whichever is greater, 20 MHz bandwidth
Overvoltage Protection	• 120-130% Vnom for single output & output 1 of high current dual modules (U) & triple modules (T)
Overload Protection	• <140% of nominal rating
Short Circuit Protection	• Foldback
Temperature Coefficient	• 0.03%/°C
Remote Sense	• Compensates for up to 0.5 V drop on single (S) output modules & output 1 of dual (U) & triple (T) output modules
Current Share	• Single wire parallel current share. See signals & controls page

General

Efficiency	• 75% typical at nominal input
Isolation	• 4000 VAC Input to Output 1500 VAC Input to Ground 50 VAC Output to Ground
Signals & Controls	• AC OK, DC OK, Global & Module Inhibit. See signals & controls page
MTBF	• 890 kHrs demonstrated

Environmental

Operating Temperature	• 0 °C to +70 °C, derate linearly from 100% at +50 °C to 50% at +70 °C for fan versions. See airflow curves for U-channel versions.
Storage Temperature	• -40 °C to +85 °C
Operating Altitude	• 3000 m with no derating

EMC & Safety

Emissions	• LP models P3-P5: EN55022, level B conducted LP-MD models, M3-M5: EN55011, level A conducted with FE(x) cover, level B conducted with ME(x) cover
ESD Immunity	• EN61000-4-2, level 3 Perf Criteria A
Radiated Immunity	• EN61000-4-3, level 3 Perf Criteria A
EFT/Burst	• EN61000-4-4, level 3 Perf Criteria A
Surge	• EN61000-4-5, level 3 Perf Criteria A
Conducted Immunity	• EN61000-4-6, level 3 Perf Criteria A
Dips & Interruptions	• EN61000-4-11, 30% 10 ms, 60% 100 ms, 100% 5000 ms, Criteria A, B, B
Safety Approvals	• LP models: EN60950, UL60950, CSA22.2 No 950, CE Mark LVD, SEMI F47 compliant (highline only) LP-MD models: EN60601-1, CSA22.2-601, UL60601-1, CE Mark LVD

Model Configuration



STEP 1

In order to configure a model number for your LP (industrial) or LP-MD (medical) series power supply, first select the appropriate chassis based on your application's continuous, maximum output power requirements. Select 'P' for industrial or 'M' for medical.

STEP 2

From the ratings below, select the output modules that suit your output voltage and current requirements. Modules can be positioned as denoted by the ■ and ▲ sequence shown below.

STEP 3

Form the model number as shown on the next page, ensuring you have selected a cooling method.

P3 & M3 (250 W) Model

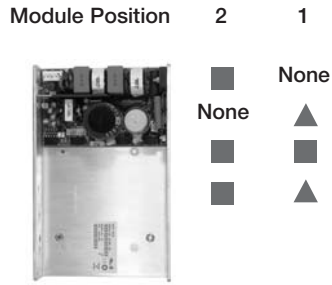

P4 & M4 (350 W) Model

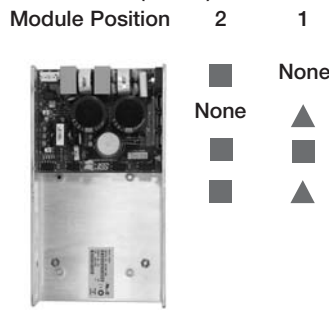

P5 & M5 (450 W) Model

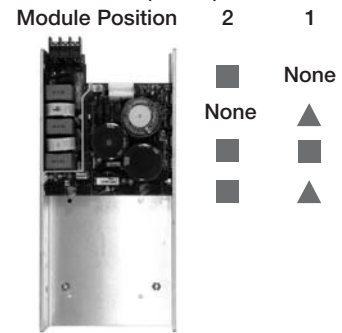

Output Modules Voltage (Adjustment) & Current Ratings

OUTPUT 1	OUTPUT 2	OUTPUT 3	MODULE CODE	MODULE SIZE
1.8 V (1.65-1.95 V) @ 50 A			SZ	■
2.5 V (2.25-2.75 V) @ 50 A			S1	■
3.3 V (3.25-3.50 V) @ 50 A			S2	■
5.0 V (4.50-5.50 V) @ 50 A			S3	■
8.0 V (7.20-8.80 V) @ 31 A			SF	■
10.0 V (9.00-11.00 V) @ 25 A			SG	■
12.0 V (11.00-13.00 V) @ 20 A			S4	■
15.0 V (14.00-16.00 V) @ 17 A			S5	■
24.0 V (21.00-26.00 V) @ 10 A			S6	■
28.0 V (25.00-31.00 V) @ 9 A			S7	■
36.0 V (32.00-40.00 V) @ 7 A			S8	■
48.0 V (43.00-53.00 V) @ 5 A			S9	■
3.3 V (3.25-3.50 V) @ 40 A	5.0 V (4.8-16.0 V) @ 4.0 A		U5	■
3.3 V (3.25-3.50 V) @ 40 A	12.0 V (4.8-16.0 V) @ 4.0 A		U6	■
3.3 V (3.25-3.50 V) @ 40 A	15.0 V (4.8-16.0 V) @ 4.0 A		U7	■
3.3 V (3.25-3.50 V) @ 40 A	24.0 V (19.0-28.0 V) @ 2.5 A		U8	■
5.0 V (4.80-5.20 V) @ 40 A	5.0 V (4.8-16.0 V) @ 4.0 A		U1	■
5.0 V (4.80-5.20 V) @ 40 A	12.0 V (4.8-16.0 V) @ 4.0 A		U2	■
5.0 V (4.80-5.20 V) @ 40 A	15.0 V (4.8-16.0 V) @ 4.0 A		U3	■
5.0 V (4.80-5.20 V) @ 40 A	24.0 V (19.0-28.0 V) @ 2.5 A		U4	■
5.0 V (4.80-5.20 V) @ 8 A	12.0 V (11.5-12.5 V) @ 6.0 A		R6 ⁽¹⁾	▲
5.0 V (4.80-5.20 V) @ 8 A	24.0 V (22.0-26.0 V) @ 3.0 A		R4 ⁽¹⁾	▲
12.0 V (11.50-12.50 V) @ 6 A	12.0 V (11.5-12.5 V) @ 6.0 A		R1 ⁽¹⁾	▲
12.0 V (11.50-12.50 V) @ 6 A	24.0 V (22.0-26.0 V) @ 3.0 A		R5 ⁽¹⁾	▲
15.0 V (14.00-16.00 V) @ 5 A	15.0 V (14.0-16.0 V) @ 5.0 A		R2 ⁽¹⁾	▲
3.3 V (3.25-3.50 V) @ 20 A	12.0 V (4.8-16.0 V) @ 4.0 A	12.0 V (4.8-16.0 V) @ 4 A	T3	▲
3.3 V (3.25-3.50 V) @ 20 A	15.0 V (4.8-16.0 V) @ 3.0 A	15.0 V (4.8-16.0 V) @ 3 A	T4	▲
5.0 V (4.80-5.20 V) @ 20 A	12.0 V (4.8-16.0 V) @ 4.0 A	12.0 V (4.8-16.0 V) @ 4 A	T1	▲
5.0 V (4.80-5.20 V) @ 20 A	15.0 V (4.8-16.0 V) @ 3.0 A	15.0 V (4.8-16.0 V) @ 3 A	T2	▲
5.0 V (4.80-5.20 V) @ 20 A	12.0 V (4.8-16.0 V) @ 4.0 A	5.0 V (4.8-16.0 V) @ 4 A	T8	▲
12.0 V (11.50-12.50 V) @ 10 A	12.0 V (4.8-16.0 V) @ 4.0 A	5.0 V (4.8-16.0 V) @ 4 A	T6	▲
12.0 V (11.50-12.50 V) @ 10 A	12.0 V (4.8-16.0 V) @ 4.0 A	15.0 V (4.8-16.0 V) @ 3 A	T10	▲
24.0 V (22.00-26.00 V) @ 4 A	5.0 V (4.8-16.0 V) @ 4.0 A	5.0 V (4.8-16.0 V) @ 4 A	T11	▲
24.0 V (22.00-26.00 V) @ 4 A	15.0 V (4.8-16.0 V) @ 4.0 A	5.0 V (4.8-16.0 V) @ 4 A	T9	▲
24.0 V (22.00-26.00 V) @ 4 A	15.0 V (4.8-16.0 V) @ 3.0 A	15.0 V (4.8-16.0 V) @ 3 A	T7	▲

1. R modules do not have signals or control facilities.
 2. Output V2 & V3 of U & T modules can supply up to 5 A in certain applications dependent on other rail loadings. Contact sales for details.
 3. Also available from Farnell and Newark.



Preconfigured Models - Industrial

Output Power Max	Output 1	Output 2	Output 3	Output 4	Industrial Version Model Number
250 W	5.0 V @ 50 A				P3S3FE3
	12.0 V @ 20 A				P3S4FE3
	24.0 V @ 10 A				P3S6FE3
	48.0 V @ 5 A				P3S9FE3
350 W	5.0 V @ 50 A	5.0 V @ 50 A			P4S3S3FE4
	12.0 V @ 20 A	12.0 V @ 20 A			P4S4S4FE4
	5.0 V @ 50 A	3.3 V @ 40 A	12.0 V (4.8-16.0 V) @ 4 A		P4S3U6FE4
	5.0 V @ 50 A	12.0 V @ 10 A	12.0 V (4.8-16.0 V) @ 4 A	5.0 V (4.8-16.0 V) @ 4.0 A	P4S3T6FE4
450 W	12.0 V @ 20 A	12.0 V @ 20 A			P5S4S4FE5
	5.0 V @ 50 A	3.3 V @ 40 A	12.0 V (4.8-16.0 V) @ 4 A		P5S3U6FE5
	5.0 V @ 50 A	12.0 V @ 10 A	12.0 V (4.8-16.0 V) @ 4 A	5.0 V (4.8-16.0 V) @ 4.0 A	P5S3T6FE5
	3.3 V @ 40 A	5.0 V @ 40 A	12.0 V (4.8-16.0 V) @ 4 A	24.0 V (19.0-28.0 V) @ 2.5 A	P5U4U6FE5

Model Number Example - Industrial (P) Versions

Chassis Power	Module Position 2	Module Position 1	Fan Assembly Style	Parallel Option
P3	S3	T1	FE3	01

Choose the chassis code first:

P3 = 250 W Chassis
 P4 = 350 W Chassis
 P5 = 450 W Chassis

Add any ▲ or ■ module

e.g. S3 = Single 5 V

Add any ▲ or ■ module

e.g. T1 = Triple 5 V/12 V/12 V

Add fan cover assembly.

e.g. FE3 = End fan assembly for 250 W chassis

Leave blank for open U-channel

Add parallel option if required

2 x S module 1.8-15 V = 01
 2 x S module 24-48 V = 02

Leave blank if not required



P3 Model



■



▲



FE(x) End Fan
 Screw terminal AC connections

NOTE:
 Model number format and module position may change dependent on module configuration chosen.
 Connector kits available. Order part number LP CONN KIT.

Fan Assemblies

Alternative fan assemblies are available. Consult sales for details.

FTx Top Fan. Molex header AC connections



End Fan. IEC AC connections



Preconfigured Models - Medical

LP-MD XP

Output Power Max	Output 1	Output 2	Output 3	Output 4	Medical Version Model Number
250 W	5.0 V @ 50 A				M3S3ME3
	12.0 V @ 20 A				M3S4ME3
	24.0 V @ 10 A				M3S6ME3
	48.0 V @ 5 A				M3S9ME3
350 W	5.0 V @ 50 A	5.0 V @ 50 A			M4S3S3ME4
	12.0 V @ 20 A	12.0 V @ 20 A			M4S4S4ME4
	5.0 V @ 50 A	3.3 V @ 40 A	12.0 V (4.8-16.0 V) @ 4 A		M4S3U6ME4
	5.0 V @ 50 A	12.0 V @ 10 A	12.0 V (4.8-16.0 V) @ 4 A	5.0 V (4.8-16.0 V) @ 4.0 A	M4S3T6ME4
450 W	12.0 V @ 20 A	12.0 V @ 20 A			M5S4S4ME5
	5.0 V @ 50 A	3.3 V @ 40 A	12.0 V (4.8-16.0 V) @ 4 A		M5S3U6ME5
	5.0 V @ 50 A	12.0 V @ 10 A	12.0 V (4.8-16.0 V) @ 4 A	5.0 V (4.8-16.0 V) @ 4.0 A	M5S3T6ME5
	3.3 V @ 40 A	5.0 V @ 40 A	12.0 V (4.8-16.0 V) @ 4 A	24.0 V (19.0-28.0 V) @ 2.5 A	M5U4U6ME5

Notes

- Medical versions shown include EMC class B fan assembly.

Model Number Example - Medical (M) Versions

Chassis Power	Module Position 2	Module Position 1	Fan Assembly Style	Parallel Option
M3	S3	T1	ME3	01

Choose the chassis code first:

M3 = 250 W Chassis
M4 = 350 W Chassis
M5 = 450 W Chassis

Add any ▲ or ■ module

e.g. S3 = Single 5 V

Add any ▲ or ■ module

e.g. T1 = Triple 5 V/12 V/12 V

Add fan cover assembly.

e.g. ME3 = End fan assembly for 250 W chassis

Leave blank for open U-channel

Add parallel option if required

2 x S module 1.8-15 V = 01
2 x S module 24-48 V = 02

Leave blank if not required



M3 Model



ME(x) End Fan

Screw terminal AC connections Class B



FE(x) End Fan

Screw terminal AC connections Class A

NOTE:

Model number format and module position may change dependent on module configuration chosen.
Connector kits available. Order part number LP CONN KIT.

Fan Assemblies

End Fan. IEC Dual-fused and switched AC connections. Class B



End Fan. IEC AC connections. Class A



Top Fan. Molex header AC connections



Alternative fan assemblies are available. Consult sales for details.



T H E X P E R T S I N P O W E R

AC OK/Power Fail

When fitted in module position 2 of the chassis, pins 10 and 2 provide a minimum of 5 ms warning of loss of output regulation.

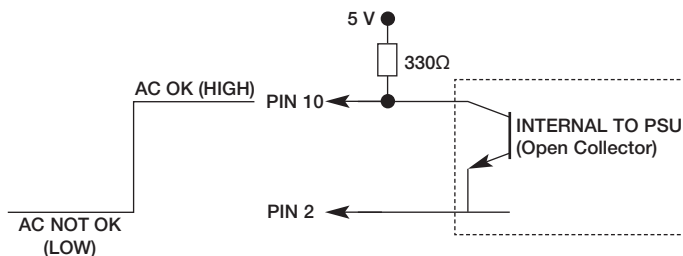

Current Share

Connecting pins 4 & 2 of like part number modules (3 maximum) within the same chassis or separate chassis will force the modules to current share the outputs.

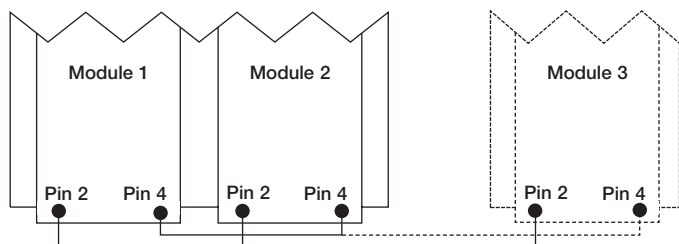

DC OK

Pins 8 and 2 provide notification that the output voltage is within regulation via a logic 1.

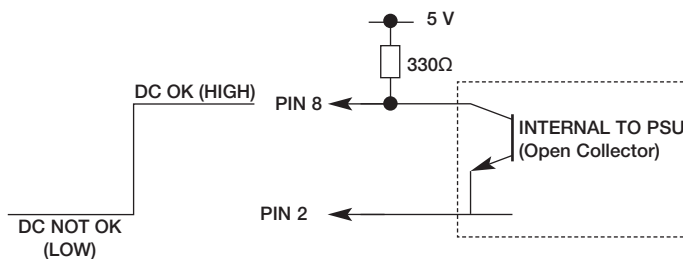

(Reverse logic option available, i.e. high for DC NOT OK).

Notes

- 1. (R) module does not have these signal facilities.

Global Inhibit

Inhibiting the module fitted in position 2 will inhibit all outputs of other modules (fans remain running if fitted). If individual inhibit is required on the module fitted in chassis position 2 alternative configurations are available. Please consult our application engineering team.

Inhibit

Pins 6 and 2 (return) provide on/off control of the module. Applying a logic '0' between these pins turns the outputs off.

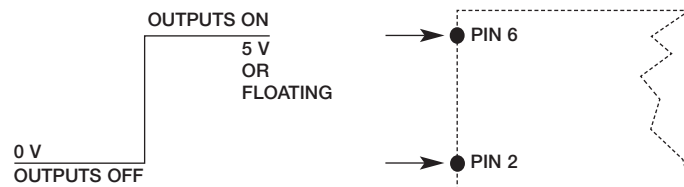

(Reverse logic option available, i.e. high for outputs off or low for outputs on).

Modules in Parallel

Single output modules with the same part number and V1 of dual and triple output modules can be paralleled to obtain increased output current. These modules can either be fitted in the same chassis or a different chassis with their outputs connected directly together and current share connections made, see *Current Share*.

Modules in Series

Single output modules can be connected in series to obtain alternate output voltages not available from a single module. For example a 10 V (SG module) can be connected in series with a 12 V (S4 module) to obtain an output voltage of 22 V.

Remote Sense

Pins 1 (+ve) and 2 (-ve) provide compensation for voltage drops in application wiring up to a maximum of 0.5 V. Remote Sense is not fitted to (R) modules and V2 & V3 of (U) and (T) modules.

Housekeeping

A 5 V standby voltage rated at 1 A is fitted to each chassis.

Mechanical Details 250 Watt P3 & M3 Models U Channel

LP & LP-MD XP

Weight: 1.40 lb (0.64 kg) approx

See Airflow Curves

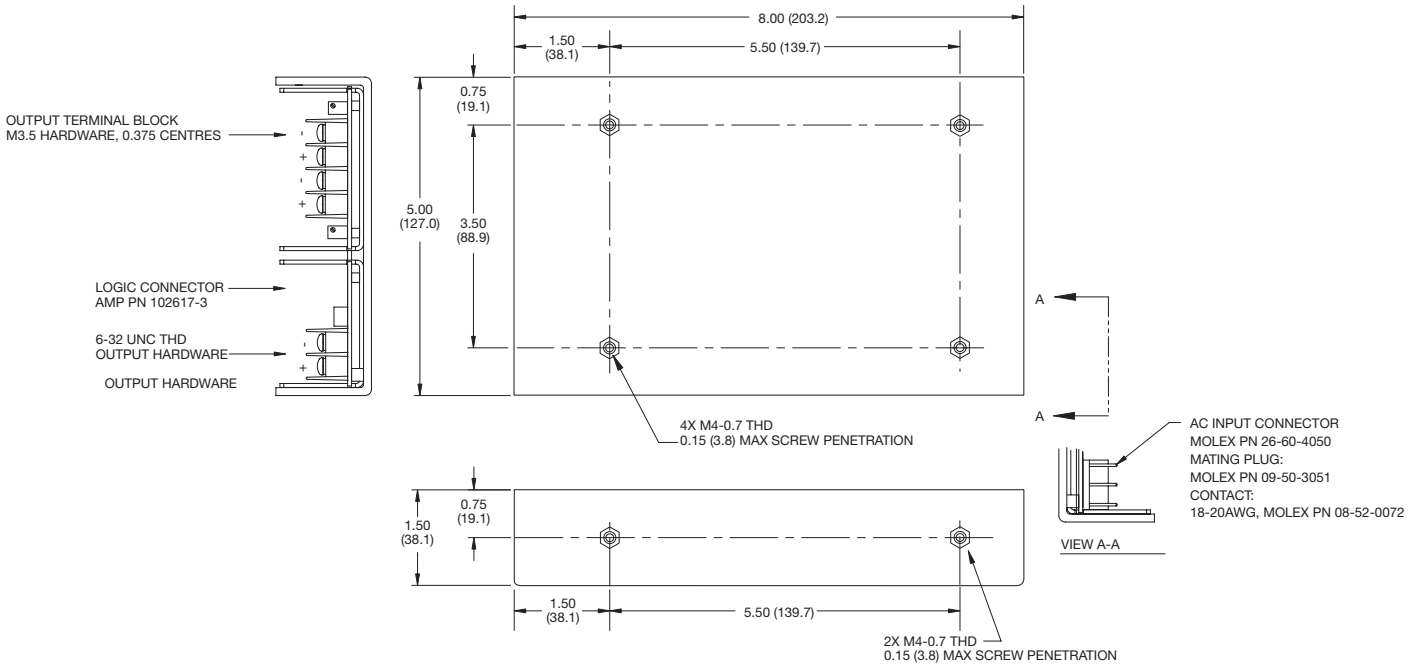

FE3 Fan Assembly

Weight: 1.90 lb (0.86 kg) approx

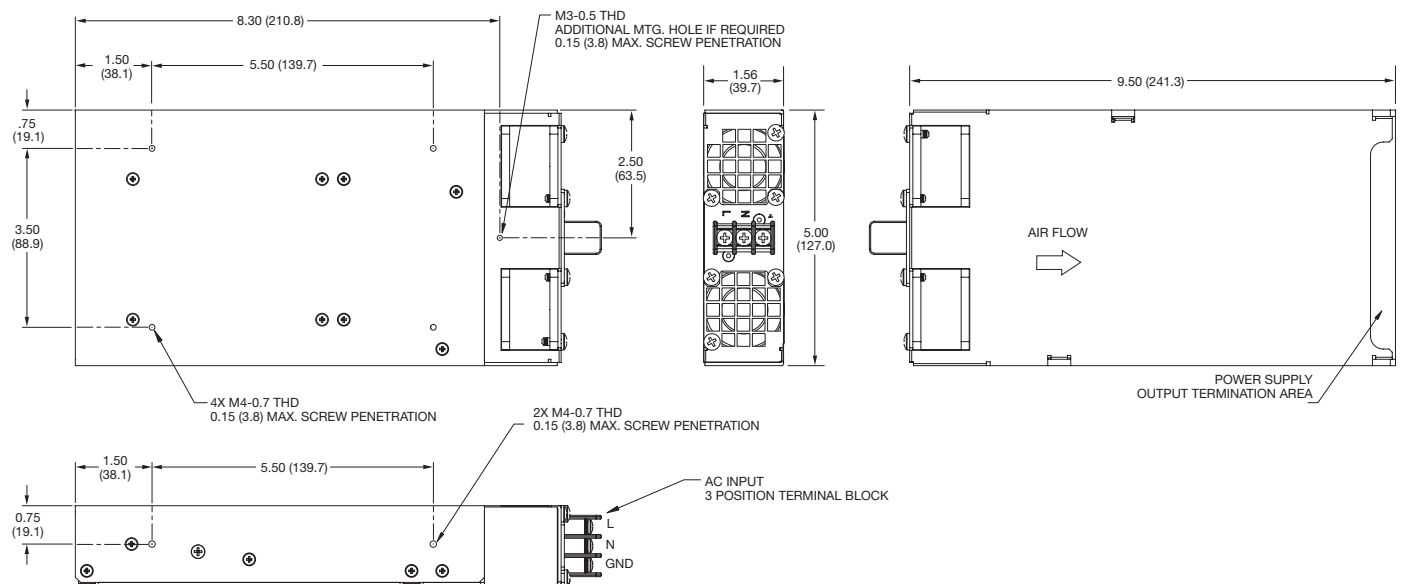

Notes

1. Supplies are SEMI F47 at highline input (180-264) at 100% rated output power. Certification details available on request.
2. Mating connector kit available. Order part number LP CONN KIT.
3. Dimensions in inches (mm).



Mechanical Details 350 Watt P4 & M4 Models

U-Channel

See Airflow Curves

Weight: 1.50 lb (0.68 kg) approx

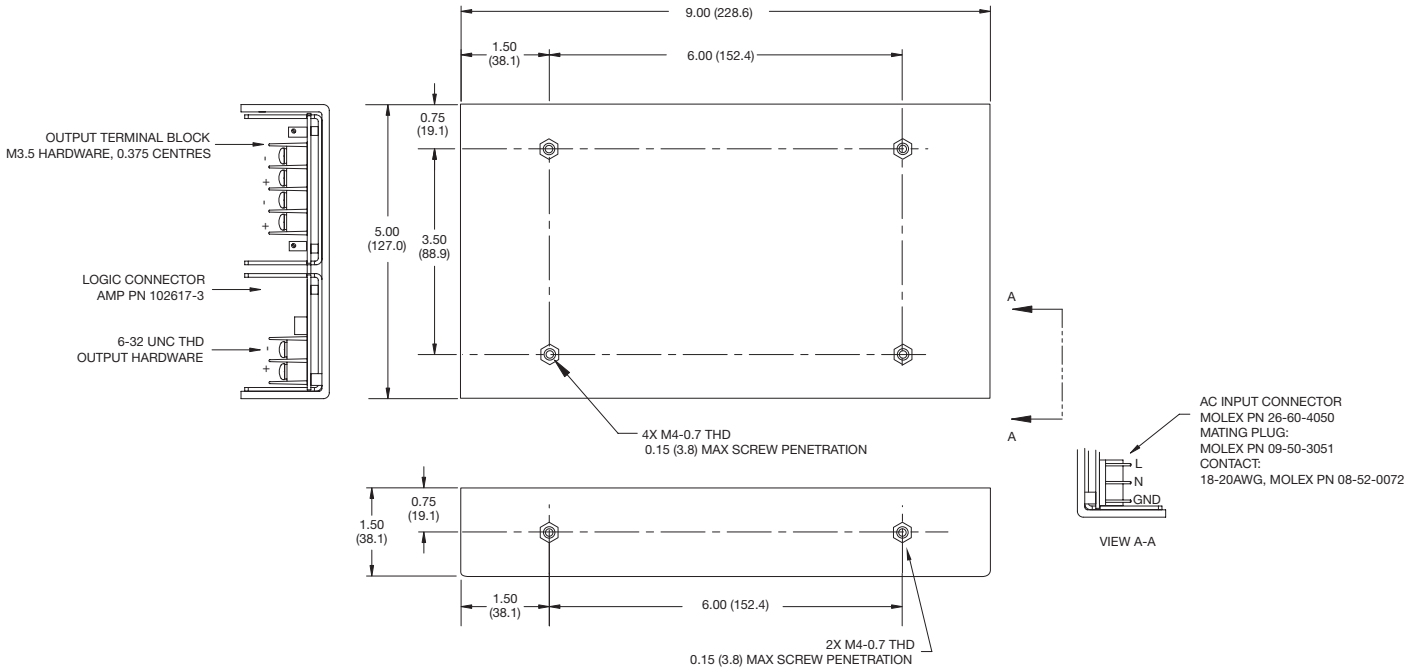

FE4 Fan Assembly

Weight: 2.00 lb (0.91 kg) approx

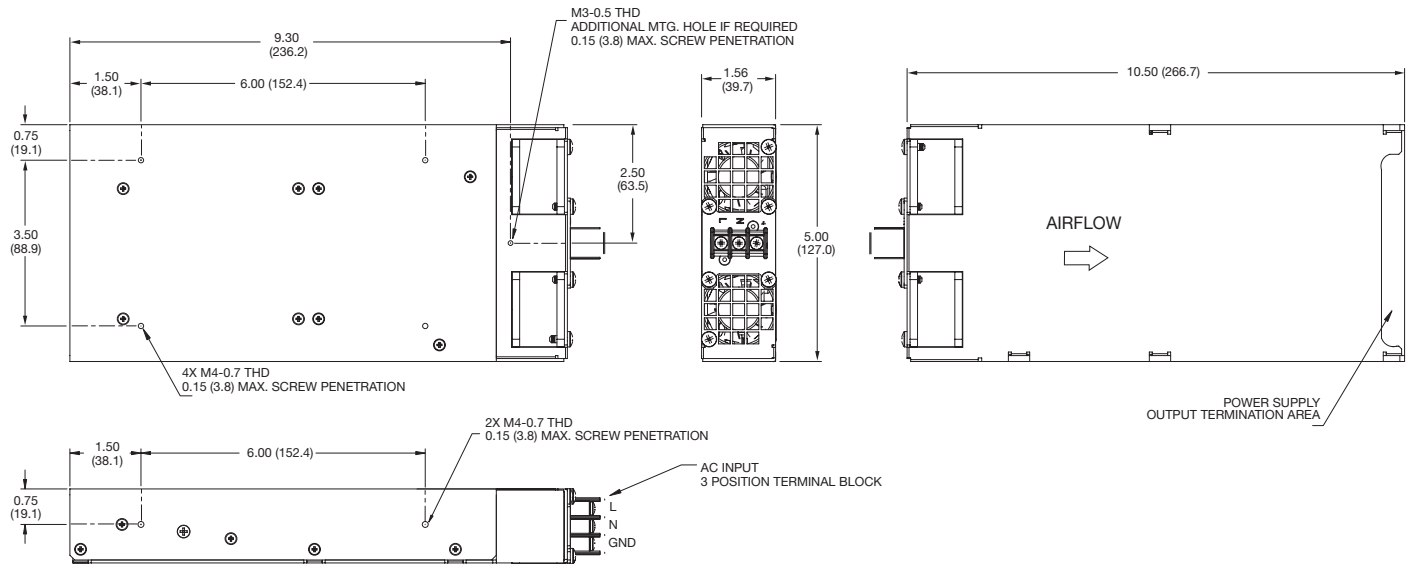

Notes

1. Supplies are SEMI F47 at highline input (180-264) at 100% rated output power. Certification details available on request.
2. Mating connector kit available. Order part number LP CONN KIT.
3. Dimensions in inches (mm).

Mechanical Details 250/350 Watt M3 & M4 ME3 Fan Assembly (M Models Only)

Weight: 2.00 lb (0.91 kg) approx

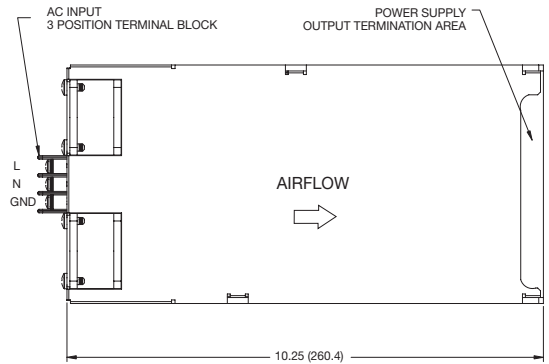
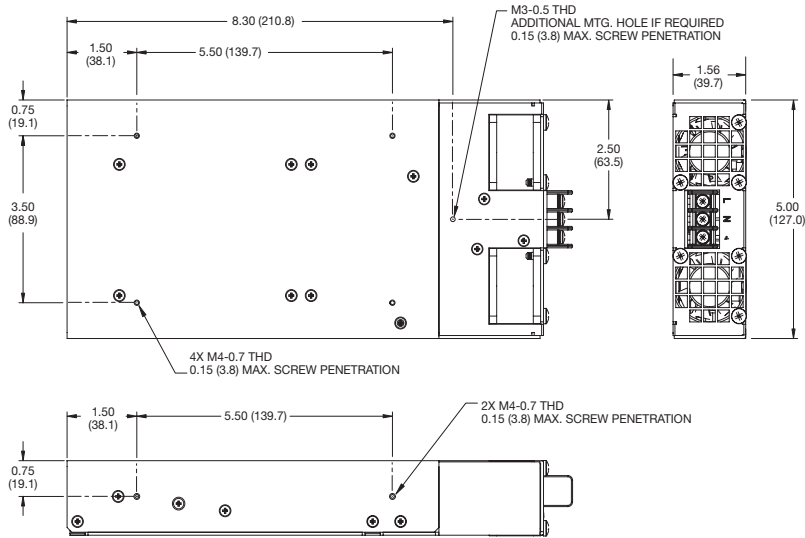

ME4 Fan Assembly (M Models Only)

Weight: 2.16 lb (0.98 kg) approx

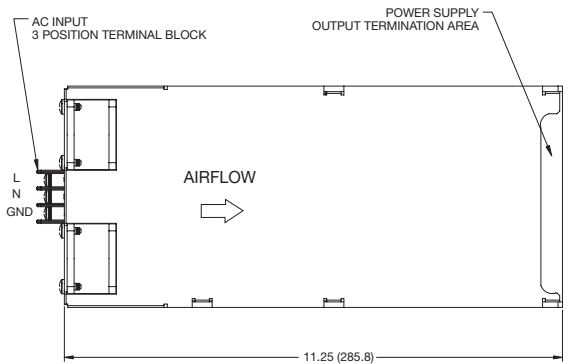
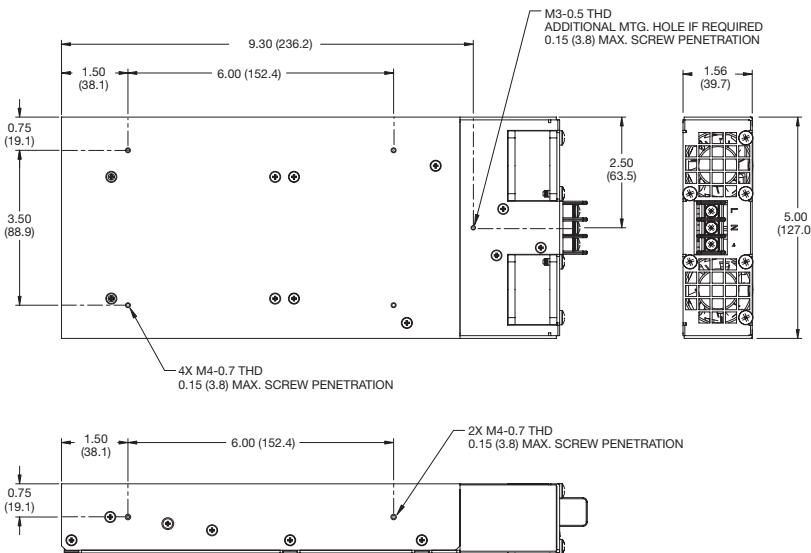

Notes

1. Supplies are SEMI F47 at highline input (180-264) at 100% rated output power. Certification details available on request.
2. Mating connector kit available. Order part number LP CONN KIT.
3. Dimensions in inches (mm).

Mechanical Details 450 Watt P5 & M5 Models

450 Watts - P5 and M5 models are always shipped with a fan cover to ensure adequate cooling.

FE5 Fan Assembly

Weight: 2.50 lb (1.14 kg) approx

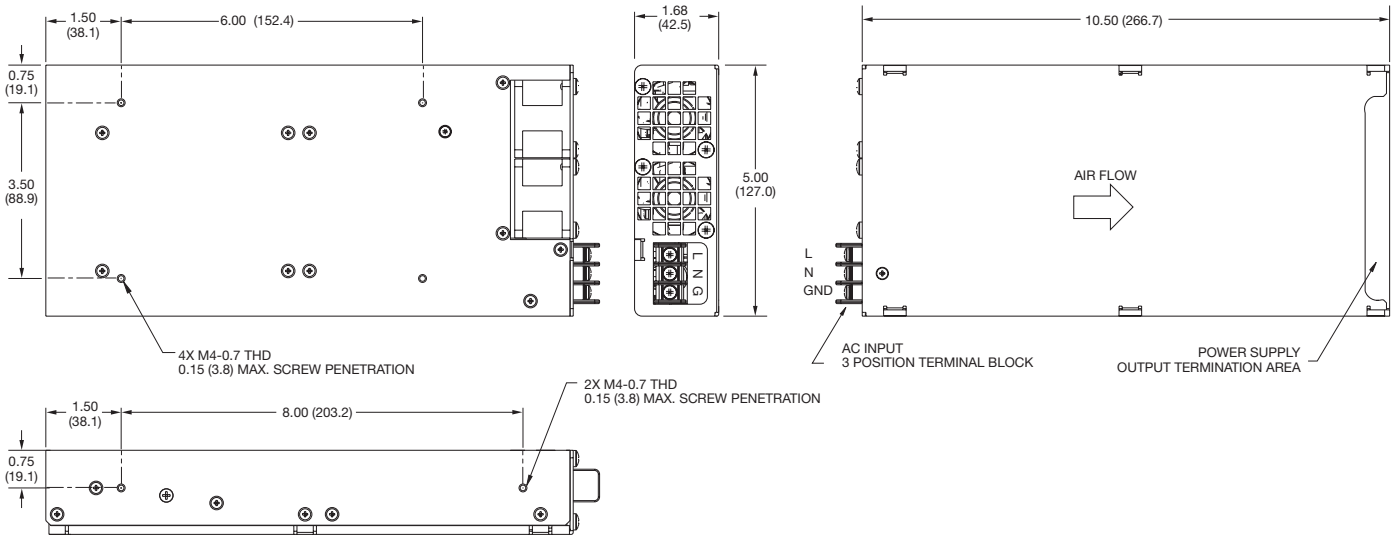

ME5 Fan Assembly (M Models Only)

Weight: 2.62 lb (1.19 kg) approx

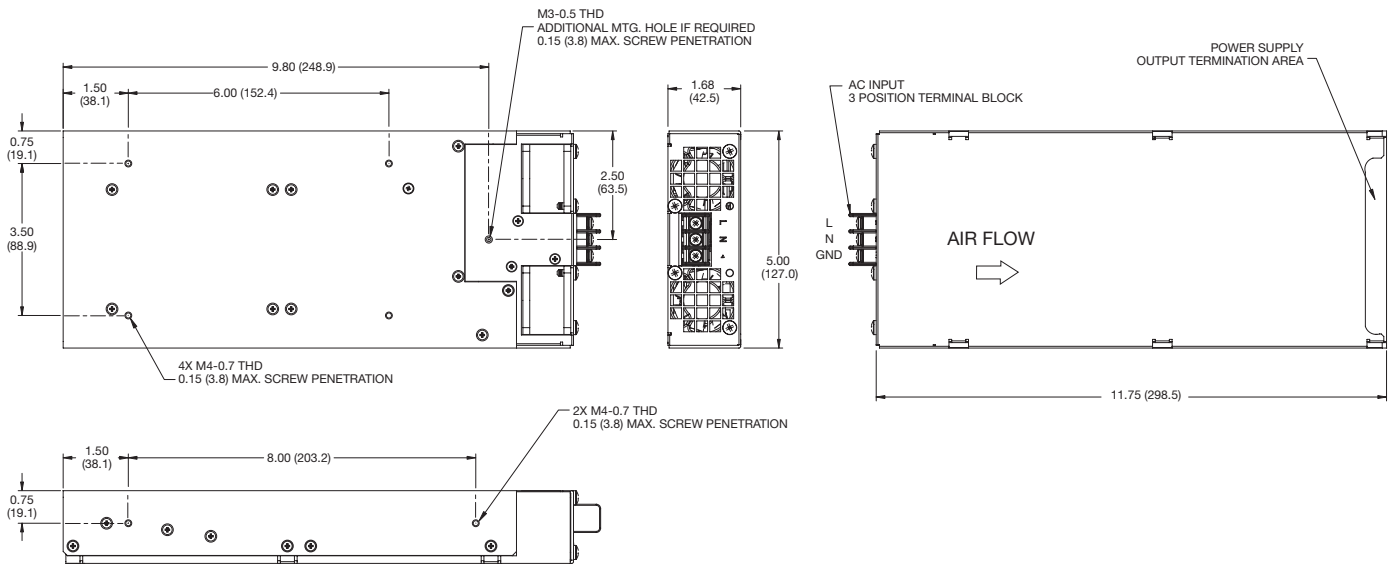

Notes

1. Supplies are SEMI F47 at highline input (180-264) at 100% rated output power. Certification details available on request.
2. Mating connector kit available. Order part number LP CONN KIT.
3. Dimensions in inches (mm).

Airflow Curves - U-Channel Models

The curves denote chassis derating. Output modules must be derated by the same proportion.

Formula for converting CFM to LFM:

$$LFM = \frac{CFM \times 144}{(\text{total cross section of airflow path (Inches}^2\text{)})}$$

Formula for converting LFM to CFM:

$$CFM = \frac{LFM \times (\text{total cross section of airflow path (Inches}^2\text{)})}{144}$$

P3 & M3 Models

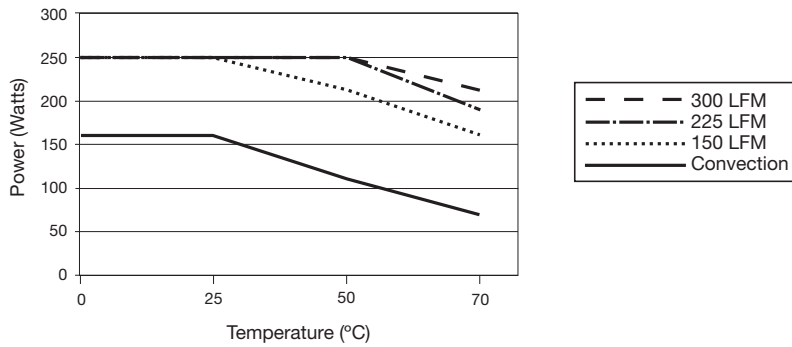

P4 & M4 Models

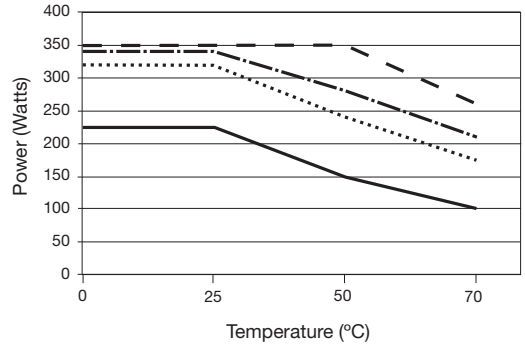

Output Module Connection Details

Single Output (S)

Weight: 0.50 lb (227 g) approx

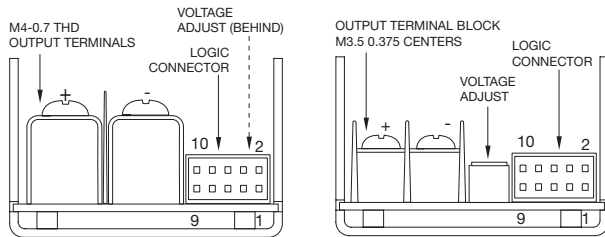

Logic Connector AMP 87631-5	
Pin	Function
1	+sense (V1)
2	-sense (V1)
3	+sense (V1)
4	Current share
5	
6	Inhibit
7	-sense (V1)
8	DC OK
9	
10	Power fail

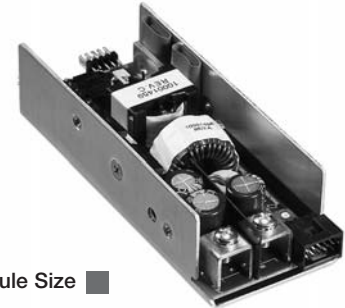

Module Size ▀

Dual Output (R)

Weight: 0.52 lb (236 g) approx

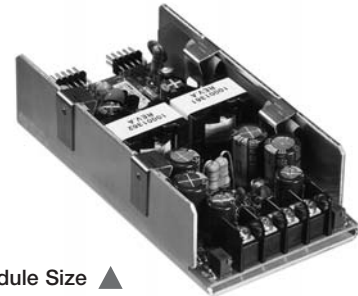
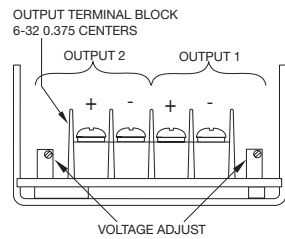

Module Size ▲

Dual Output (U)

Weight: 0.62 lb (282 g) approx

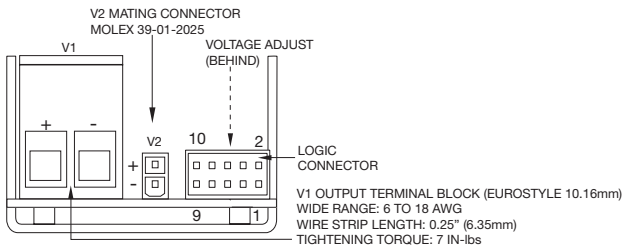

Logic Connector AMP 87631-5	
Pin	Function
1	+sense (V1)
2	-sense (V1)
3	+sense (V1)
4	Current share
5	
6	Inhibit
7	-sense (V1)
8	DC OK
9	
10	Power fail

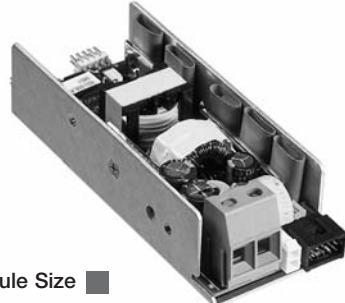

Module Size ▀

Triple Output (T)

Weight: 0.70 lb (318 g) approx

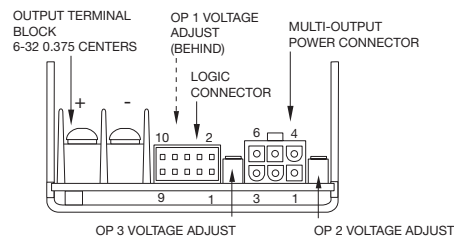

Output Connector Molex 39-01-2060	
Pin	Function
1	Output RTN V2
2	
3	Output RTN V3
4	Output 2+
5	
6	Output 3+

Logic Connector AMP 87631-5	
Pin	Function
1	+sense (V1)
2	-sense (V1)
3	+sense (V1)
4	Current share
5	
6	Inhibit
7	-sense (V1)
8	DC OK
9	
10	Power fail

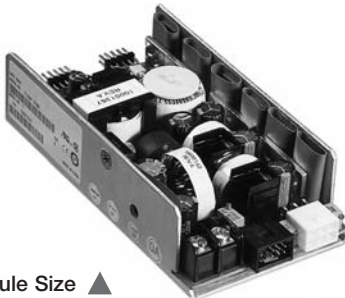

Module Size ▲