

## Hyper Mini TOPLED® RG Hyper-Bright LED

LS M776, LA M776, LO M776  
LY M776

### Besondere Merkmale

- Gehäusefarbe: weiß
- als optischer Indikator einsetzbar
- zur Hinterleuchtung, Lichtleiter- und Linseneinkopplung
- für alle SMT-Bestück- und Löttechniken geeignet
- gegurtet (8-mm-Filmgurt)

### Features

- color of package: white
- for use as optical indicator
- for backlighting, optical coupling into light pipes and lenses
- suitable for all SMT assembly and soldering methods
- available taped on reel (8 mm tape)

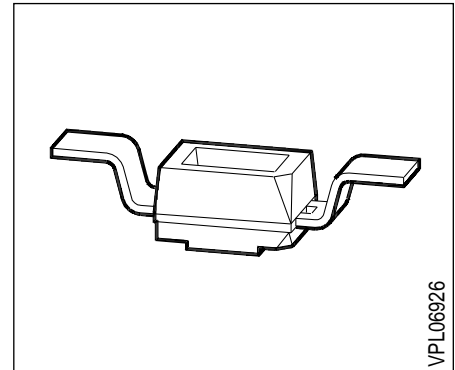

Typ Type	Emissions- farbe Color of Emission	Farbe der Licht- austrittsfläche Color of the Light Emitting Area	Lichtstärke Luminous Intensity $I_F = 20 \text{ mA}$ $I_V \text{ (mcd)}$	Lichtstrom Luminous Flux $I_F = 20 \text{ mA}$ $\Phi_V \text{ (lm)}$	Bestellnummer Ordering Code
LS M776-MQ LS M776-N LS M776-P LS M776-Q LS M776-NR	super-red	colorless clear	16 ... 125 25 ... 50 40 ... 80 63 ... 125 25 ... 200	- 100 (typ.) 180 (typ.) 300 (typ.) -	Q62703-Q3859 Q62703-Q3860 Q62703-Q3861 Q62703-Q3862 Q62703-Q3863
LA M776-NR LA M776-P LA M776-Q LA M776-R LA M776-PS	amber	colorless clear	25 ... 200 40 ... 80 63 ... 125 100 ... 200 40 ... 320	- 180 (typ.) 300 (typ.) 450 (typ.) -	Q62703-Q3864 Q62703-Q3865 Q62703-Q3866 Q62703-Q3867 Q62703-Q3868
LO M776-NR LO M776-P LO M776-Q LO M776-R LO M776-PS	orange	colorless clear	25 ... 200 40 ... 80 63 ... 125 100 ... 200 40 ... 320	- 180 (typ.) 300 (typ.) 450 (typ.) -	Q62703-Q3869 Q62703-Q3870 Q62703-Q3871 Q62703-Q3872 Q62703-Q3873
LY M776-NR LY M776-P LY M776-Q LY M776-R LY M776-PS	yellow	colorless clear	25 ... 200 40 ... 80 63 ... 125 100 ... 200 40 ... 320	- 180 (typ.) 300 (typ.) 450 (typ.) -	Q62703-Q3874 Q62703-Q3875 Q62703-Q3876 Q62703-Q3877 Q62703-Q3878

Streuung der Lichtstärke in einer Verpackungseinheit  $I_{V \max} / I_{V \min} \leq 2.0$ .

Luminous intensity ratio in one packaging unit  $I_{V \max} / I_{V \min} \leq 2.0$ .

## Grenzwerte Maximum Ratings

Bezeichnung Parameter	Symbol Symbol	Werte Values		Einheit Unit
		LS, LO, LA	LY	
Betriebstemperatur Operating temperature range	$T_{op}$	– 55 ... + 100		°C
Lagertemperatur Storage temperature range	$T_{stg}$	– 55 ... + 100		°C
Sperrschichttemperatur Junction temperature	$T_j$	+ 100		°C
Durchlaßstrom Forward current	$I_F$	30	20	mA
Stoßstrom Surge current $t \leq 10 \mu s, D = 0.005$	$I_{FM}$	to be defined		A
Sperrspannung <sup>1)</sup> Reverse voltage <sup>1)</sup>	$V_R$	3		V
Verlustleistung Power dissipation	$P_{tot}$	80 <sup>2)</sup>	55 <sup>2)</sup>	mW
Wärmewiderstand Thermal resistance Sperrschicht / Umgebung Junction / air Montage auf PC-board*) (Padgröße $\geq 16 \text{ mm}^2$ ) mounted on PC board*) (pad size $\geq 16 \text{ mm}^2$ )	$R_{th JA}$	630 <sup>2)</sup>	500	K/W

1) Belastung in Sperrichtung sollte vermieden werden.

1) Reverse biasing should be avoided.

2) vorläufig/preliminary

\*) PC-board: FR4

**Kennwerte** ( $T_A = 25\text{ °C}$ )

**Characteristics**

Bezeichnung Parameter	Symbol Symbol	Werte Values				Einheit Unit
		LS	LA	LO	LY	
Wellenlänge des emittierten Lichtes Wavelength at peak emission $I_F = 20\text{ mA}$	(typ.) $\lambda_{\text{peak}}$ (typ.)	645	622	610	591	nm
Dominantwellenlänge Dominant wavelength $I_F = 20\text{ mA}$	(typ.) $\lambda_{\text{dom}}$ (typ.)	632	615	605	587	nm
Spektrale Bandbreite bei 50% $I_{\text{rel max}}$ Spectral bandwidth at 50% $I_{\text{rel max}}$ $I_F = 20\text{ mA}$	(typ.) $\Delta\lambda$ (typ.)	16	16	16	15	nm
Abstrahlwinkel bei 50% $I_v$ (Vollwinkel) Viewing angle at 50% $I_v$	$2\phi$	120	120	120	120	Grad deg.
Durchlaßspannung Forward voltage $I_F = 20\text{ mA}$	(typ.) $V_F$ (max.) $V_F$	2.0 2.6	2.0 2.6	2.0 2.6	2.0 2.6	V V
Sperrstrom Reverse current $V_R = 3\text{ V}$	(typ.) $I_R$ (max.) $I_R$	0.01 10	0.01 10	0.01 10	0.01 10	$\mu\text{A}$ $\mu\text{A}$
Temperaturkoeffizient von $\lambda_{\text{dom}}$ ( $I_F = 20\text{ mA}$ ) Temperature coefficient of $\lambda_{\text{dom}}$ ( $I_F = 20\text{ mA}$ )	$TC_\lambda$	0.014	0.062	0.067	0.096	nm/K
Temperaturkoeffizient von $\lambda_{\text{peak}}$ , $I_F = 20\text{ mA}$ Temperature coefficient of $\lambda_{\text{peak}}$ , $I_F = 20\text{ mA}$	(typ.) $TC_\lambda$ (typ.)	0.14	0.13	0.13	0.13	nm/K
Temperaturkoeffizient von $V_F$ , $I_F = 20\text{ mA}$ (typ.) Temperature coefficient of $V_F$ , $I_F = 20\text{ mA}$ (typ.)	$TC_V$	- 1.95	- 1.78	- 1.67	- 2.51	mV/K

Relative spektrale Emission  $I_{rel} = f(\lambda)$ ,  $T_A = 25\text{ }^\circ\text{C}$ ,  $I_F = 10\text{ mA}$

Relative spectral emission

$V(\lambda)$  = spektrale Augenempfindlichkeit

Standard eye response curve

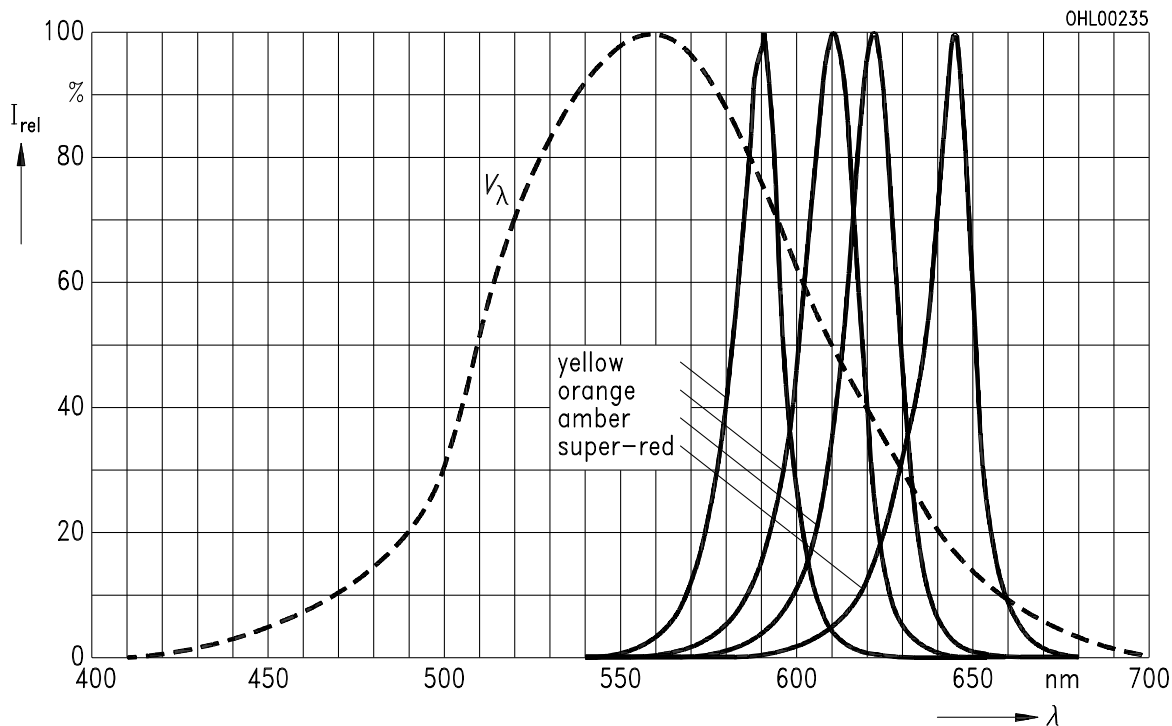

Abstrahlcharakteristik  $I_{rel} = f(\varphi)$

Radiation characteristic

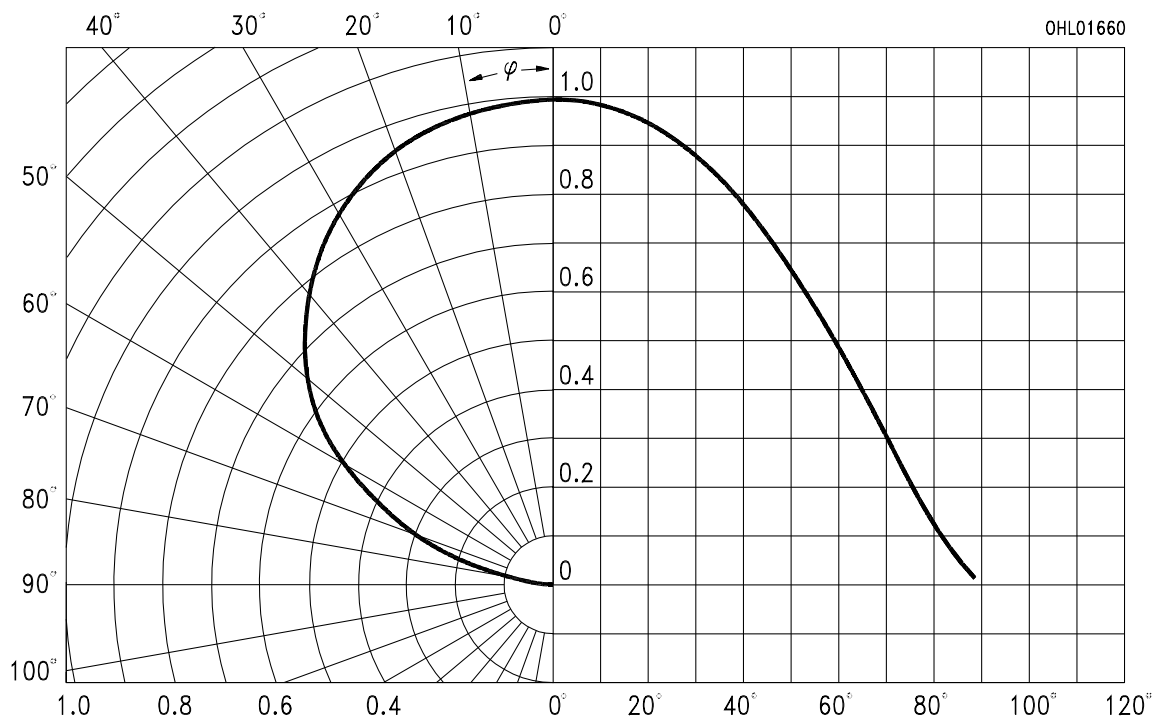

### Durchlaßstrom $I_F = f(V_F)$

#### Forward current

$T_A = 25^\circ\text{C}$

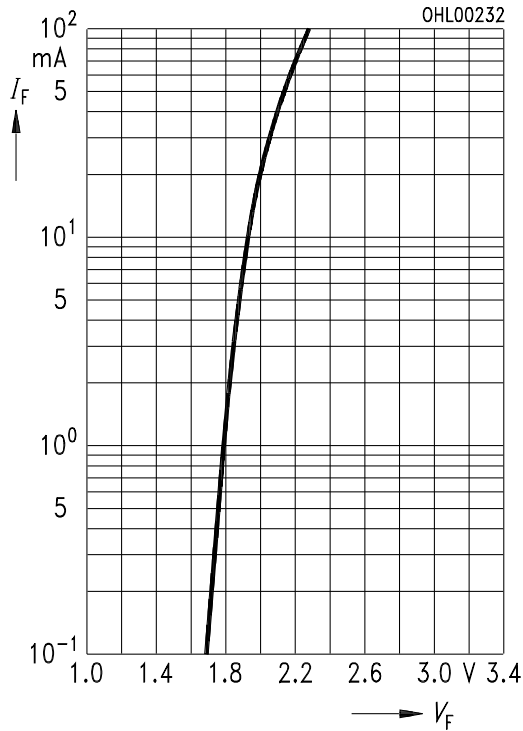

### Relative Lichtstärke $I_V / I_{V(20\text{mA})} = f(I_F)$

#### Relative luminous intensity

$T_A = 25^\circ\text{C}$

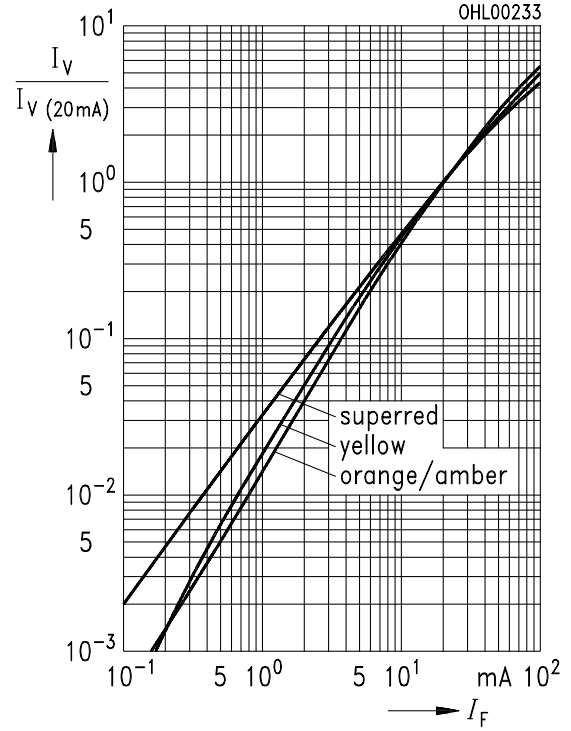

### Maximal zulässiger Durchlaßstrom

#### Max. permissible forward current

$I_F = f(T_A)$

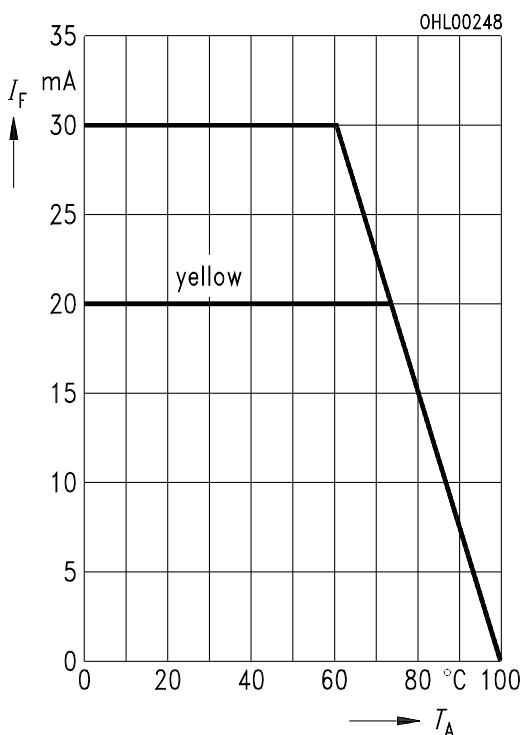

### Relative Lichtstärke $I_V / I_{V(25^\circ\text{C})} = f(T_A)$

#### Relative luminous intensity

$I_F = 10\text{ mA}$

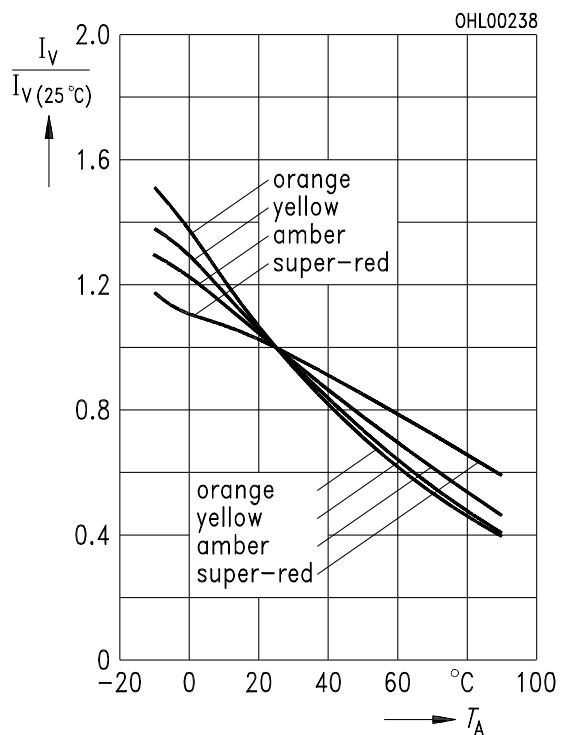

**Zulässige Impulsbelastbarkeit  $I_F = f(t_p)$**   
**Permissible pulse handling capability**  
**LS, LA, LO**

Duty cycle  $D =$  parameter,  $T_A = 25\text{ °C}$

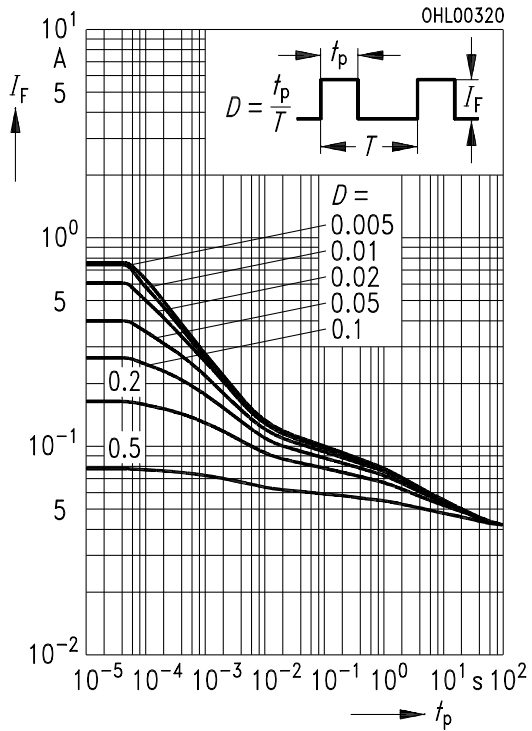

**Zulässige Impulsbelastbarkeit  $I_F = f(t_p)$**   
**Permissible pulse handling capability**  
**LY**

Duty cycle  $D =$  parameter,  $T_A = 25\text{ °C}$

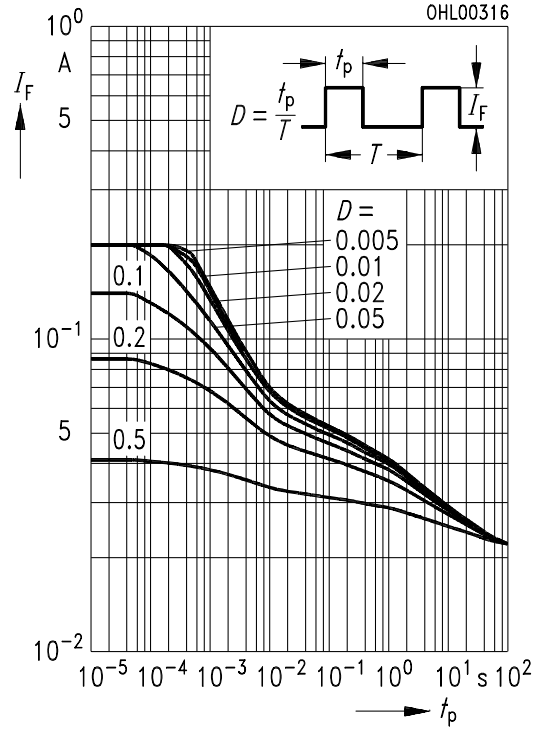

**Maßzeichnung** (Maße in mm, wenn nicht anders angegeben)  
**Package Outlines** (Dimensions in mm, unless otherwise specified)

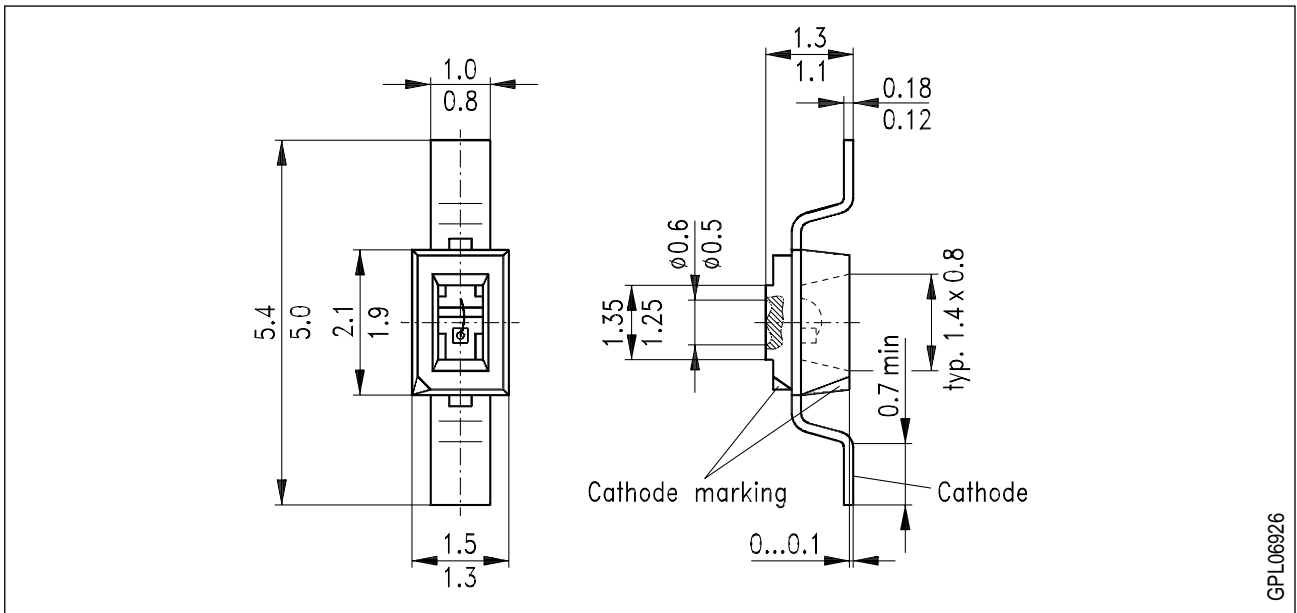

GPL06926

**Kathodenkennung:** abgeschrägte Ecke  
**Cathode mark:** bevelled edge