

AT-32063

Low Current, High Performance NPN Silicon Bipolar Transistor



Data Sheet



Lead (Pb) Free
RoHS 6 fully
compliant



Description

The AT-32063 contains two high performance NPN bipolar transistors in a single SOT-363 package. The devices are unconnected, allowing flexibility in design. The pin-out is convenient for cascode amplifier designs. The SOT-363 package is an industry standard plastic surface mount package.

The 3.2 micron emitter-to-emitter pitch and reduced parasitic design of the transistor yields extremely high performance products that can perform a multiplicity of tasks. The 20 emitter finger interdigitated geometry yields a transistor that is easy to match to and extremely fast, with moderate power, low noise resistance, and low operating currents.

Optimized performance at 2.7 V makes this device ideal for use in 900 MHz, 1.8 GHz, and 2.4 GHz battery operated systems as an LNA, gain stage, buffer, oscillator, or active mixer. Typical amplifier designs at 900 MHz yield 1.3 dB noise figures with 12 dB or more associated gain at a 2.7 V, 5 mA bias, with noise performance being relatively insensitive to input match. High gain capability at 1 V, 1 mA makes this device a good fit for 900 MHz pager applications. Voltage breakdowns are high enough for use at 5 volts.

The AT-3 series bipolar transistors are fabricated using an optimized version of Avago's 10 GHz f_t , 30 GHz f_{max} Self-Aligned-Transistor (SAT) process. The die are nitride passivated for surface protection. Excellent device uniformity, performance and reliability are produced by the use of ion-implantation, self-alignment techniques, and gold metallization in the fabrication of these devices.

Features

- High Performance Bipolar Transistor Optimized for Low Current, Low Voltage Operation
- 900 MHz Performance: 1.1 dB NF, 14.5 dB G_A
- Characterized for End-of-Life Battery Use (2.7 V)
- SOT-363 (SC-70) Plastic Package
- Tape-and-Reel Packaging Option Available
- Lead-free

Surface Mount Package SOT-363 (SC-70)

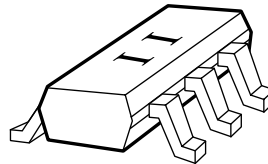

Pin Connections and Package Marking

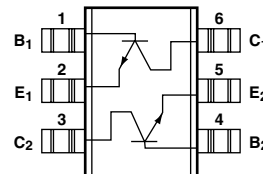

AT-32063 Absolute Maximum Ratings^[1]

Symbol	Parameter	Units	Absolute Maximum
V_{EBO}	Emitter-Base Voltage	V	1.5
V_{CBO}	Collector-Base Voltage	V	11
V_{CEO}	Collector-Emitter Voltage	V	5.5
I_C	Collector Current	mA	32
P_T	Power Dissipation ^[2,3]	mW	150
T_J	Junction Temperature	°C	150
T_{STG}	Storage Temperature	°C	-65 to 150

Thermal Resistance^[2]:

$$\theta_{jc} = 370^\circ\text{C/W}$$

Notes:

1. Permanent damage may occur if any of these limits are exceeded.
2. $T_{\text{Mounting Surface}} = 25^\circ\text{C}$.
3. Derate at 2.7 mW/°C for $T_C > 94.5^\circ\text{C}$.
4. 150 mW per device.

Electrical Specifications, $T_A = 25^\circ\text{C}$

Symbol	Parameters and Test Conditions	Units	Min.	Typ.	Max.
NF	Noise Figure; $V_{CE} = 2.7\text{ V}$, $I_C = 5\text{ mA}$	f = 0.9 GHz		1.1 ^[2]	1.4 ^[2]
G_A	Associated Gain; $V_{CE} = 2.7\text{ V}$, $I_C = 5\text{ mA}$	f = 0.9 GHz	12.5 ^[2]	14.5 ^[2]	
h_{FE}	Forward Current Transfer Ratio; $V_{CE} = 2.7\text{ V}$, $I_C = 5\text{ mA}$	—	50		270
I_{CBO}	Collector Cutoff Current; $V_{CB} = 3\text{ V}$				0.2
I_{EBO}	Noise Figure; $V_{EB} = 1\text{ V}$				1.5

Notes:

1. All data is per individual transistor.
2. Test circuit, Figure 1. Numbers reflect device performance de-embedded from circuit losses. Input loss = 0.2 dB; output loss = 0.3 dB.

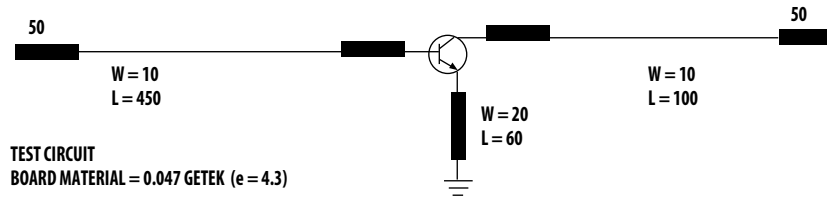

DIMENSIONS IN MILS
NOT TO SCALE

Figure 1. Test circuit for Noise Figure and Associated Gain.
This circuit is a compromise match between best noise figure, best gain, stability, and a practical synthesizable match.

AT-32063 Characterization Information, $T_A = 25^\circ\text{C}$

Symbol	Parameters and Test Conditions	Units	Typ.	
$P_{1\text{dB}}$	Power at 1 dB Gain Compression (opt tuning); $V_{CE} = 2.7\text{ V}$, $I_C = 20\text{ mA}$	f = 0.9 GHz	dBm	12
$G_{1\text{dB}}$	Gain at 1 dB Gain Compression (opt tuning); $V_{CE} = 2.7\text{ V}$, $I_C = 20\text{ mA}$	f = 0.9 GHz	dB	16
IP_3	Output Third Order Intercept Point (opt tuning); $V_{CE} = 2.7\text{ V}$, $I_C = 20\text{ mA}$	f = 0.9 GHz	dBm	24

Typical Performance, $T_A = 25^\circ\text{C}$

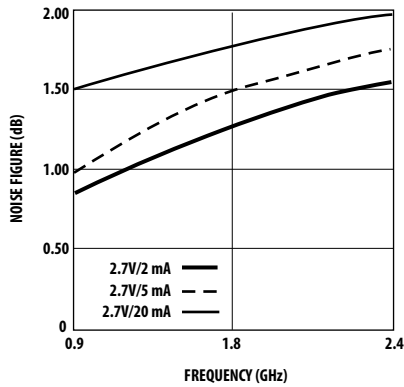

Figure 2. Minimum Noise Figure vs. Frequency and Current at $V_{CE} = 2.7\text{ V}$.

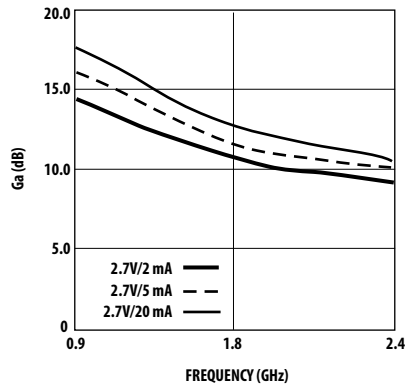

Figure 3. Associated Gain at Optimum Noise Match vs. Frequency and Current at $V_{CE} = 2.7\text{ V}$.

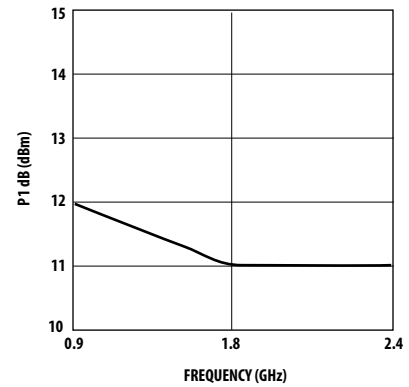

Figure 4. Power at 1 dB Gain Compression vs. Frequency at $V_{CE} = 2.7\text{ V}$ and $I_C = 20\text{ mA}$.

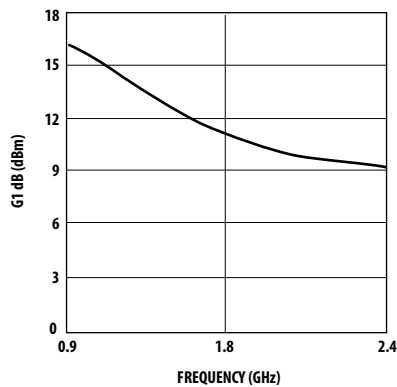

Figure 5. 1 dB Compressed Gain vs. Frequency at $V_{CE} = 2.7\text{ V}$ and $I_C = 20\text{ mA}$.

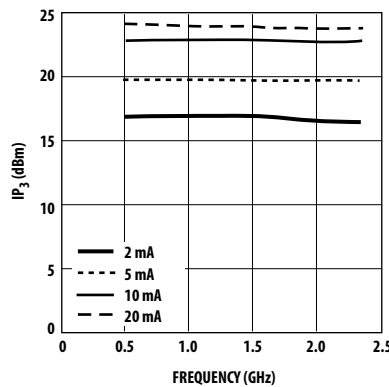

Figure 6. Third Order Intercept vs. Frequency and Bias at $V_{CE} = 2.7\text{ V}$, with Optimal Tuning.

AT-32063 Typical Scattering Parameters, Common Emitter, $Z_o = 50 \Omega, V_{CE} = 1 V, I_C = 1 \text{ mA}$

Freq. GHz	S_{11}			S_{21}			S_{12}		S_{22}	
	Mag	Ang	dB	Mag	Ang	dB	Mag	Ang	Mag	Ang
0.1	0.98	-11	11.36	3.7	171	-34.77	0.02	83	0.99	-4
0.5	0.86	-50	10.14	3.21	138	-22.02	0.08	59	0.91	-20
0.9	0.72	-82	8.39	2.63	113	-18.97	0.11	43	0.82	-31
1.0	0.69	-88	7.87	2.48	108	-18.61	0.12	41	0.8	-32
1.5	0.58	-119	5.87	1.97	85	-17.8	0.13	31	0.73	-41
1.8	0.52	-134	4.83	1.74	74	-17.72	0.13	28	0.7	-45
2.0	0.49	-145	4.3	1.64	67	-17.69	0.13	28	0.68	-48
2.4	0.45	-165	3.16	1.44	55	-17.68	0.13	30	0.67	-54
3.0	0.41	166	1.84	1.24	39	-16.99	0.14	37	0.64	-63
4.0	0.42	124	0.17	1.02	16	-13.67	0.21	45	0.6	-81
5.0	0.47	93	-1.15	0.88	-2	-9.84	0.32	38	0.54	-107

AT-32063 Typical Noise Parameters

Common Emitter, $Z_o = 50 \Omega, V_{CE} = 1 V, I_C = 1 \text{ mA}$

Freq. GHz	F_{min} dB	G_{opt} dB	R_n Mag.	Ang.	—
0.9	0.71	10.4	0.76	50	0.44
1.8	1.37	8.3	0.60	112	0.24
2.4	1.80	7.2	0.50	155	0.10

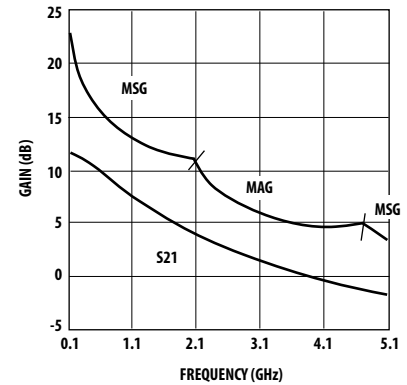

Figure 7. Gain vs. Frequency at $V_{CE} = 1 V, I_C = 1 \text{ mA}$.

AT-32063 Typical Scattering Parameters, Common Emitter, $Z_o = 50 \Omega, V_{CE} = 2.7 V, I_C = 2 \text{ mA}$

Freq. GHz	S_{11}			S_{21}			S_{12}		S_{22}	
	Mag	Ang	dB	Mag	Ang	dB	Mag	Ang	Mag	Ang
0.1	0.96	-12	16.46	6.66	169	-37.32	0.014	82	0.98	-5
0.5	0.77	-55	14.73	5.45	132	-25.13	0.055	59	0.87	-21
0.9	0.59	-87	12.37	4.15	107	-22.42	0.076	48	0.76	-29
1.0	0.55	-93	11.74	3.86	103	-22.07	0.079	47	0.74	-30
1.5	0.42	-121	9.26	2.90	83	-20.79	0.091	44	0.69	-36
1.8	0.37	-135	8.01	2.52	73	-20.13	0.099	45	0.67	-39
2.0	0.34	-145	7.35	2.33	67	-19.67	0.104	46	0.66	-41
2.4	0.29	-164	6.05	2.01	56	-18.68	0.116	48	0.65	-46
3.0	0.26	167	4.54	1.69	41	-16.95	0.142	50	0.64	-53
4.0	0.28	124	2.73	1.37	20	-13.75	0.205	48	0.61	-68
5.0	0.33	94	1.36	1.17	1	-10.70	0.292	41	0.57	-89

AT-32063 Typical Noise Parameters

Common Emitter, $Z_o = 50 \Omega, V_{CE} = 2.7 V, I_C = 2 \text{ mA}$

Freq. GHz	F_{min} dB	G_{opt} dB	R_n Mag.	Ang.	—
0.9	0.78	14.3	0.65	50	0.31
1.8	1.25	10.7	0.45	105	0.20
2.4	1.57	9.1	0.35	145	0.13

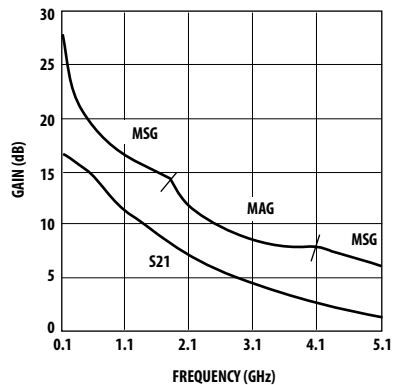

Figure 8. Gain vs. Frequency at $V_{CE} = 2.7 V, I_C = 2 \text{ mA}$.

AT-32063 Typical Scattering Parameters, Common Emitter, $Z_o = 50 \Omega, V_{CE} = 2.7 V, I_C = 5 \text{ mA}$

Freq. GHz	S_{11}			S_{21}			S_{12}		S_{22}	
	Mag	Ang	dB	Mag	Ang	dB	Mag	Ang	Mag	Ang
0.1	0.87	-19	23.36	14.72	162	-37.77	0.013	80	0.96	-9
0.5	0.52	-72	19.21	9.13	116	-27.03	0.045	60	0.72	-25
0.9	0.34	-101	15.40	5.89	94	-24.01	0.063	58	0.62	-28
1.0	0.31	-106	14.60	5.37	90	-23.41	0.067	58	0.61	-29
1.5	0.22	-129	11.54	3.77	74	-20.85	0.091	58	0.58	-33
1.8	0.19	-141	10.12	3.21	66	-19.52	0.106	58	0.57	-36
2.0	0.17	-150	9.33	2.93	61	-18.72	0.116	57	0.57	-38
2.4	0.14	-169	7.95	2.50	52	-17.22	0.138	56	0.57	-42
3.0	0.12	160	6.34	2.08	39	-15.25	0.173	52	0.56	-49
4.0	0.16	117	4.46	1.67	20	-12.40	0.240	44	0.53	-63
5.0	0.22	93	3.15	1.44	2	-10.03	0.315	33	0.48	-82

AT-32063 Typical Noise Parameters

Common Emitter, $Z_o = 50 \Omega, V_{CE} = 2.7 V, I_C = 5 \text{ mA}$

Freq. GHz	F_{min}	G_{opt}	R_n	—		
GHz	dB	dB	Mag.	Ang.	—	
0.9	0.98	16.4	0.45	51	0.23	
1.8	1.50	11.6	0.29	100	0.16	
2.4	1.77	10.1	0.33	153	0.11	

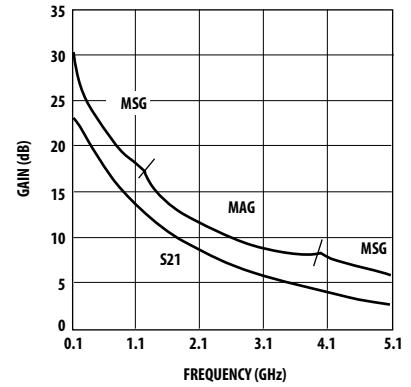

Figure 9. Gain vs. Frequency at $V_{CE} = 2.7 V, I_C = 5 \text{ mA}$.

AT-32063 Typical Scattering Parameters, Common Emitter, $Z_o = 50 \Omega, V_{CE} = 2.7 V, I_C = 20 \text{ mA}$

Freq. GHz	S_{11}			S_{21}			S_{12}		S_{22}	
	Mag	Ang	dB	Mag	Ang	dB	Mag	Ang	Mag	Ang
0.1	0.55	-41	30.48	33.40	143	-39.81	0.010	74	0.83	-15
0.5	0.20	-107	21.24	11.53	97	-29.18	0.035	72	0.56	-20
0.9	0.13	-137	16.48	6.66	82	-24.63	0.059	72	0.53	-22
1.0	0.13	-141	15.60	6.02	79	-23.79	0.065	71	0.53	-22
1.5	0.10	-164	12.26	4.10	67	-20.43	0.095	68	0.52	-27
1.8	0.09	-178	10.78	3.46	60	-18.88	0.114	66	0.53	-31
2.0	0.09	172	9.93	3.14	56	-17.98	0.126	64	0.53	-34
2.4	0.08	152	8.52	2.67	48	-16.39	0.151	60	0.53	-39
3.0	0.10	127	6.85	2.20	36	-14.4	0.191	54	0.52	-47
4.0	0.15	101	4.92	1.76	18	-11.68	0.261	43	0.48	-61
5.0	0.21	86	3.59	1.51	0	-9.52	0.334	31	0.44	-79

AT-32063 Typical Noise Parameters

Common Emitter, $Z_o = 50 \Omega, V_{CE} = 2.7 V, I_C = 20 \text{ mA}$

Freq. GHz	F_{min}	G_{opt}	R_n	—		
GHz	dB	dB	Mag.	Ang.	—	
0.9	1.51	17.9	0.13	88	0.20	
1.8	1.78	12.7	0.20	178	0.13	
2.4	1.96	10.6	0.28	235	0.08	

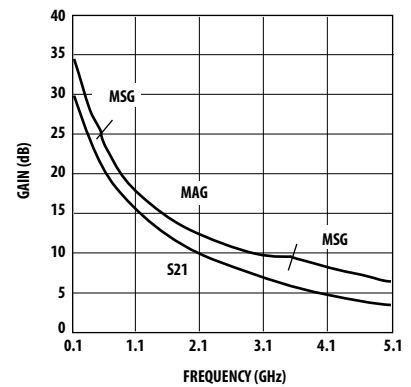

Figure 10. Gain vs. Frequency at $V_{CE} = 2.7 V, I_C = 20 \text{ mA}$.

AT-32063 Typical Scattering Parameters, Common Emitter, $Z_o = 50 \Omega, V_{CE} = 5 V, I_C = 2 \text{ mA}$

Freq. GHz	S_{11}			S_{21}			S_{12}		S_{22}	
	Mag	Ang	dB	Mag	Ang	dB	Mag	Ang	Mag	Ang
0.1	0.96	-12	16.50	6.69	169	-38.44	0.012	82	0.98	-5
0.5	0.78	-53	14.84	5.52	133	-26.20	0.049	60	0.88	-19
0.9	0.59	-84	12.5	4.23	108	-23.4	0.068	50	0.79	-27
1.0	0.56	-90	11.92	3.94	104	-23.04	0.070	49	0.77	-28
1.5	0.42	-117	9.46	2.97	84	-21.71	0.082	46	0.72	-33
1.8	0.36	-131	8.21	2.57	74	-21.04	0.089	47	0.70	-36
2.0	0.33	-140	7.55	2.38	68	-20.56	0.094	48	0.69	-39
2.4	0.28	-159	6.24	2.05	57	-19.54	0.105	50	0.69	-43
3.0	0.24	171	4.72	1.72	43	-17.76	0.129	53	0.68	-50
4.0	0.25	126	2.88	1.39	21	-14.47	0.189	52	0.66	-64
5.0	0.31	95	1.49	1.19	3	-11.32	0.272	45	0.63	-83

AT-32063 Typical Noise Parameters

Common Emitter, $Z_o = 50 \Omega, V_{CE} = 5 V, I_C = 2 \text{ mA}$

Freq. GHz	F_{min}	G_{opt}	R_n	dB	dB	Mag.	Ang.	—
0.9	0.75	13.7	0.74	47	0.37			
1.8	1.26	10.8	0.55	101	0.22			
2.4	1.60	9.6	0.45	139	0.13			

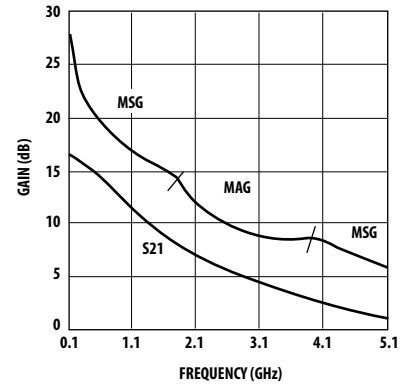

Figure 11. Gain vs. Frequency at $V_{CE} = 5 V, I_C = 2 \text{ mA}$.

AT-32063 Typical Scattering Parameters, Common Emitter, $Z_o = 50 \Omega, V_{CE} = 5 V, I_C = 20 \text{ mA}$

Freq. GHz	S_{11}			S_{21}			S_{12}		S_{22}	
	Mag	Ang	dB	Mag	Ang	dB	Mag	Ang	Mag	Ang
0.1	0.61	-36	30.56	33.74	145	-40.46	0.01	75	0.86	-14
0.5	0.22	-91	21.75	12.23	98	-29.90	0.03	72	0.6	-19
0.9	0.13	-115	17.02	7.10	83	-25.40	0.05	72	0.57	-21
1.0	0.12	-118	16.14	6.41	81	-24.56	0.06	71	0.57	-21
1.5	0.08	-137	12.80	4.36	68	-21.23	0.09	69	0.57	-26
1.8	0.06	-148	11.31	3.68	62	-19.69	0.10	66	0.57	-30
2.0	0.06	-159	10.46	3.33	58	-18.79	0.12	65	0.57	-32
2.4	0.04	175	9.02	2.83	50	-17.21	0.14	61	0.57	-37
3.0	0.05	131	7.35	2.33	39	-15.22	0.17	56	0.56	-45
4.0	0.10	99	5.39	1.86	21	-12.48	0.24	46	0.54	-58
5.0	0.16	86	4.05	1.6	3	-10.27	0.31	34	0.50	-75

AT-32063 Typical Noise Parameters

Common Emitter, $Z_o = 50 \Omega, V_{CE} = 5 V, I_C = 20 \text{ mA}$

Freq. GHz	F_{min}	G_{opt}	R_n	dB	dB	Mag.	Ang.	—
0.9	1.50	18.6	0.18	74	0.20			
1.8	1.78	13.3	0.19	147	0.16			
2.4	1.96	11.3	0.24	198	0.14			

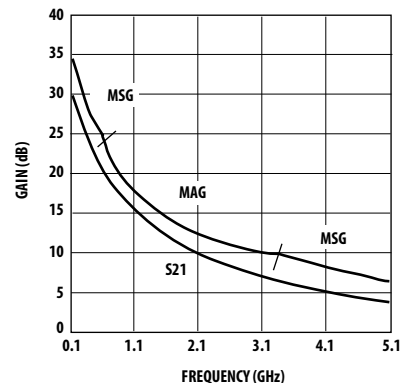

Figure 12. Gain vs. Frequency at $V_{CE} = 5 V, I_C = 20 \text{ mA}$.

Ordering Information

Part Numbers	No. of Devices	Comments
AT-32063-BLKG	100	Bulk
AT-32063-TR1G	3000	7" Reel
AT-32063-TR2G	10000	13" Reel

Package Dimensions

Outline 63 (SOT-363/SC-70)

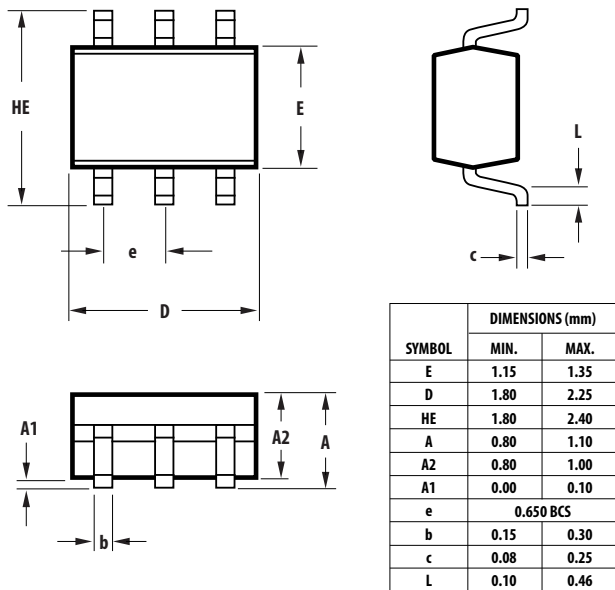

Device Orientation

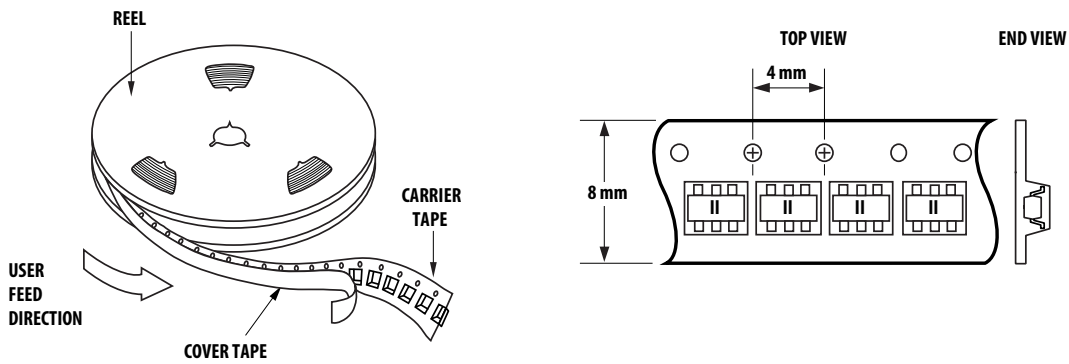

Tape Dimensions For Outline 63

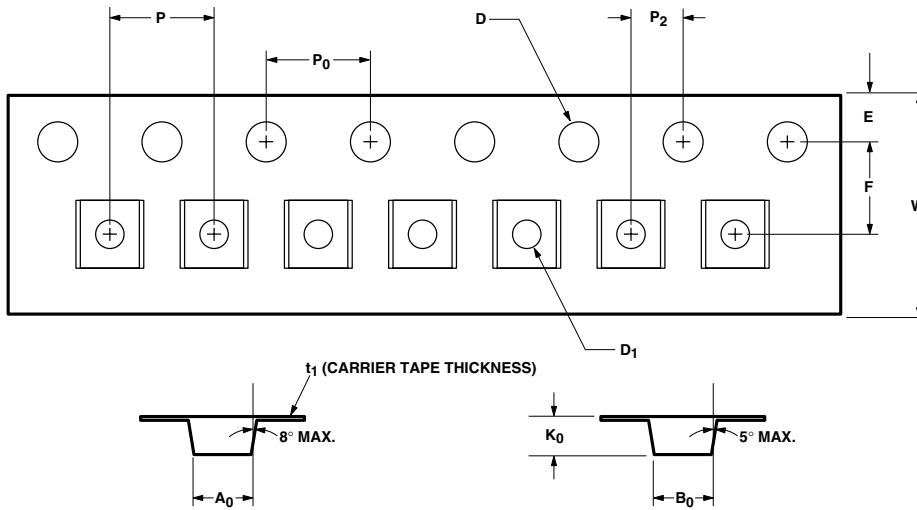

DESCRIPTION		SYMBOL	SIZE (mm)	SIZE (INCHES)
CAVITY	LENGTH	A_0	2.24 ± 0.10	0.088 ± 0.004
	WIDTH	B_0	2.34 ± 0.10	0.092 ± 0.004
	DEPTH	K_0	1.22 ± 0.10	0.048 ± 0.004
	PITCH	P	4.00 ± 0.10	0.157 ± 0.004
	BOTTOM HOLE DIAMETER	D_1	$1.00 + 0.25$	$0.039 + 0.010$
PERFORATION	DIAMETER	D	1.55 ± 0.05	0.061 ± 0.002
	PITCH	P_0	4.00 ± 0.10	0.157 ± 0.004
	POSITION	E	1.75 ± 0.10	0.069 ± 0.004
CARRIER TAPE	WIDTH	W	8.00 ± 0.30	0.315 ± 0.012
	THICKNESS	t_1	0.255 ± 0.013	0.010 ± 0.0005
DISTANCE	CAVITY TO PERFORATION (WIDTH DIRECTION)	F	3.50 ± 0.05	0.138 ± 0.002
	CAVITY TO PERFORATION (LENGTH DIRECTION)	P_2	2.00 ± 0.05	0.079 ± 0.002

For product information and a complete list of distributors, please go to our web site: www.avagotech.com

Avago, Avago Technologies, and the A logo are trademarks of Avago Technologies in the United States and other countries. Data subject to change. Copyright © 2005-2009 Avago Technologies. All rights reserved. Obsoletes 5989-2645EN AV02-1456EN - June 9, 2009

AVAGO
TECHNOLOGIES