

# Radiation Hardened Quad Differential Line Receiver

## HS-26C32RH, HS-26C32EH

The Intersil HS-26C32RH, HS-26C32EH are differential line receivers designed for digital data transmission over balanced lines and meets the requirements of EIA Standard RS-422. Radiation hardened CMOS processing assures low power consumption, high speed, and reliable operation in the most severe radiation environments.

The HS-26C32RH, HS-26C32EH have an input sensitivity typically of 200mV over the common mode input voltage range of  $\pm 7V$ . The receivers are also equipped with input fail safe circuitry, which causes the outputs to go to a logic “1” when the inputs are open. Enable and Disable functions are common to all four receivers.

Specifications for Rad Hard QML devices are controlled by the Defense Logistics Agency Land and Maritime (DLA). The SMD numbers listed in the “Ordering Information” table must be used when ordering.

Detailed Electrical Specifications for these devices are contained in SMD [5962-95689](#). A “hot-link” is provided on our homepage for downloading

## Features

- Electrically screened to SMD #[5962-95689](#)
- QML qualified per MIL-PRF-38535 requirements
- 1.2 micron radiation hardened CMOS
  - Total dose . . . . . 300 krad(Si) (max)
- Latch-up free
- EIA RS-422 compatible inputs
- CMOS compatible outputs
- Input fail safe circuitry
- High impedance inputs when disabled or powered down
- Low power dissipation 138mW standby (max)
- Single 5V supply
- Full -55°C to +125°C military temperature range

## Applications

- Line receiver for MIL-STD-1553 serial data bus

## Ordering Information

ORDERING NUMBER (Note 1)	INTERNAL MKT. NUMBER	PART MARKING	TEMP. RANGE (°C)	PACKAGE (Pb-free)	PKG. DWG. #
5962F9568901QEC	HS1-26C32RH-8	Q 5962F95 68901QEC	-55 to +125	16 Ld SBDIP	D16.3
5962F9568901QXC	HS9-26C32RH-8	Q 5962F95 68901QXC	-55 to +125	16 Ld FLATPACK	K16.A
5962F9568901V9A	HS0-26C32RH-Q		-55 to +125	Die	
HS0-26C32RH/SAMPLE	HS0-26C32RH/SAMPLE		-55 to +125	Die	
5962F9568901VEC	HS1-26C32RH-Q	Q 5962F95 68901VEC	-55 to +125	16 Ld SBDIP	D16.3
5962F9568901VXC	HS9-26C32RH-Q	Q 5962F95 68901VXC	-55 to +125	16 Ld FLATPACK	K16.A
HS1-26C32RH/PROTO	HS1-26C32RH/PROTO	HS1- 26C32RH /PROTO	-55 to +125	16 Ld SBDIP	D16.3
HS9-26C32RH/PROTO	HS9-26C32RH/PROTO	HS9- 26C32RH /PROTO	-55 to +125	16 Ld FLATPACK	K16.A
5962F9568903VEC	HS1-26C32EH-Q	Q 5962F95 68903VEC	-55 to +125	16 Ld SBDIP	D16.3
5962F9568903VXC	HS9-26C32EH-Q	Q 5962F95 68903VXC	-55 to +125	16 Ld FLATPACK	K16.A
5962F9568903V9A	HS0-26C32EH-Q	Q 5962F95 68903V9A	-55 to +125	Die	
5962F9568901VYC	HS9G-26C32RH-Q (Note 2)	Q 5962F95 68901VYC	-55 to +125	16 Ld FLATPACK	K16.A
HS9G-26C32RH/PROTO	HS9G-26C32RH/PROTO (Note 2)	HS9G-26C32RH/PROTO	-55 to +125	16 Ld FLATPACK	K16.A

### NOTES:

1. These Intersil Pb-free Hermetic packaged products employ 100% Au plate - e4 termination finish, which is RoHS compliant and compatible with both SnPb and Pb-free soldering operations.
2. The lid of these packages are connected to the ground pin of the device.

# HS-26C32RH, HS-26C32EH

## Logic Diagram

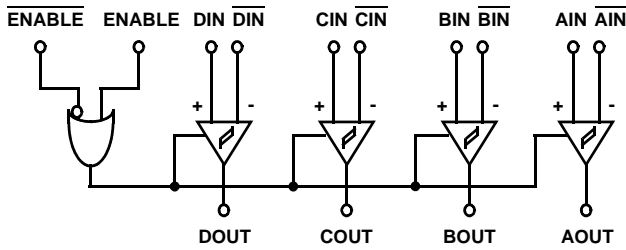

## Pin Configurations

HS1-26C32RH, HS1-26C32EH  
(16 LD SBDIP)  
MIL-STD-1835: CDIP2-T16  
TOP VIEW

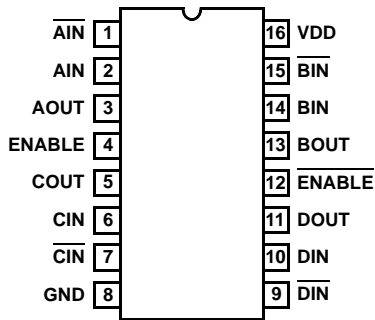

HS9-26C32RH, HS9-26C32EH  
(16 LD FLATPACK)  
MIL-STD-1835: CDFP4-F16  
TOP VIEW

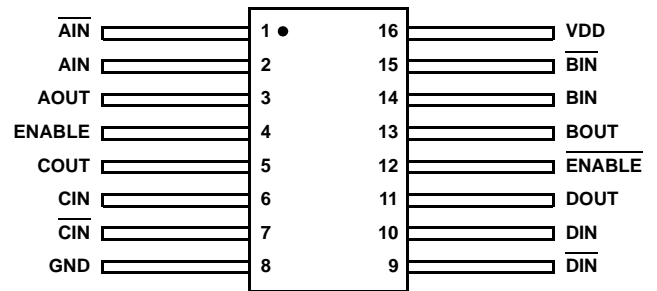

## Propagation Delay Timing Diagram

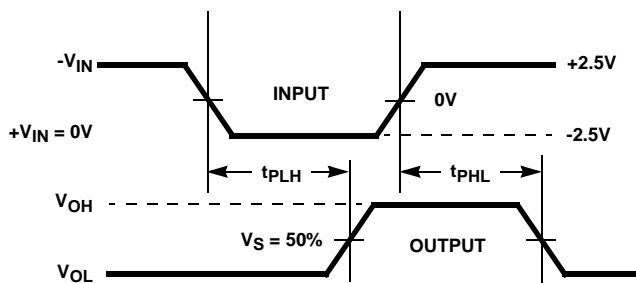

## Three-State Low Timing Diagram

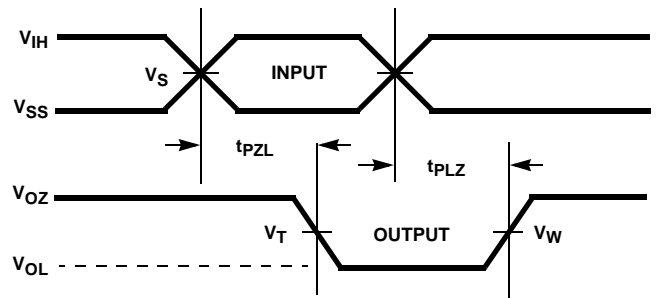

## Propagation Delay Load Circuit

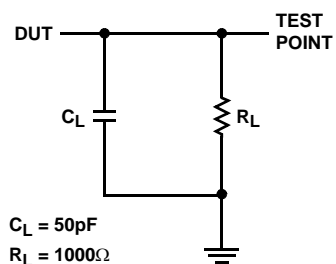

## Three-State Low Load Circuit

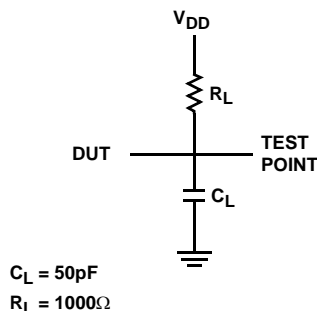

## Three-State High Timing Diagrams

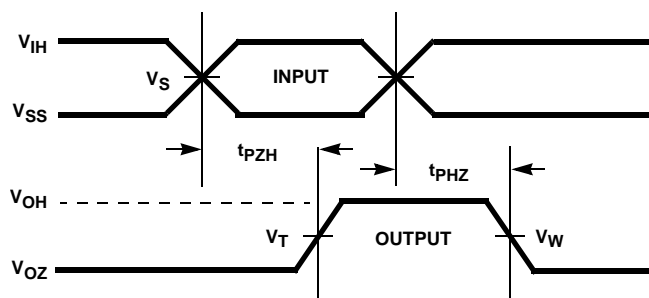

TABLE 1. THREE-STATE LOW VOLTAGE LEVELS

PARAMETER	HS-26C32RH HS-26C32EH	UNITS
V <sub>DD</sub>	4.50	V
V <sub>IH</sub>	4.50	V
V <sub>S</sub>	2.25	V
V <sub>T</sub>	50	%
V <sub>W</sub>	V <sub>OL</sub> + 0.5	V
GND	0	V

TABLE 2. THREE-STATE HIGH VOLTAGE LEVELS

PARAMETER	HS-26C32RH HS-26C32EH	UNITS
V <sub>DD</sub>	4.50	V
V <sub>IH</sub>	4.50	V
V <sub>S</sub>	2.25	V
V <sub>T</sub>	50	%
V <sub>W</sub>	V <sub>OH</sub> - 0.5	V
GND	0	V

## Three-State High Load Circuit

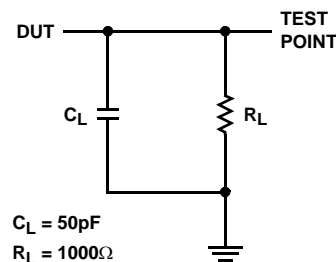

For additional products, see [www.intersil.com/en/products.html](http://www.intersil.com/en/products.html)

Intersil products are manufactured, assembled and tested utilizing ISO9000 quality systems as noted in the quality certifications found at [www.intersil.com/en/support/qualandreliability.html](http://www.intersil.com/en/support/qualandreliability.html)

Intersil products are sold by description only. Intersil Corporation reserves the right to make changes in circuit design, software and/or specifications at any time without notice. Accordingly, the reader is cautioned to verify that data sheets are current before placing orders. Information furnished by Intersil is believed to be accurate and reliable. However, no responsibility is assumed by Intersil or its subsidiaries for its use; nor for any infringements of patents or other rights of third parties which may result from its use. No license is granted by implication or otherwise under any patent or patent rights of Intersil or its subsidiaries.

For information regarding Intersil Corporation and its products, see [www.intersil.com](http://www.intersil.com)

# HS-26C32RH, HS-26C32EH

## Die Characteristics

### DIE DIMENSIONS:

78 mils x 123 mils  
(1970 $\mu$ m x 3120 $\mu$ m)

### INTERFACE MATERIALS:

#### Glassivation:

Type: SiO<sub>2</sub>  
Thickness: 10k $\text{Å}$   $\pm$  1k $\text{Å}$

### Top Metallization:

M1: Mo/TiW  
Thickness: 5800 $\text{Å}$   
M2: Al/Si/Cu  
Thickness: 5800 $\text{Å}$

### Worst Case Current Density:

$<2.0 \times 10^5 \text{A/cm}^2$

### Bond Pad Size:

110 $\mu$ m x 100 $\mu$ m

## Metallization Mask Layout

