

Features

- Single Outputs up to 20A
- Input/Output 1.6kVDC Isolation
- Adjustable Output Voltage
- No Minimum Load
- Under -Voltage Lockout
- Industry Standard Footprint
- Fixed Operating Frequency
- Halt Tested
- Compact 36.83 x 57.91 x 12.7mm Package
- High Efficiency to 91%

INNOLINE
DC/DC-Converter

RP50-SB Series

**50 Watt
Single
Output**

Selection Guide

Part Number	Input Voltage (VDC)	Output Voltage (VDC)	Output Current (A)	Load Regulation (mV)	Efficiency (5) %
RP50-481.8SB	36 – 75	1.8	20	5.4	87
RP50-482.5SB	36 – 75	2.5	20	7.5	89
RP50-483.3SB	36 – 75	3.3	15	10	90
RP50-4805SB	36 – 75	5.0	10	15	91

* add suffix "P" for positive logic ON/OFF control.



Description

The RP50-SB Series has been specifically designed for low voltage silicon applications. A wide input voltage range, output voltage trim and sense inputs are all standard features. The converters also benefit from comprehensive over-current, over-voltage and over-temperature protection. The RP50-SB is ideally suited to telecom, network and industrial applications.

RECOM

Notes:

1. Maximum output deviation is 10% inclusive of remote sense. If remote sense is not being used, the +Vsense should be connected to its corresponding +Vout
2. Standard is negative remote ON/OFF, add suffix "P" for positive remote ON/OFF.
3. Heat sink is optional and P/N: 7G-0021, 7G-0022, 7G-0023, 7G-0024.
4. The RP50-SB meets level A and level B conducted emissions only with external components connected before the input pin to the converter.
5. Typical value at nominal input voltage and full load.
6. BASEPLATE GROUNDING : Base-plate should be grounded at one of the four screw bolts prior to operation.

Specifications (refer to the standard application circuit, Ta: 25°C)

Input Voltage Range	36-75VDC	(48V nom.)
Under-Voltage Lockout	Power Up	34V typ.
	Power Down	32V typ.
Input Filter		L-C type
Input Surge Voltage 100ms max		100VDC
Start up time	Nominal Vin and constant resistive load	25ms typ.
Remote ON/OFF (Note 2)		
(Positive logic)	ON=Open or $3.0V < V_r < 15V$, OFF=Short or $0V < V_r < 1.2V$,	$I_{IN}=1mA$ max. $I_{IN}=1mA$ max.
(Negative logic)	ON=Short or $0V < V_r < 1.2V$, OFF=Open or $3.0V < V_r < 15V$,	$I_{IN}=1mA$ max. $I_{IN}=1mA$ max.
Continuous Output Power		50W max.
Output Voltage Accuracy	full load and nominal Vin	$\pm 1.5\%$
Output Voltage Adjustment (Note 1)		+10%, -20%
Minimum Load		0%
Line Regulation	low line to high line at full load	$\pm 0.2\%$
Load Regulation	0% to 100%full load	See table
Remote Sense (Note 1)		10% of Vout
Ripple and Noise 20MHz bandwidth	With 10 μ F tantalum and 1 μ F ceramic across output	100mVp-p
Temperature Coefficient		$\pm 0.02\%/^{\circ}C$
Transient Response Recovery Time	25% load step change	200 μ s
Over Voltage Protection threshold (Hiccup)		120% of Vout
Over Current Protection threshold		110% ~ 140% of Iout Rated
Short Circuit Protection		Hiccup, Automatic recovery
Efficiency (at nominal input voltage, full load)		up to 91%.
Isolation Voltage	Input to Output Input to Case Output to Case	1600VDC min. 1000VDC min. 1000VDC min.
Isolation Resistance		$10^7 \Omega$ min.
Isolation Capacitance		2500pF max.
Operating Frequency		270KHz typ.
Operating Temperature Range (Note 3)		-40°C to +100°C (base plate)
Over Temperature Protection		110°C
Storage Temperature Range		-55°C to +125°C
Humidity max., Non-condensing		95%
Thermal Shock		MIL-STD-810D
Vibration	10 ~ 55Hz 2G, 3minutes period, 30minutes analog	X, Y and Z
Humidity	Non Condensing	95% max.
Conducted Emissions	EN55022 (Note 4)	Level A
	EN55022 (Note 4)	Level B
Radiated Emissions	EN55022 (Note 4)	Level A

Continued on next page

Specifications (refer to the standard application circuit, Ta: 25°C)

ESD	EN61000-4-2	Perf. Criteria2
Radiated Immunity	EN61000-4-3	Perf. Criteria2
Fast Transient	EN61000-4-4	Perf. Criteria2
Surge	EN61000-4-5	Perf. Criteria2
Conducted Immunity	EN61000-4-6	Perf. Criteria2
Case Material	Open with Aluminium base plate	
Weight	42g	
MTBF Bellcore TR-NWT-000332, Tc=40°C, Io=80% max.	2500 x 10 ³ hours	

Characteristics

**Efficiency Input Voltage
RP50-4805SB**

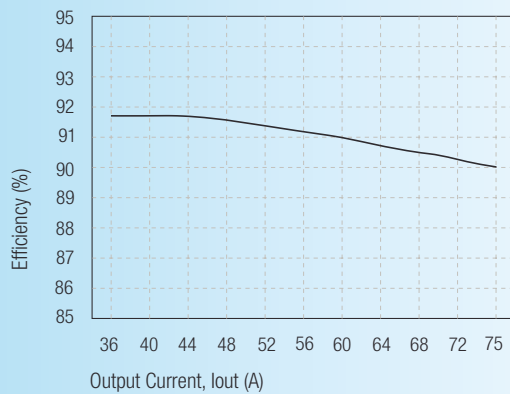

**Efficiency Output Current Iout
RP50-4805SB**

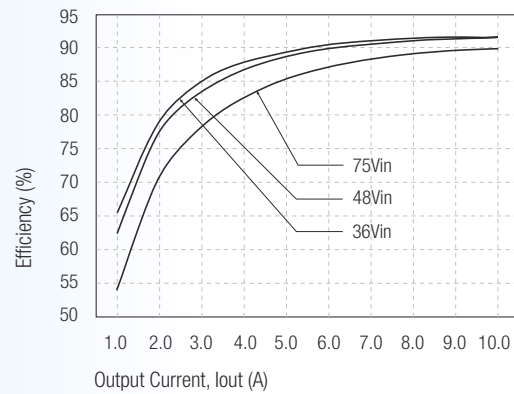

**Input Without Heatsink
RP50-4805SB**

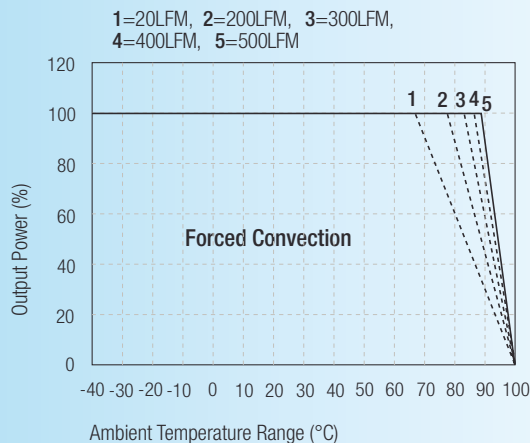

**Input With Heatsink (7G-0022)
RP50-4805SB**

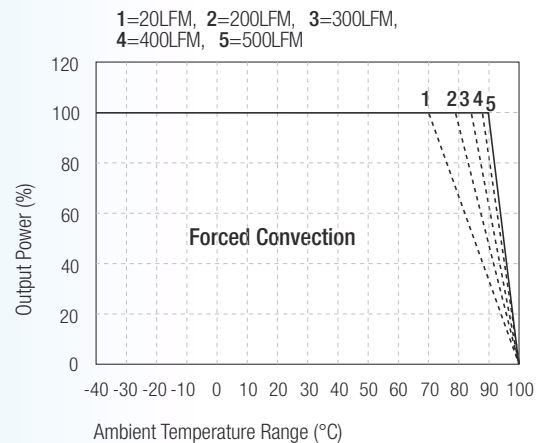

Package Style and Pinning (mm)

3rd angle projection 

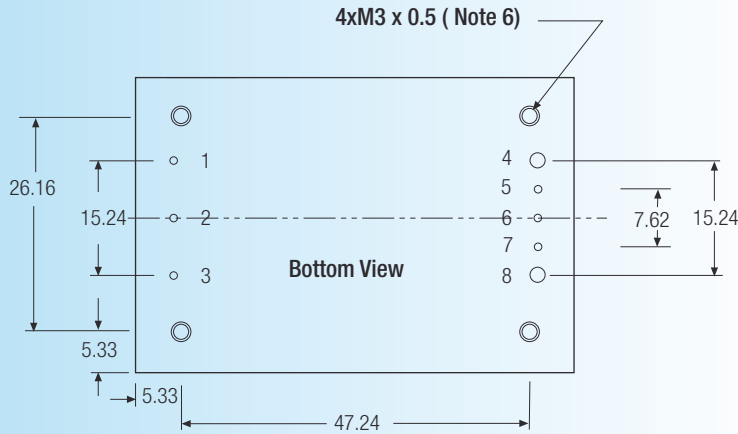
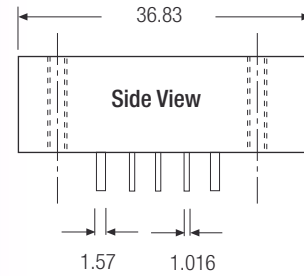
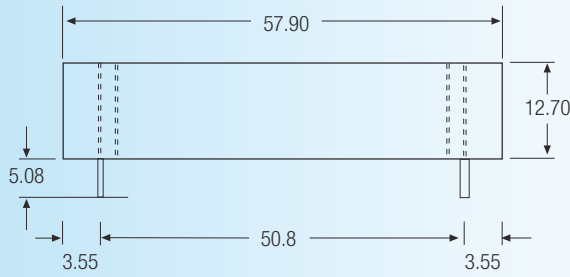

Pin Connections

Pin #	Function
1	-Vin
2	Remote ON/OFF
3	+Vin
4	-Vout
5	-Vsense
6	Trim
7	+Vsense
8	+Vout

XX.X ± 0.5 mm
XX.XX ± 0.25 mm
Pin pitch tolerance 0.35mm

External Output Trimming

Output can be externally trimmed by using the method shown below.

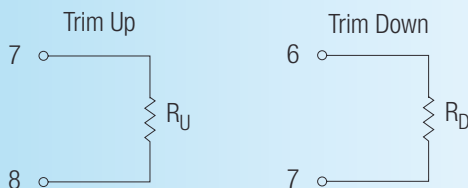

Trim Resistor Calculation:

$$R_{up} (k\Omega) = \frac{5.1V_{out} (100+\Delta\%) - 510}{1.225\Delta\%} - 10.2$$

$$R_{dn} (k\Omega) = \frac{510}{\Delta\%} - 10.2$$