

### LC503QPG1-30H-A

#### Features

5mm Package  
 High Optical Power  
 High Luminous Intensity  
 Water Clear Lens  
 All Plastic Mold Type  
 PRELIMINARY SPEC

#### Applications

Outdoor Message Centers  
 VMS  
 Automotive Interior Lighting  
 Traffic Signals  
 Pedestrian Signals  
 Decorative Lighting

#### Maximum Ratings (Ta=25°C)

Characteristic	Symbol	Max.	Unit
Forward Current	I <sub>F</sub>	25	mA
Reverse Voltage	V <sub>R</sub>	5	V
Power Dissipation	P <sub>D</sub>	105.00	mW
Operating Temperature	T <sub>opr</sub>	-40 ~ +95	°C
Storage Temperature	T <sub>stg</sub>	-40 ~ +100	°C
Soldering Temperature	T <sub>sol</sub>	260	°C
Soldering Time	-	for 3 sec. max	-

#### Opto-Electrical Characteristics (Ta=25°C)

Characteristic	Symbol	Test Condition	Min	Typ	Max	Unit
Forward Voltage	V <sub>F</sub>	I <sub>F</sub> =20mA	-	3.60	4.20	V
Reverse Current	I <sub>R</sub>	V <sub>R</sub> =5V	-	-	100	μA
Luminous Intensity	I <sub>v</sub>	I <sub>F</sub> =20mA	4180.00	7500.00	-	mcd
Viewing Angle	2θ <sup>1/2</sup>	-	-	30°	-	deg.
Peak Wavelength	λ <sub>p</sub>	I <sub>F</sub> =20mA	-	520	-	nm
Dominant Wavelength	λ <sub>d</sub>	I <sub>F</sub> =20mA	-	525	-	nm
Spectral Line Half Width	Δλ	I <sub>F</sub> =20mA	-	38	-	nm

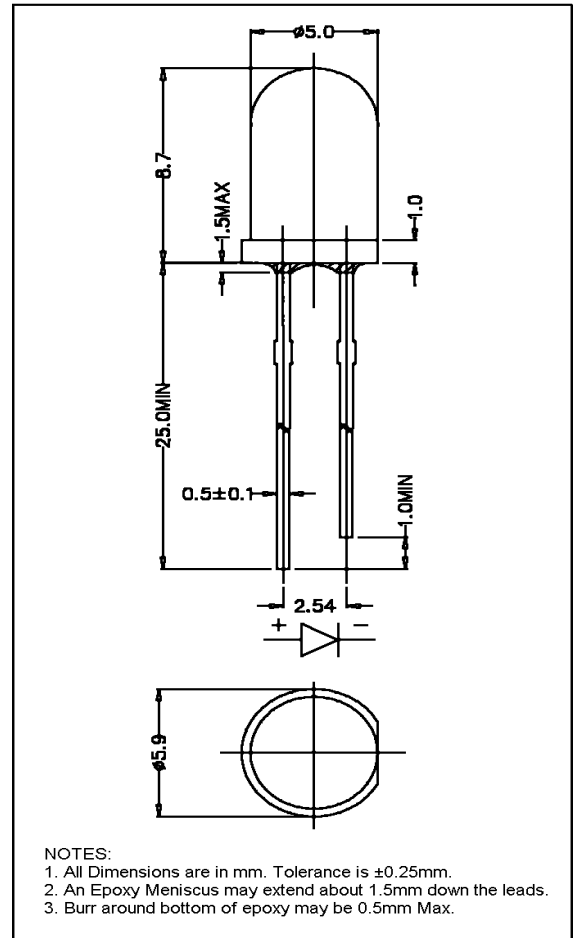

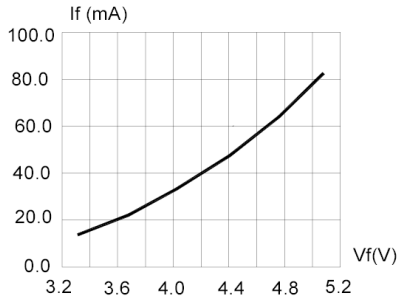

FIG.1 FORWARD CURRENT VS. FORWARD VOLTAGE.

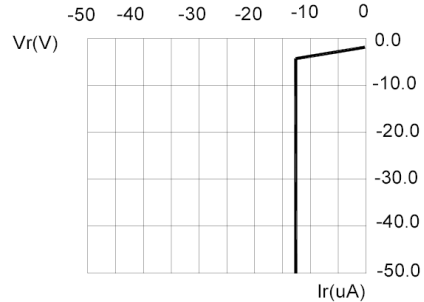

FIG.2 REVERSE CURRENT VS. REVERSE VOLTAGE.

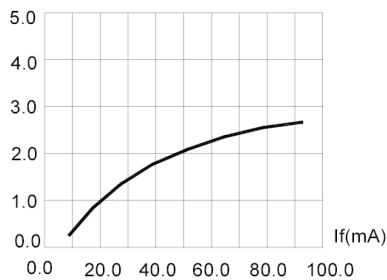

FIG.3 RELATIVE LUMINOUS INTENSITY VS. FORWARD CURRENT.

Half Power  $\Delta$  WL=38nm  
Domi WL= 525nm

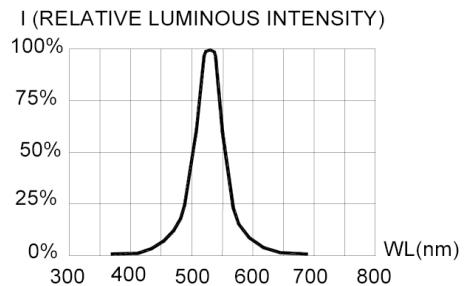

FIG.4 RELATIVE LUMINOUS INTENSITY VS. WAVELENGTH.

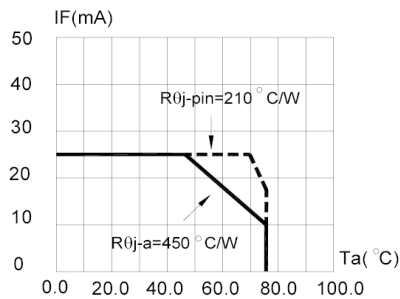

FIG.5 MAXIMUM FORWARD DC CURRENT VS AMBIENT TEMPERATURE ( $T_{jmax}=95^{\circ}\text{C}$ )

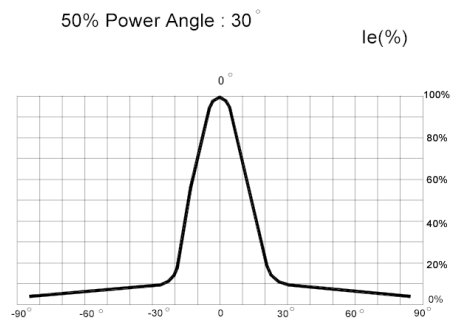

FIG.6 FAR FIELD PATTERN

1. Cathode PAD Area (0.18 X 0.18inch<sup>2</sup>)
2. Height above nominal seating plane in inches(0.3inch)