

BLA1011-300

Avionics LDMOS transistors

Rev. 02 — 5 February 2008

Product data sheet

1. Product profile

1.1 General description

300 W LDMOS pulsed power transistor for TCAS and IFF applications at frequencies from 1030 MHz to 1090 MHz.

Table 1. Typical performance

RF performance at $T_{case} = 25\text{ }^{\circ}\text{C}$ in a common source class-AB production test circuit; $t_p = 50\text{ }\mu\text{s}$; $\delta = 2\text{ }\%$.

Mode of operation	f (MHz)	I_{Dq} (mA)	V_{DS} (V)	P_L (W)	G_p (dB)	η_D (%)
Pulsed class-AB	1030 to 1090	150	32	300	16.5	57

CAUTION



This device is sensitive to ElectroStatic Discharge (ESD). Therefore care should be taken during transport and handling.

1.2 Features

- Typical performance at frequencies between 1030 MHz and 1090 MHz, a supply voltage of 32 V, an I_{Dq} of 150 mA, a t_p of 50 μs and a δ of 2 %:
 - ◆ Output power = 300 W
 - ◆ Power gain = 16.5 dB (typ)
 - ◆ Efficiency = 57 % (typ)
- Easy power control
- Excellent ruggedness
- High efficiency
- Excellent thermal stability
- Designed for operation in 1030 MHz to 1090 MHz band
- Internally matched for ease of use
- Compliant to Directive 2002/95/EC, regarding Restriction of Hazardous Substances (RoHS)

1.3 Applications

- RF power amplifiers for Avionics applications in the 1030 MHz to 1090 MHz frequency band

2. Pinning information

Table 2. Pinning

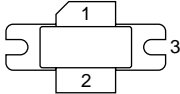
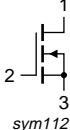
Pin	Description	Simplified outline	Symbol
1	drain		
2	gate		
3	source		

[1] Connected to flange

3. Ordering information

Table 3. Ordering information

Type number	Package		
	Name	Description	Version
BLA1011-300	-	flanged LDMOST ceramic package; 2 mounting holes; 2 leads	SOT957A

4. Limiting values

Table 4. Limiting values

In accordance with the Absolute Maximum Rating System (IEC 60134).

Symbol	Parameter	Conditions	Min	Max	Unit
V_{DS}	drain-source voltage		-	65	V
V_{GS}	gate-source voltage		-0.5	+15	V
I_D	drain current		-	15	A
T_{stg}	storage temperature		-65	+150	°C
T_j	junction temperature		-	200	°C

5. Thermal characteristics

Table 5. Thermal characteristics

Symbol	Parameter	Conditions	Typ	Max	Unit
$Z_{th(j-h)}$	transient thermal impedance from junction to heatsink	$T_{case} = 25\text{ °C}$; $t_p = 50\text{ }\mu\text{s}$; $\delta = 2\%$; $P_L = 300\text{ W}$	0.1	0.15	K/W

6. Characteristics

Table 6. Characteristics

$T_j = 25\text{ }^\circ\text{C}$ unless otherwise specified.

Symbol	Parameter	Conditions	Min	Typ	Max	Unit
$V_{(BR)DSS}$	drain-source breakdown voltage	$V_{GS} = 0\text{ V}; I_D = 3.75\text{ mA}$	65	-	-	V
$V_{GS(th)}$	gate-source threshold voltage	$V_{DS} = 20\text{ V}; I_D = 375\text{ mA}$	5.2	5.6	6.2	V
V_{GSq}	gate-source quiescent voltage	$V_{DS} = 32\text{ V}; I_D = 150\text{ mA}$	-	5.48	-	V
I_{DSS}	drain leakage current	$V_{GS} = 0\text{ V}; V_{DS} = 32\text{ V}$	-	-	3.3	μA
I_{DSX}	drain cut-off current	$V_{GS} = V_{GS(th)} + 6\text{ V}; V_{DS} = 10\text{ V}$	50	63	73	A
I_{GSS}	gate leakage current	$V_{GS} = 13\text{ V}; V_{DS} = 0\text{ V}$	-	-	60	nA
g_{fs}	forward transconductance	$V_{DS} = 20\text{ V}; I_D = 24\text{ A}$	-	15	-	S
$R_{DS(on)}$	drain-source on-state resistance	$V_{GS} = V_{GS(th)} + 6\text{ V}; I_D = 13.5\text{ A}$	-	55	80	$\text{m}\Omega$

7. Application information

Table 7. Application information

Mode of operation: Pulsed RF; $t_p = 50\text{ }\mu\text{s}$; $\delta = 2\%$; $V_{DS} = 32\text{ V}$; $I_{Dq} = 150\text{ mA}$; $T_{case} = 25\text{ }^\circ\text{C}$; unless otherwise specified.

Symbol	Parameter	Conditions	Min	Typ	Max	Unit
P_L	output power		300	-	-	W
G_p	power gain	$P_L = 300\text{ W}$	15	16.5	-	dB
RL_{in}	input return loss	$P_L = 300\text{ W}$	-	10	-	dB
η_D	drain efficiency	$P_L = 300\text{ W}$	52	57	-	%
t_r	rise time	$P_L = 300\text{ W}$	-	30	50	ns
t_f	fall time	$P_L = 300\text{ W}$	-	5	50	ns
$P_{droop(pulse)}$	pulse droop power	$P_L = 300\text{ W}$	-	0	0.2	dB

Table 8. Typical impedance

f	Z _S	Z _L
MHz	Ω	Ω
1030	4.25 – j3.57	1.27 – j0.33
1060	4.24 – j3.56	1.04 – j0.41
1090	4.47 – j3.71	0.91 – j0.60

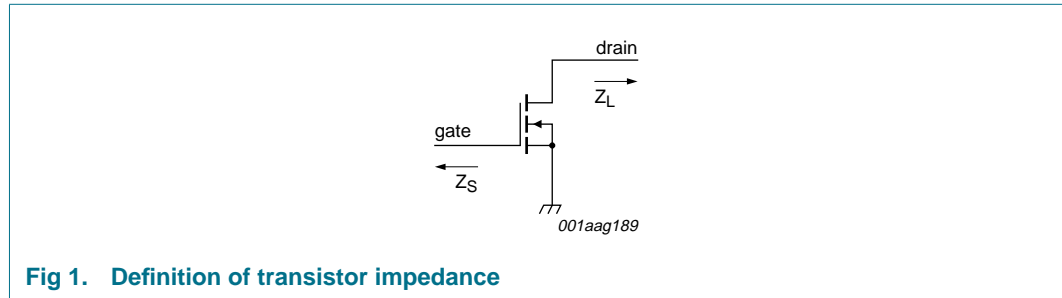
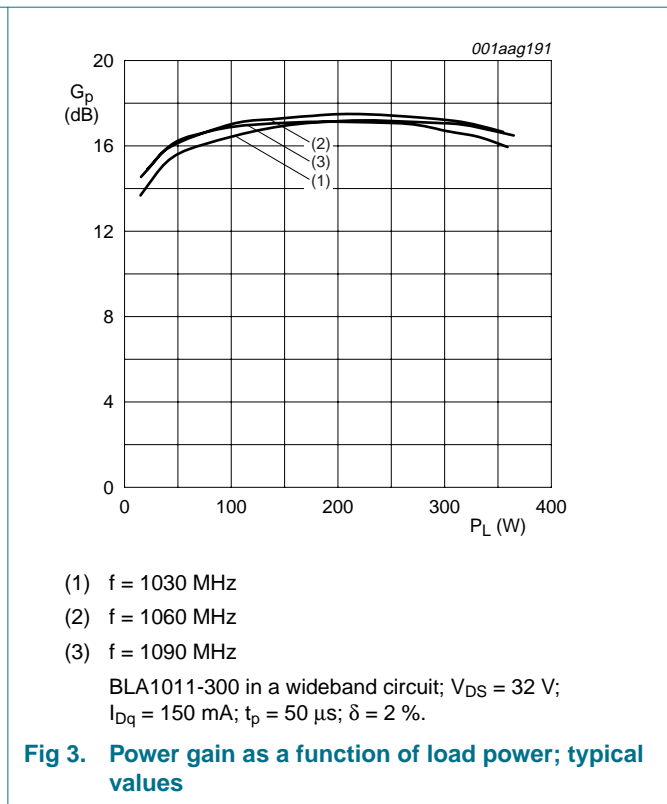
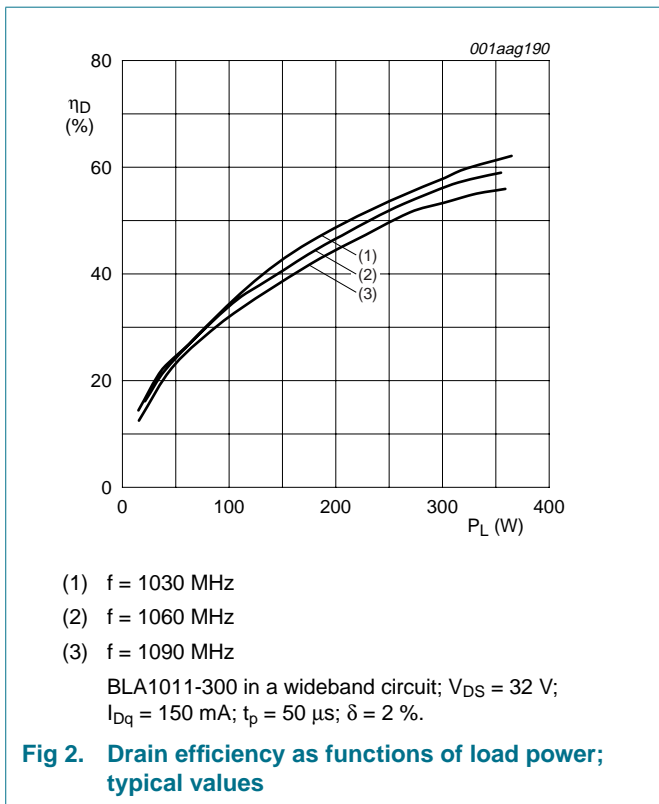
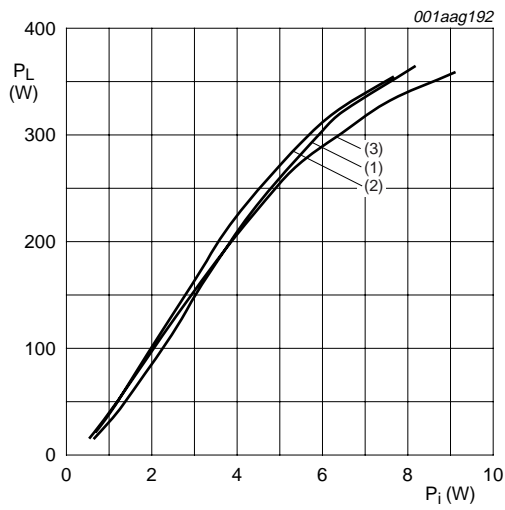

Fig 1. Definition of transistor impedance

7.1 Ruggedness in class-AB operation

The BLA1011-300 is capable of withstanding a load mismatch corresponding to VSWR = 10 : 1 through all phases under the following conditions: V_{DS} = 32 V; I_{Dq} = 150 mA; P_L = 300 W; f = 1030 MHz to 1090 MHz.





(1) $f = 1030$ MHz
 (2) $f = 1060$ MHz
 (3) $f = 1090$ MHz
 BLA1011-300 in a wideband circuit; $V_{DS} = 32$ V;
 $I_{Dq} = 150$ mA; $t_p = 50$ μ s; $\delta = 2$ %.

Fig 4. Load power as a function of input power; typical values

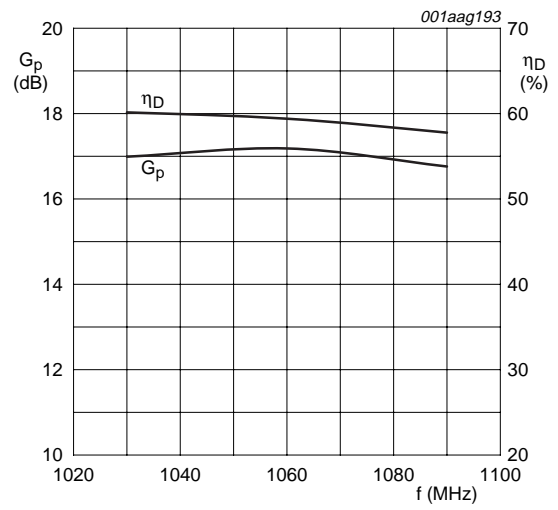

$V_{DS} = 32$ V; $I_{Dq} = 150$ mA; $t_p = 50$ μ s; $\delta = 2$ %.

Fig 5. Power gain and drain efficiency as functions of frequency; typical values

8. Test information

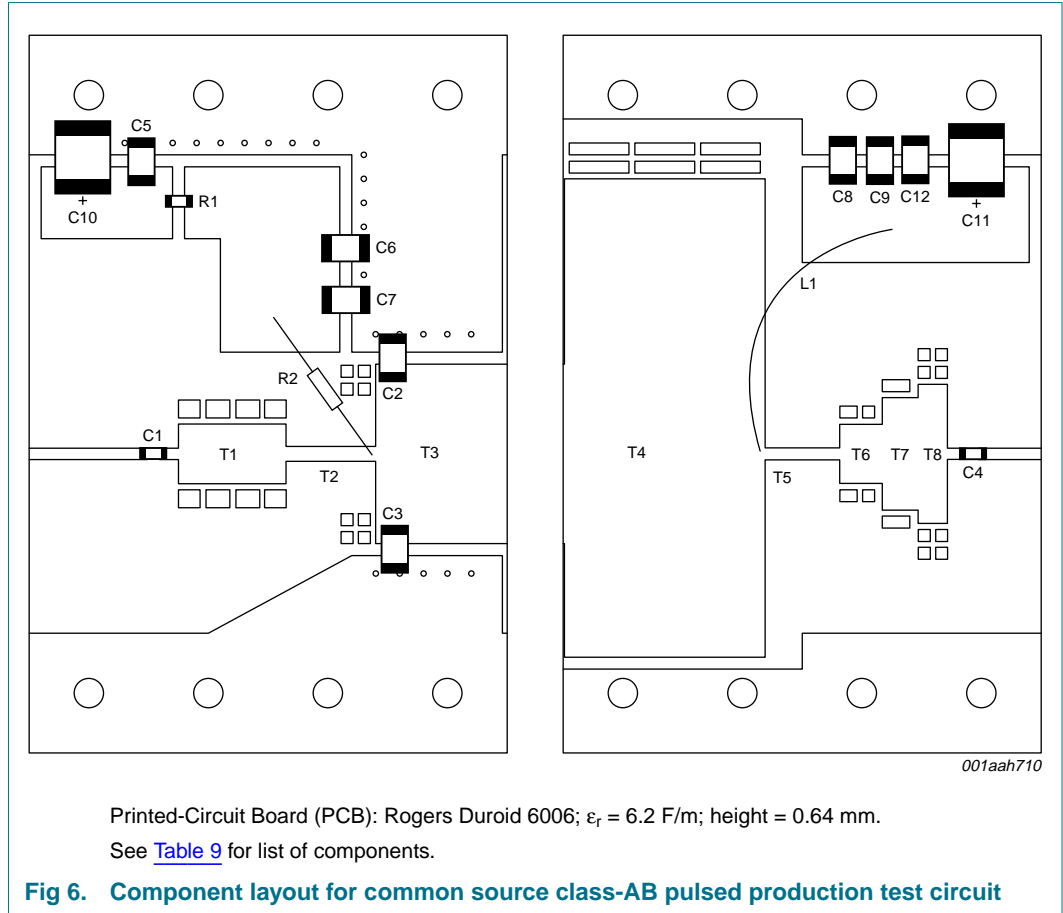

Table 9. List of components (see Figure 6)

To ensure good power supply of the device, adding an electrolytic capacitor close to the supply connection of the circuit may be required. The actual capacitor value may differ depending on the pulse format, the quality of the power supply and the length of the connecting wires to the power supply. In general a value of 470 μ F will be sufficient.

Component	Description	Value	Remarks
C1, C4	multilayer ceramic chip capacitor	62 pF	[1]
C2, C3	multilayer ceramic chip capacitor	1.5 pF	[2]
C5	multilayer ceramic chip capacitor	100 pF	[2]
C6, C8	multilayer ceramic chip capacitor	62 pF	[2]
C7	multilayer ceramic chip capacitor	10 pF	[2]
C9	multilayer ceramic chip capacitor	1.2 nF	[1]
C10	electrolytic capacitor	47 μ F; 20 V	
C11	electrolytic capacitor	47 μ F; 63 V	
C12	multilayer ceramic chip capacitor	47 pF	[1]
L1	Ω -shaped enameled copper wire	d = 1 mm; length = 38 mm	
R1	SMD resistor	18 Ω	0508 package

Table 9. List of components (see [Figure 6](#)) ...continued

To ensure good power supply of the device, adding an electrolytic capacitor close to the supply connection of the circuit may be required. The actual capacitor value may differ depending on the pulse format, the quality of the power supply and the length of the connecting wires to the power supply. In general a value of 470 μ F will be sufficient.

Component	Description	Value	Remarks
R2	metal film resistor	49.9 Ω	
T1	stripline	-	(W \times L) 5 mm \times 9 mm
T2	stripline	-	(W \times L) 1.25 mm \times 7.5 mm
T3	stripline	-	(W \times L) 15 mm \times 11 mm
T4	stripline	-	(W \times L) 40 mm \times 16.8 mm
T5	stripline	-	(W \times L) 1 mm \times 6.25 mm
T6	stripline	-	(W \times L) 4.95 mm \times 3.55 mm
T7	stripline	-	(W \times L) 9.4 mm \times 3 mm
T8	stripline	-	(W \times L) 12 mm \times 2.45 mm

[1] American Technical Ceramics type 100A or capacitor of same quality.

[2] American Technical Ceramics type 100B or capacitor of same quality.

9. Package outline

Flanged LDMOST ceramic package; 2 mounting holes; 2 leads

SOT957A

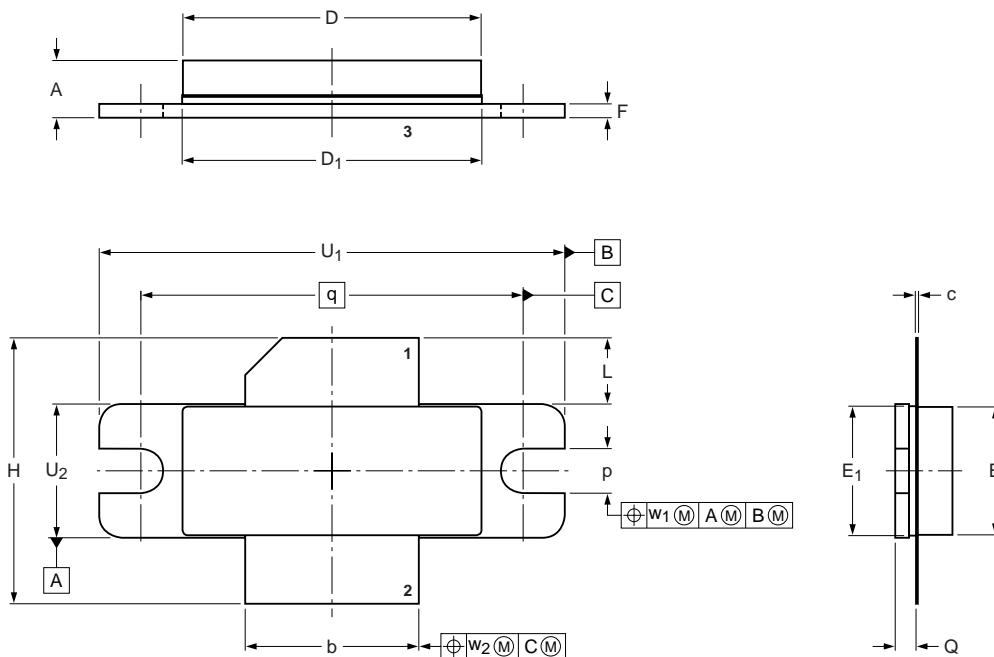

DIMENSIONS (mm are the original dimensions)

UNIT	A	b	c	D	D ₁	E	E ₁	F	H	L	P	Q	q	U ₁	U ₂	w ₁	w ₂
mm	4.67 4.08	12.83 12.57	0.15 0.10	22.07 21.62	22.04 21.64	9.53 9.27	9.55 9.25	1.14 0.89	19.94 18.92	5.33 4.31	3.38 3.12	1.70 1.45	27.94	34.16 33.91	9.91 9.65	0.25	0.25
inches	0.184 0.1605	0.505 0.495	0.006 0.004	0.869 0.851	0.868 0.852	0.375 0.365	0.376 0.364	0.045 0.035	0.785 0.745	0.210 0.170	0.133 0.123	0.067 0.057	1.100	1.345 1.335	0.390 0.380	0.01	0.01

OUTLINE VERSION	REFERENCES			EUROPEAN PROJECTION	ISSUE DATE
	IEC	JEDEC	JEITA		
SOT957A					06-06-29 07-03-01

Fig 7. Package outline SOT957A

10. Abbreviations

Table 10. Abbreviations

Acronym	Description
IFF	Identification Friend or Foe
LDMOS	Laterally Diffused Metal Oxide Semiconductor
LDMOST	Laterally Diffused Metal-Oxide Semiconductor Transistor
RF	Radio Frequency
TCAS	Traffic Collision Avoidance System
VSWR	Voltage Standing-Wave Ratio

11. Revision history

Table 11. Revision history

Document ID	Release date	Data sheet status	Change notice	Supersedes
BLA1011-300_2	20080205	Product data sheet	-	BLA1011-300_1
Modifications:				
				<ul style="list-style-type: none">• Section 1.2 "Features" on page 1: added RoHS compliance statement• Added Section 8 "Test information" on page 6.
BLA1011-300_1	20070403	Product data sheet	-	-

12. Legal information

12.1 Data sheet status

Document status ^{[1][2]}	Product status ^[3]	Definition
Objective [short] data sheet	Development	This document contains data from the objective specification for product development.
Preliminary [short] data sheet	Qualification	This document contains data from the preliminary specification.
Product [short] data sheet	Production	This document contains the product specification.

[1] Please consult the most recently issued document before initiating or completing a design.

[2] The term 'short data sheet' is explained in section "Definitions".

[3] The product status of device(s) described in this document may have changed since this document was published and may differ in case of multiple devices. The latest product status information is available on the Internet at URL <http://www.nxp.com>.

12.2 Definitions

Draft — The document is a draft version only. The content is still under internal review and subject to formal approval, which may result in modifications or additions. NXP Semiconductors does not give any representations or warranties as to the accuracy or completeness of information included herein and shall have no liability for the consequences of use of such information.

Short data sheet — A short data sheet is an extract from a full data sheet with the same product type number(s) and title. A short data sheet is intended for quick reference only and should not be relied upon to contain detailed and full information. For detailed and full information see the relevant full data sheet, which is available on request via the local NXP Semiconductors sales office. In case of any inconsistency or conflict with the short data sheet, the full data sheet shall prevail.

12.3 Disclaimers

General — Information in this document is believed to be accurate and reliable. However, NXP Semiconductors does not give any representations or warranties, expressed or implied, as to the accuracy or completeness of such information and shall have no liability for the consequences of use of such information.

Right to make changes — NXP Semiconductors reserves the right to make changes to information published in this document, including without limitation specifications and product descriptions, at any time and without notice. This document supersedes and replaces all information supplied prior to the publication hereof.

Suitability for use — NXP Semiconductors products are not designed, authorized or warranted to be suitable for use in medical, military, aircraft, space or life support equipment, nor in applications where failure or

malfunction of an NXP Semiconductors product can reasonably be expected to result in personal injury, death or severe property or environmental damage. NXP Semiconductors accepts no liability for inclusion and/or use of NXP Semiconductors products in such equipment or applications and therefore such inclusion and/or use is at the customer's own risk.

Applications — Applications that are described herein for any of these products are for illustrative purposes only. NXP Semiconductors makes no representation or warranty that such applications will be suitable for the specified use without further testing or modification.

Limiting values — Stress above one or more limiting values (as defined in the Absolute Maximum Ratings System of IEC 60134) may cause permanent damage to the device. Limiting values are stress ratings only and operation of the device at these or any other conditions above those given in the Characteristics sections of this document is not implied. Exposure to limiting values for extended periods may affect device reliability.

Terms and conditions of sale — NXP Semiconductors products are sold subject to the general terms and conditions of commercial sale, as published at <http://www.nxp.com/profile/terms>, including those pertaining to warranty, intellectual property rights infringement and limitation of liability, unless explicitly otherwise agreed to in writing by NXP Semiconductors. In case of any inconsistency or conflict between information in this document and such terms and conditions, the latter will prevail.

No offer to sell or license — Nothing in this document may be interpreted or construed as an offer to sell products that is open for acceptance or the grant, conveyance or implication of any license under any copyrights, patents or other industrial or intellectual property rights.

12.4 Trademarks

Notice: All referenced brands, product names, service names and trademarks are the property of their respective owners.

13. Contact information

For additional information, please visit: <http://www.nxp.com>

For sales office addresses, send an email to: salesaddresses@nxp.com

14. Contents

1	Product profile	1
1.1	General description	1
1.2	Features	1
1.3	Applications	1
2	Pinning information	2
3	Ordering information	2
4	Limiting values	2
5	Thermal characteristics	2
6	Characteristics	3
7	Application information	3
7.1	Ruggedness in class-AB operation	4
8	Test information	6
9	Package outline	8
10	Abbreviations	9
11	Revision history	9
12	Legal information	10
12.1	Data sheet status	10
12.2	Definitions	10
12.3	Disclaimers	10
12.4	Trademarks	10
13	Contact information	10
14	Contents	11

Please be aware that important notices concerning this document and the product(s) described herein, have been included in section 'Legal information'.



© NXP B.V. 2008.

All rights reserved.

For more information, please visit: <http://www.nxp.com>

For sales office addresses, please send an email to: salesaddresses@nxp.com

Date of release: 5 February 2008

Document identifier: BLA1011-300_2