

## LM102/LM302 Voltage Followers

### General Description

The LM102 series are high-gain operational amplifiers designed specifically for unity-gain voltage follower applications. Built on a single silicon chip, the devices incorporate advanced processing techniques to obtain very low input current and high input impedance. Further, the input transistors are operated at zero collector-base voltage to virtually eliminate high temperature leakage currents. It can therefore be operated in a temperature stabilized component oven to get extremely low input currents and low offset voltage drift.

The LM102, which is designed to operate with supply voltages between  $\pm 12V$  and  $\pm 15V$ , also features low input capacitance as well as excellent small signal and large signal frequency response—all of which minimize high fre-

quency gain error. Because of the low wiring capacitances inherent in monolithic construction, this fast operation can be realized without increasing power consumption.

### Features

- Fast slewing —  $10V/\mu s$
- Low input current — 10 nA (max)
- High input resistance — 10,000 M $\Omega$
- No external frequency compensation required
- Simple offset balancing with optional 1 k $\Omega$  potentiometer
- Plug-in replacement for both the LM101 and LM709 in voltage follower applications

### Schematic Diagram

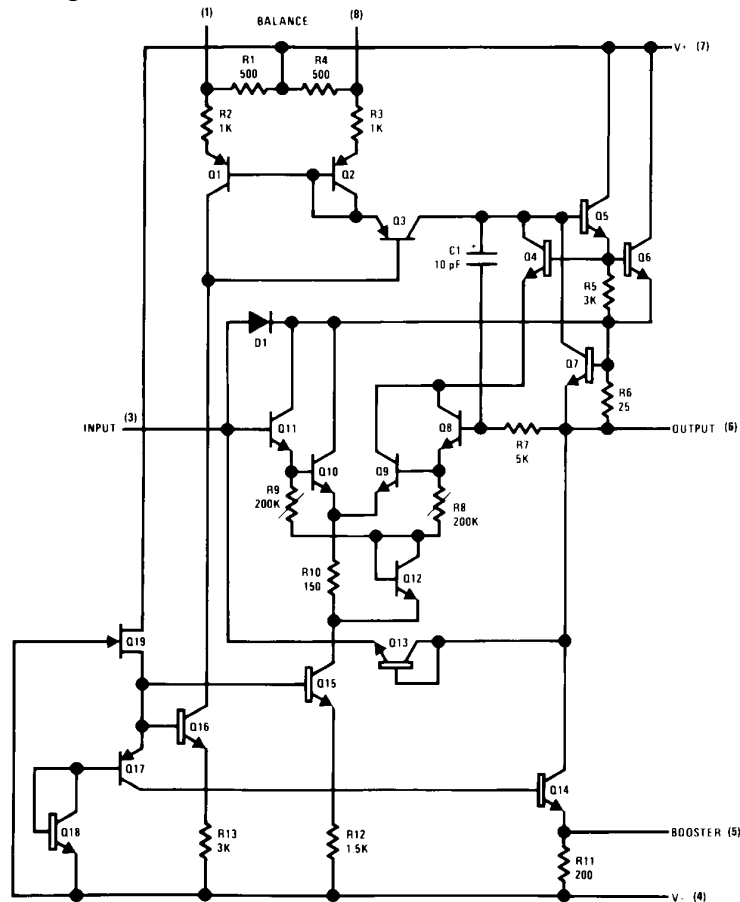

## Absolute Maximum Ratings

If Military/Aerospace specified devices are required, please contact the National Semiconductor Sales Office/Distributors for availability and specifications. (Note 6)

Supply Voltage	± 18V
Power Dissipation (Note 1)	500 mW
Input Voltage (Note 2)	± 15V
Output Short Circuit Duration (Note 3)	Indefinite

Operating Free Air Temperature Range	
LM102	– 55°C to + 125°C
LM302	0°C to + 70°C
Storage Temperature Range	– 65°C to + 150°C
Lead Temperature (Soldering, 10 sec.)	300°C
ESD rating to be determined.	

## Electrical Characteristics (Note 4)

Parameter	Conditions	LM102			LM302			Units
		Min	Typ	Max	Min	Typ	Max	
Input Offset Voltage	$T_A = 25^\circ\text{C}$		2	5		5	15	mV
Input Bias Current	$T_A = 25^\circ\text{C}$		3	10		10	30	nA
Input Resistance	$T_A = 25^\circ\text{C}$	$10^{10}$	$10^{12}$		$10^9$	$10^{12}$		$\Omega$
Input Capacitance				3.0		3.0		pF
Large Signal Voltage Gain	$T_A = 25^\circ\text{C}$ , $V_S = \pm 15\text{V}$ , $V_{OUT} = \pm 10\text{V}$ , $R_L = 8\text{ k}\Omega$	0.999	0.9996		0.9985	0.9995	1.0	V/V
Output Resistance	$T_A = 25^\circ\text{C}$		0.8	2.5		0.8	2.5	$\Omega$
Supply Current	$T_A = 25^\circ\text{C}$		3.5	5.5		3.5	5.5	mA
Input Offset Voltage				7.5			20	mV
Offset Voltage Temperature Drift			6			20		$\mu\text{V}/^\circ\text{C}$
Input Bias Current	$T_A = T_{A\text{MAX}}$ $T_A = T_{A\text{MIN}}$		3 30	10 100		3.0 20	15 50	nA nA
Large Signal Voltage Gain	$V_S = \pm 15\text{V}$ , $V_{OUT} = \pm 10\text{V}$ , $R_L = 10\text{ k}\Omega$	0.999						
Output Voltage Swing	$V_S = \pm 15\text{V}$ , $R_L = 10\text{ k}\Omega$ (Note 5)	± 10			± 10			V
Supply Current	$T_A = 125^\circ\text{C}$		2.6	4.0				mA
Supply Voltage Rejection Ratio	$\pm 12\text{V} \leq V_S \leq \pm 15\text{V}$	60			60			dB

**Note 1:** The maximum junction temperature of the LM102 is 150°C, while that of the LM302 is 85°C. For operating at elevated temperatures, devices in the H08 package must be derated based on a thermal resistance of 150°C/W, junction to ambient, or 20°C/W, junction to case.

**Note 2:** For supply voltages less than ± 15V, the absolute maximum input voltage is equal to the supply voltage.

**Note 3:** It is necessary to insert a resistor (at least 5k and preferably 10k) in series with the input pin when the amplifier is driven from low impedance sources to prevent damage when the output is shorted and to ensure stability.

**Note 4:** These specifications apply for  $\pm 12\text{V} \leq V_S \leq \pm 15\text{V}$  and  $-55^\circ\text{C} \leq T_A \leq 125^\circ\text{C}$  for the LM102 and  $0^\circ\text{C} \leq T_A \leq 70^\circ\text{C}$  for the LM302 unless otherwise specified.

**Note 5:** Increased output swing under load can be obtained by connecting an external resistor between the booster and  $V^-$  terminals. See curve.

**Note 6:** Refer to RETS102X for the LM102H military specifications.

### APPLICATION HINT

The input must be driven from a source impedance of typically 10 k $\Omega$  (5 k $\Omega$  Min) to maintain stability. The total source impedance will be reduced at high frequencies if there is stray capacitance at the input pin. In these cases, a 10 k $\Omega$  resistor should be inserted in series with the input, physically close to the input pin to minimize the stray capacitance and prevent oscillation.

## Guaranteed Performance Characteristics LM102

**Input Current**

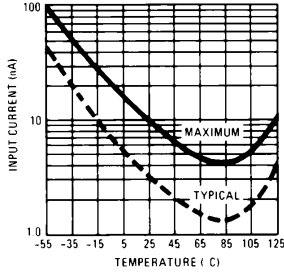

**Output Swing**

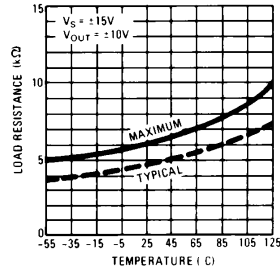

**Supply Current**

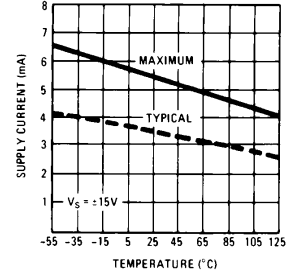

TL/H/7753-7

## Typical Performance Characteristics LM102

**Voltage Gain and Phase Lag**

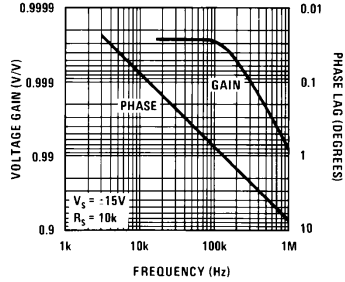

**Voltage Gain and Phase Lag**

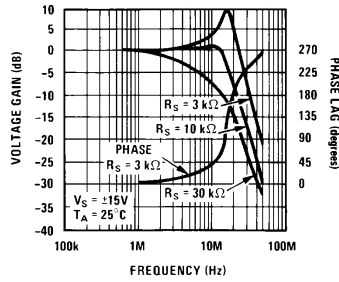

**Output Resistance**

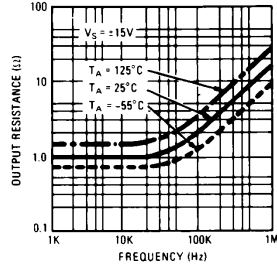

**Positive Output Swing**

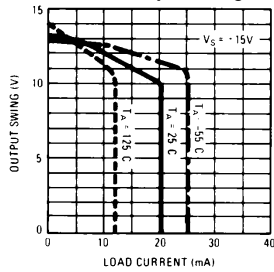

**Negative Output Swing**

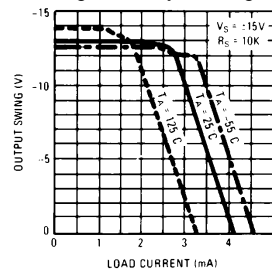

**Output Swing**

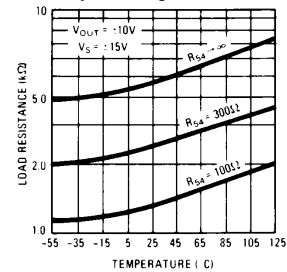

**Large Signal Frequency Response**

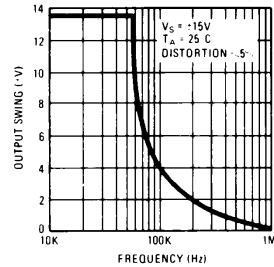

**Large Signal Pulse Response**

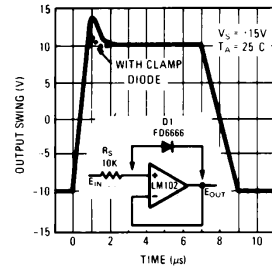

**Maximum Power Dissipation**

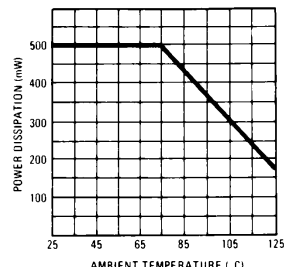

TL/H/7753-8

## Guaranteed Performance Characteristics LM302

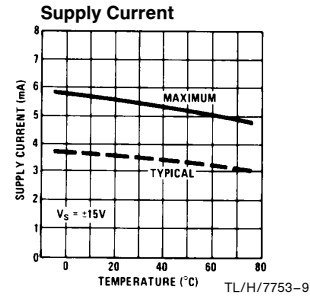
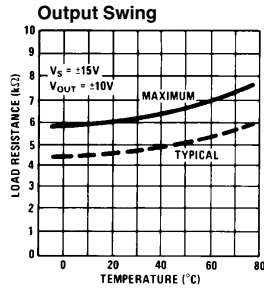
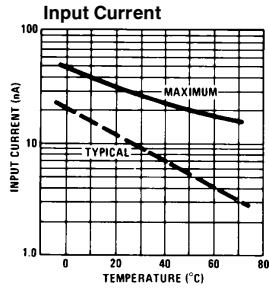

## Typical Performance Characteristics LM302

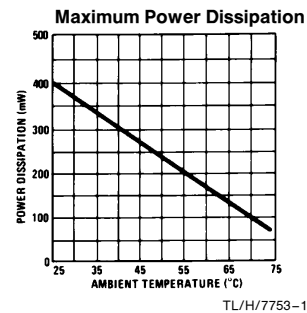
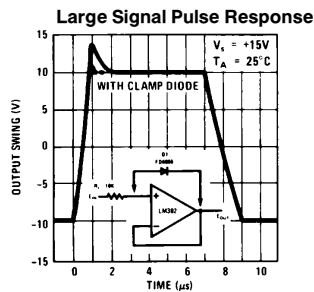
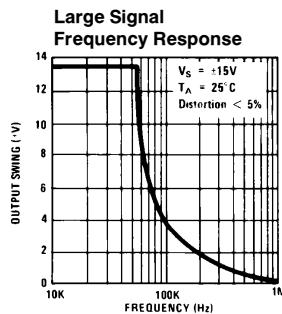
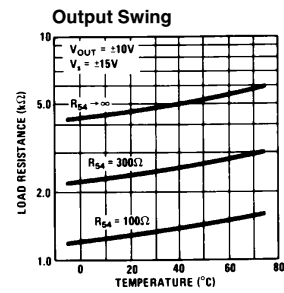
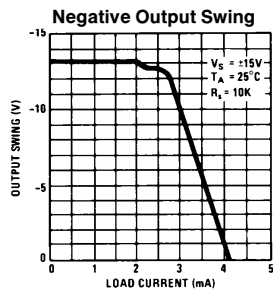
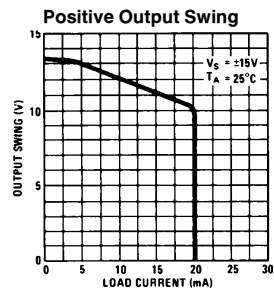
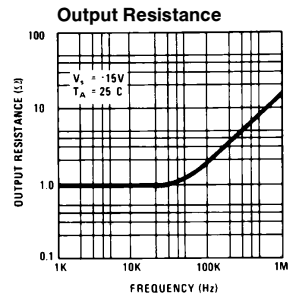
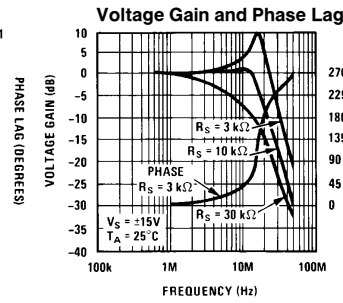
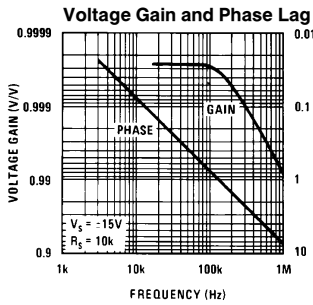

## Typical Applications

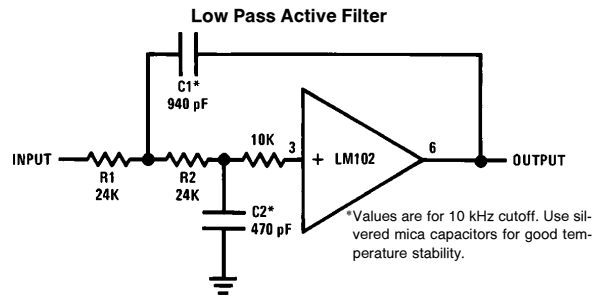

TL/H/7753-3

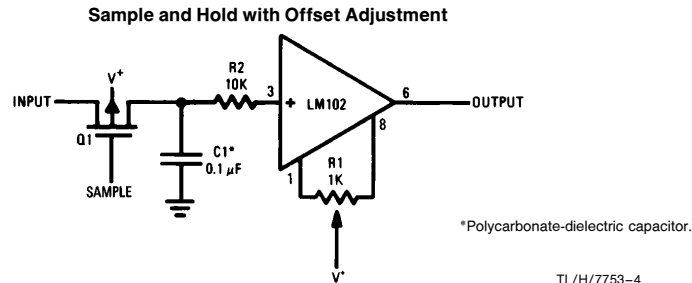

TL/H/7753-4

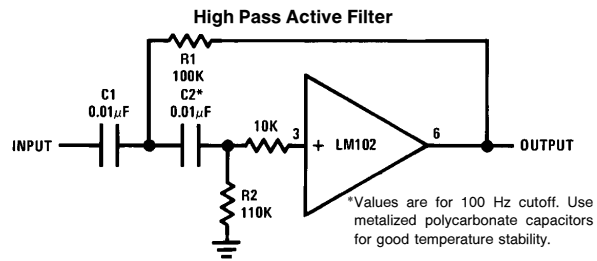

TL/H/7753-5

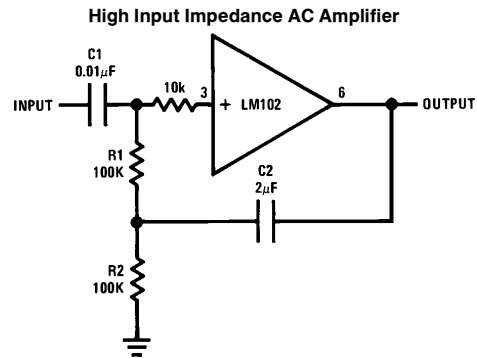

TL/H/7753-6

## Connection Diagram

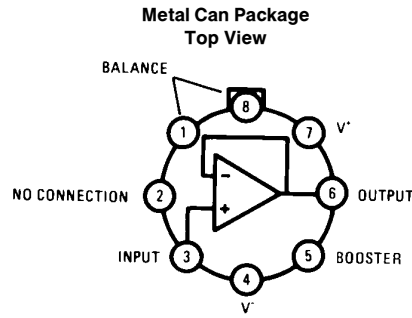

TL/H/7753-2

Order Number LM102H/883  
See NS Package Number H08C

## Physical Dimensions inches (millimeters)

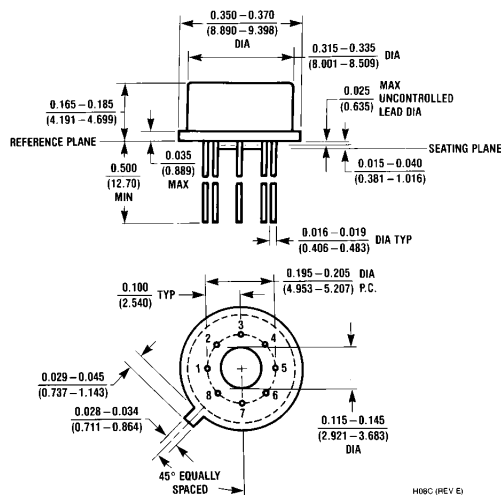

Metal Can Package (H)  
Order Number LM102H/883  
NS Package Number H08C

## LIFE SUPPORT POLICY

NATIONAL'S PRODUCTS ARE NOT AUTHORIZED FOR USE AS CRITICAL COMPONENTS IN LIFE SUPPORT DEVICES OR SYSTEMS WITHOUT THE EXPRESS WRITTEN APPROVAL OF THE PRESIDENT OF NATIONAL SEMICONDUCTOR CORPORATION. As used herein:

1. Life support devices or systems are devices or systems which, (a) are intended for surgical implant into the body, or (b) support or sustain life, and whose failure to perform, when properly used in accordance with instructions for use provided in the labeling, can be reasonably expected to result in a significant injury to the user.
2. A critical component is any component of a life support device or system whose failure to perform can be reasonably expected to cause the failure of the life support device or system, or to affect its safety or effectiveness.



**National Semiconductor Corporation**  
1111 West Bardin Road  
Arlington, TX 76017  
Tel: 1(800) 272-9959  
Fax: 1(800) 737-7018

**National Semiconductor Europe**  
Fax: (+49) 0-180-530 85 86  
Email: cnjwge@tevm2.nsc.com  
Deutsch Tel: (+49) 0-180-530 85 85  
English Tel: (+49) 0-180-532 78 32  
Français Tel: (+49) 0-180-532 93 58  
Italiano Tel: (+49) 0-180-534 16 80

**National Semiconductor Hong Kong Ltd.**  
19th Floor, Straight Block,  
Ocean Centre, 5 Canton Rd.  
Tsimshatsui, Kowloon  
Hong Kong  
Tel: (852) 2737-1600  
Fax: (852) 2736-9960

**National Semiconductor Japan Ltd.**  
Tel: 81-043-299-2309  
Fax: 81-043-299-2408