

Features

- 6-bit, 0.5 dB LSB, 31.5 dB range
- DC to 40 GHz operation
- Integrated TTL 0/+5V control
- +/- 0.5 dB typical bit error
- Low RMS phase 4.3° @ 20 GHz
- Die size: 1.55 x 0.95 x 0.1 mm
- ESD protection for all controls and bias
- 100% On-wafer DC & RF Tested

Description

The MAAD-011021 is a wide band 6-bit digital attenuator covering DC to 40 GHz. The attenuation bit-values are 0.5 dB LSB (least significant bit), 1, 2, 4, 8, and 16 dB for a total attenuation of 31.5 dB. Attenuation error is typically less than +/- 0.5 dB, RMS phase error is less than 5 degrees at 20 GHz, and typical insertion loss is 7.1 dB at 15 GHz. Return loss is typically 12 dB across all frequencies and attenuation states.

The attenuator integrates an inverter to allow a single control for series/shunt attenuation. Inverter requires a -5 V supply (V_{CC}) and 17 mA typical, logic is 0 V / +5 V.

The device is also available in a lead-free 3 mm 16-lead PQFN plastic package; order part number MAAD-011021-TR0500.

Ordering Information¹

Part Number	Package
MAAD-011021-0GPDIE	Die in Gel Pack
MAAD-011021-DIESMB	Die on Sample Board

1. All sample boards include 3 loose parts.

Functional Schematic

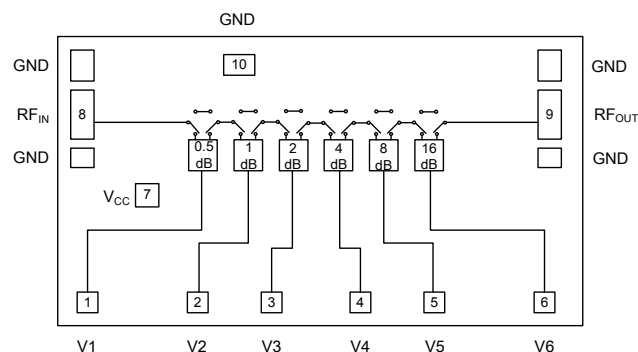

Pad Configuration

Pad No.	Pad Name	Function
1	V1	0.5 dB bit control
2	V2	1 dB bit control
3	V3	2 dB bit control
4	V4	4 dB bit control
5	V5	8 dB bit control
6	V6	16 dB bit control
7	V_{CC}	-5 V Bias
8	RF _{IN}	RF Input
9	RF _{OUT}	RF Output
10	GND	RF and DC Ground
11	Pad ²	Back of die

2. The pad on the backside of the die must be connected to RF, DC and thermal ground.

* Restrictions on Hazardous Substances, European Union Directive 2011/65/EU.

Electrical Specifications: $T_A = +25^\circ\text{C}$, $V_{CC} = -5\text{ V}$, $Z_0 = 50\ \Omega$ (unless otherwise specified)

Parameter	Test Conditions	Units	Min.	Typ.	Max.
Insertion Loss	DC - 20 GHz	dB	—	6.4	—
	20 - 40 GHz			8.8	—
	10 GHz			6.0	7.0
	20 GHz			7.0	8.0
	30 GHz			8.0	9.0
Return Loss	DC - 40 GHz	dB	—	15	—
Attenuation Bits	20 GHz	dB	0.3	0.4	0.5
	LSB: 0.5 dB			0.7	1.0
	Bit 2: 1 dB			1.7	1.9
	Bit 3: 2 dB			3.6	4.0
	Bit 4: 4 dB			7.0	9.0
	Bit 5: 8 dB			16.0	19.0
Attenuation Error RMS	DC - 20 GHz	dB	—	0.3	—
	20 - 40 GHz			1.2	—
Phase Error RMS	DC - 20 GHz	deg	—	2.6	—
	20 - 40 GHz			7.2	—
Input P0.1dB	DC - 40 GHz	dBm	—	24	—
Input IP3	DC - 40 GHz	dBm	—	38	—
Switching Time	DC - 40 GHz	ns	—	45	—
Control Logic	DC - 40 GHz	V	—	0/+5	—
Control Current	each control bit @ +5 V	mA	—	6	—
Supply Current	DC - 40 GHz	mA	—	17	45

Absolute Maximum Ratings^{3,4}

Parameter	Absolute Maximum
Input Power	+35 dBm
Operating Voltage	-5 V
Control Voltage	0 / +5 V
Operating Temperature	-40°C to +85°C
Storage Temperature	-65°C to +150°C

- Exceeding any one or combination of these limits may cause permanent damage to this device.
- MACOM does not recommend sustained operation near these survivability limits.

Handling Procedures

Please observe the following precautions to avoid damage:

Static Sensitivity

Gallium Arsenide Integrated Circuits are sensitive to electrostatic discharge (ESD) and can be damaged by static electricity. Proper ESD control techniques should be used when handling these Class 1A devices.

Truth Table^{5,6}

V1 0.5 dB	V2 1 dB	V3 2 dB	V4 4 dB	V5 8 dB	V6 16 dB	State
low	low	low	low	low	low	0 dB
high	low	low	low	low	low	0.5 dB
low	high	low	low	low	low	1 dB
low	low	high	low	low	low	2 dB
low	low	low	high	low	low	4 dB
low	low	low	low	high	low	8 dB
low	low	low	low	low	high	16 dB
high	high	high	high	high	high	31.5 dB

5. high = +5 V @ 5.7 mA, low = 0 V @ 1.0 mA.

6. Any combination of the above states will provide attenuation approximately equal to the sum of the bits selected.

Die Layout

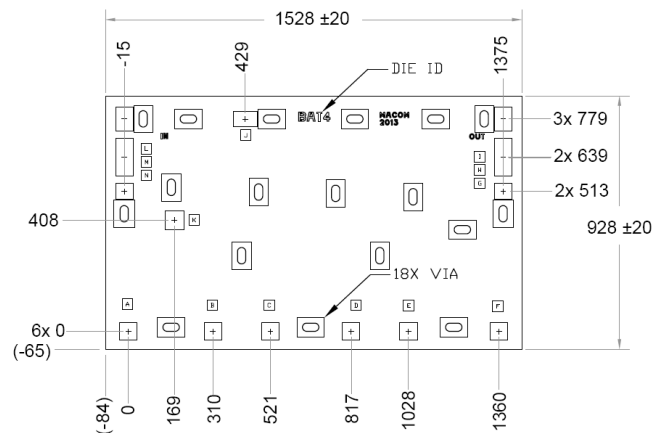

Notes:

1. All units are in μm , unless otherwise noted, with a tolerance of $\pm 5 \mu\text{m}$.
2. Die thickness is $100 \pm 10 \mu\text{m}$.

Bond Pad Opening Detail

Pad	Size (x) μm	Size (y) μm
A - F	64	64
G, N	64	59
H, M	64	139
I, L	64	87
J	89	57
K	69	69

Typical Performance Curves

Insertion Loss

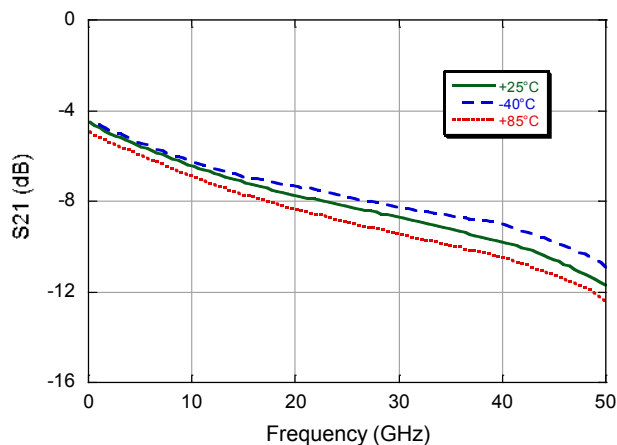

P0.1dB Compression

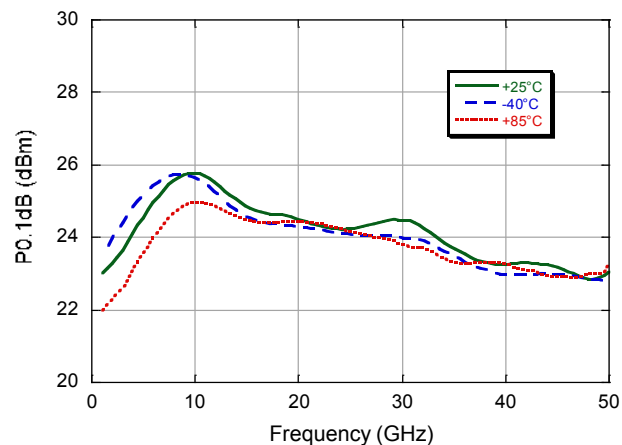

Maximum Input Return Loss (all states)

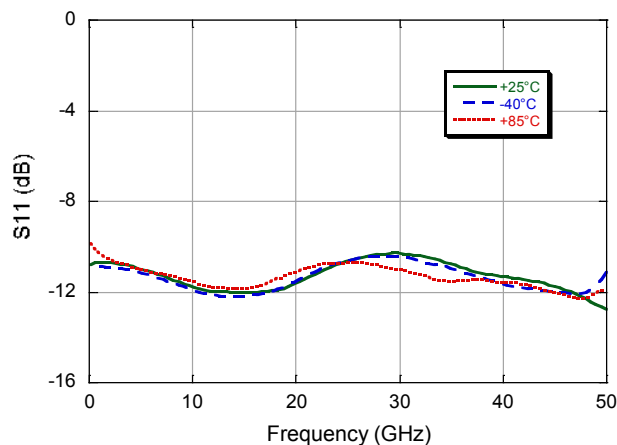

Maximum Output Return Loss (all states)

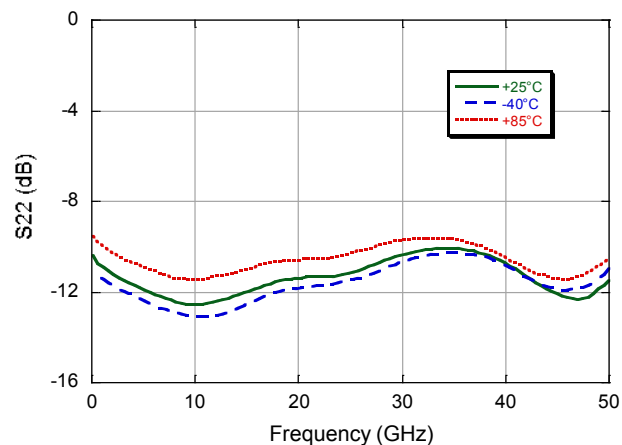

Input IP3 (reference states)

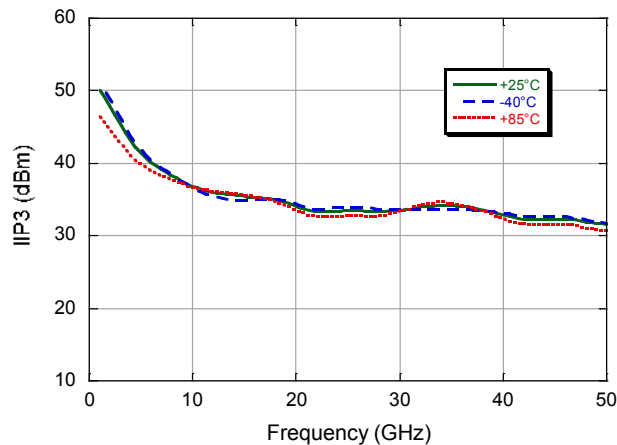

Noise Figure (reference states)

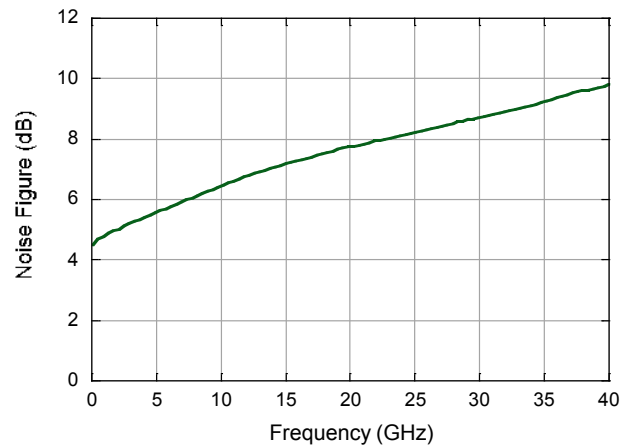

Typical Performance Curves

Attenuation

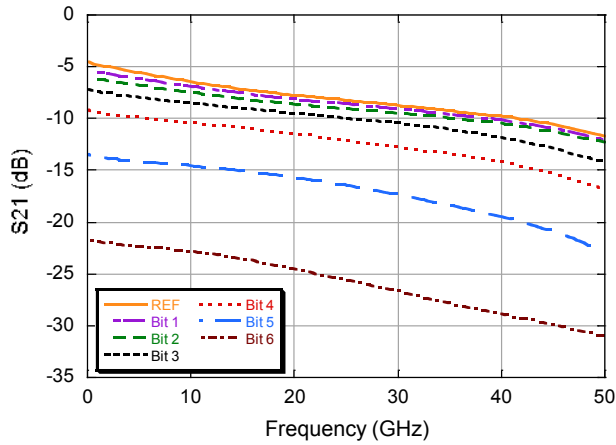

Relative Attenuation

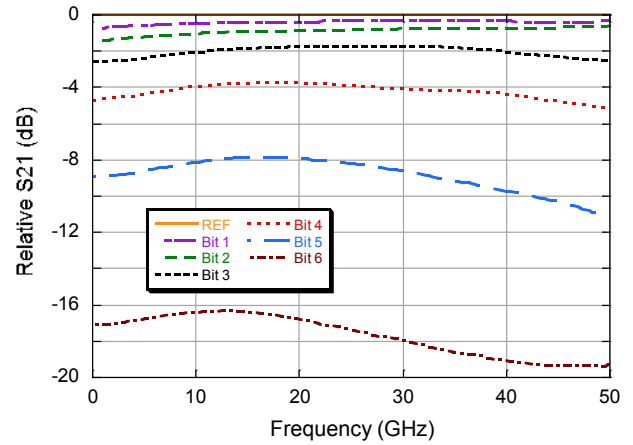

RMS Attenuation Error

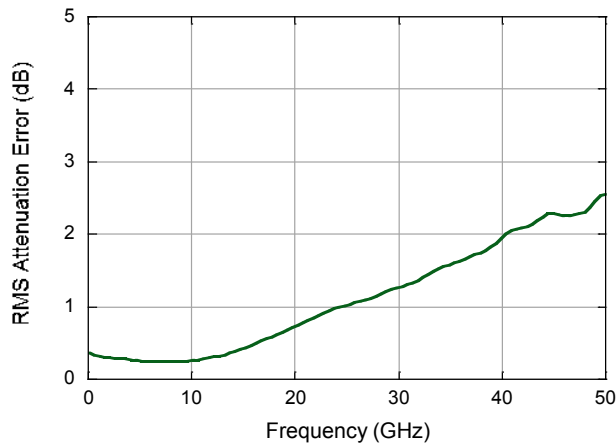

RMS Phase Error

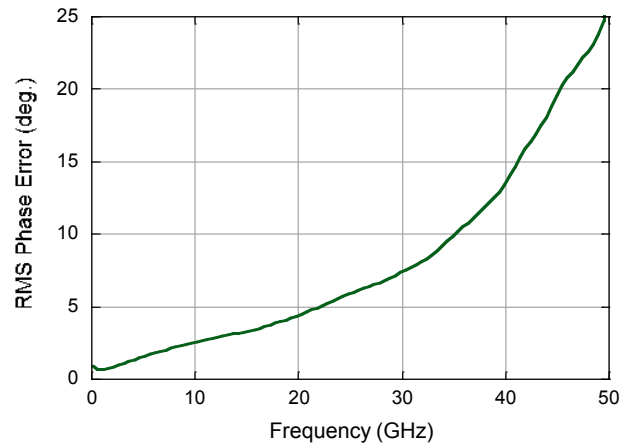

Relative Attenuation Error

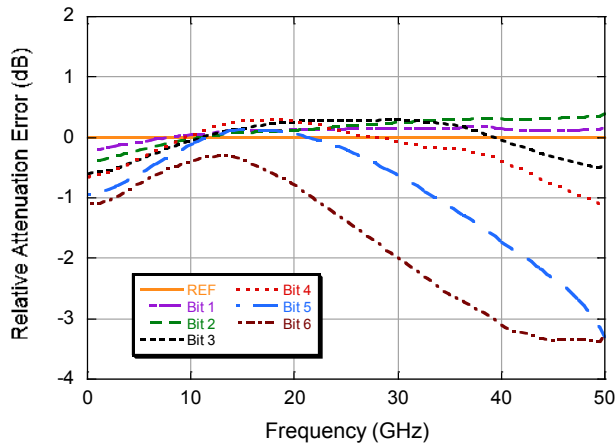

Relative Phase Error

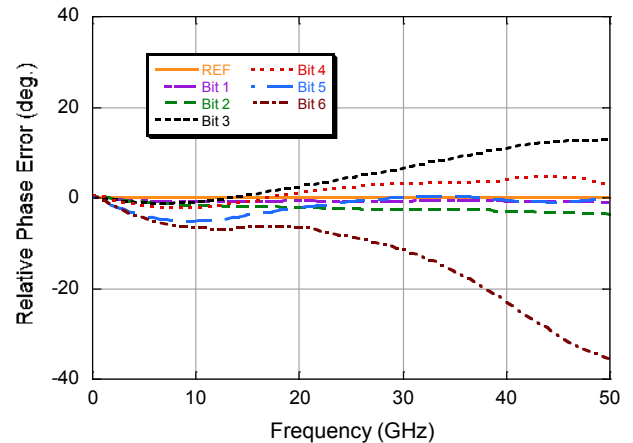

Typical Performance Curves

Relative Attenuation Error (Bit 1, 2)

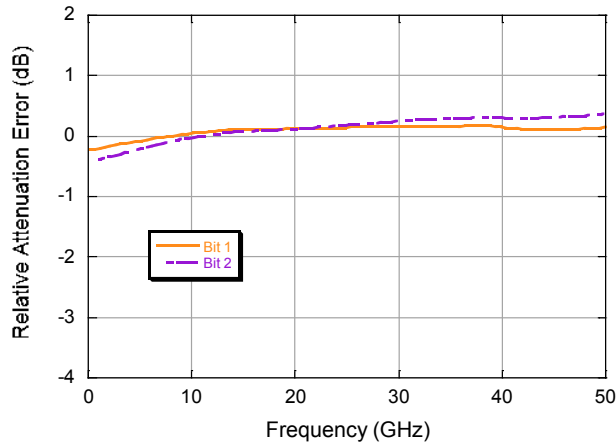

Relative Phase Error (Bit 1, 2)

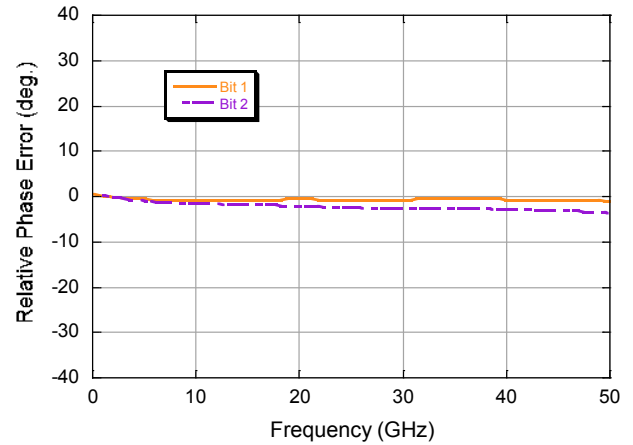

Relative Attenuation Error (Bit 3, 4)

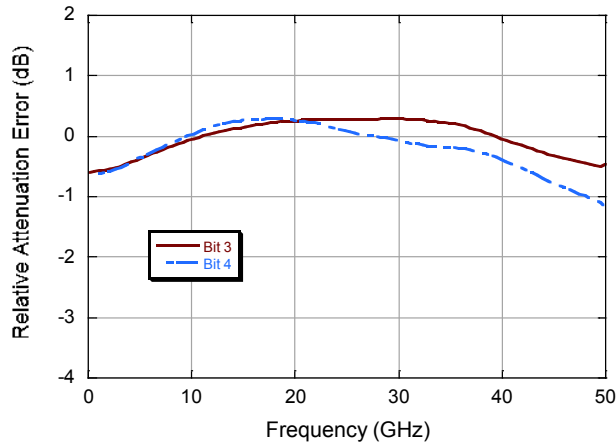

Relative Phase Error (Bit 3, 4)

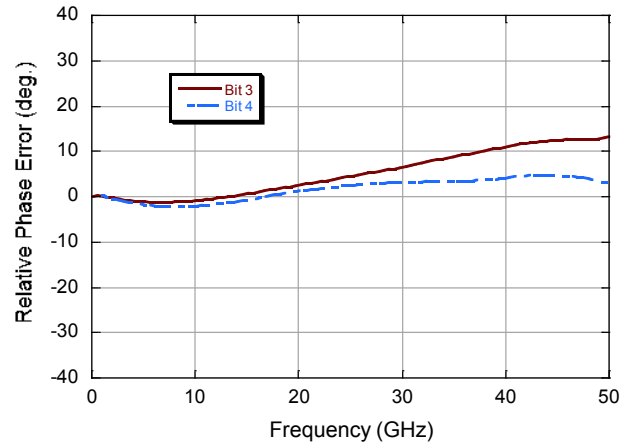

Relative Attenuation Error (Bit 5, 6)

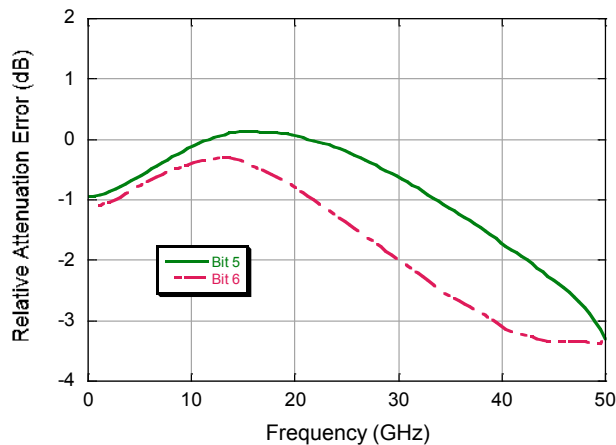

Relative Phase Error (Bit 5, 6)

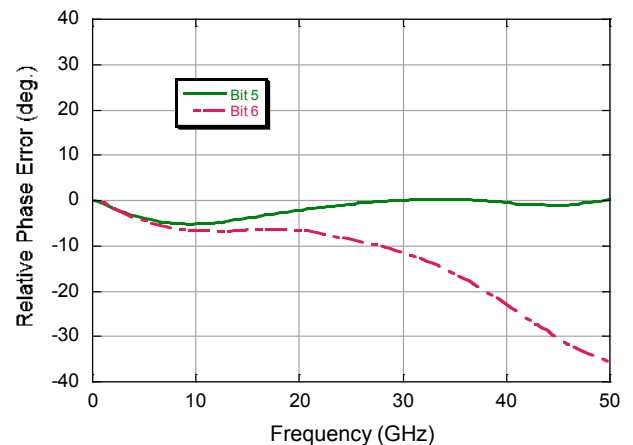

Typical Performance Curves

Step Error Between Successive States

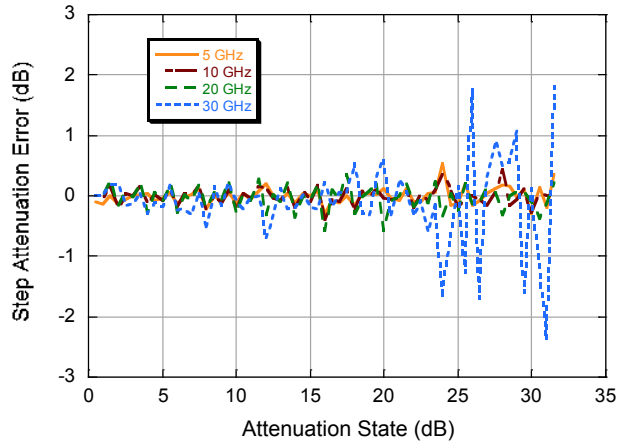

Switching Time

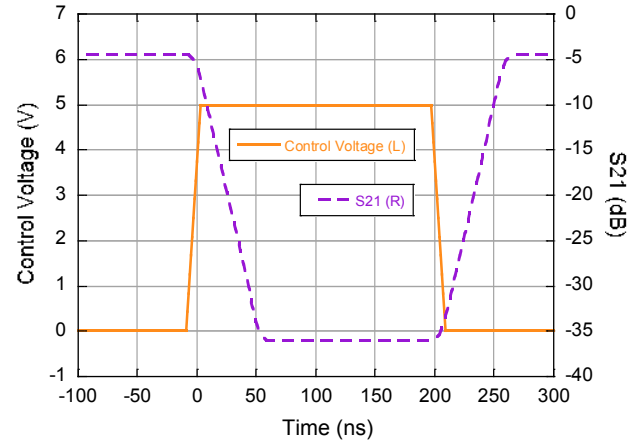

Phase Error over Attenuation States

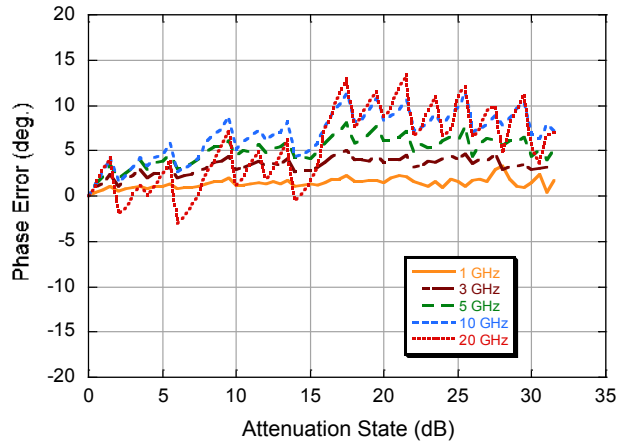

Applications Section

Application Information

The MAAD-011021 is designed for extremely wide band and robust attenuation applications. It uses a combination of series and shunt cold channel, multiple-gate FETs to achieve high linearity and accurate attenuation repeatability. We recommend using double bonds at both RF input and output, as well as keeping bondwires as short as possible to ensure higher frequency operation. This part is the most accurate for X-band applications.

The MAAD-011021 has a built in inverter function which allows a single +5 V / 0 V single control for each bit. This is useful if you require very fast switching times and have +5 V / 0 V available.

The MAAD-011021 is DC-coupled at both RF_{IN} and RF_{OUT} . If operation at DC is desired, 0 Ω jumpers (or continuous 50 Ω RF lines) should be used in series with RF_{IN} and RF_{OUT} . Customer should take extra care to ensure that the voltage at both RF_{IN} and RF_{OUT} are 0 V; excess voltage can damage the part. If operation at DC is not required, simply use series blocking capacitors.

Mounting and Bonding Techniques

The Monolithic Circuit is designed for robust and reliable usage. The die features complete passivation on all critical areas as well as a protective BCB die coat.

The die should be attached directly to the ground plane with silver conductive epoxy for best results.

A true 50 Ω microstrip or co-planar waveguide is recommended for bringing RF to and from the die as shown in the demonstration board below. This board uses 0.200 mm (8 mils) Rogers 4350 as the top dielectric layer.

Alternatively one can mount the die directly to the ground plane and launch with microstrip substrates in either alumina or Rogers to the same level as the top of the die, allowing for shorter bond wires.

The RF input and output pads are DC coupled. Blocking capacitors are required if there is a DC potential on either port.

PCB Layout

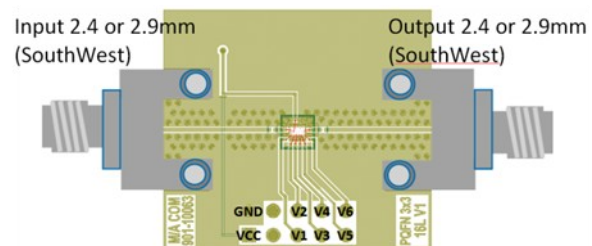
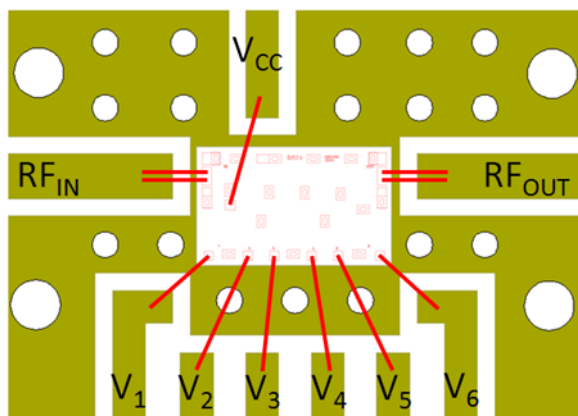

Sample board size above is 28 x 25 mm

M/A-COM Technology Solutions Inc. All rights reserved.

Information in this document is provided in connection with M/A-COM Technology Solutions Inc ("MACOM") products. These materials are provided by MACOM as a service to its customers and may be used for informational purposes only. Except as provided in MACOM's Terms and Conditions of Sale for such products or in any separate agreement related to this document, MACOM assumes no liability whatsoever. MACOM assumes no responsibility for errors or omissions in these materials. MACOM may make changes to specifications and product descriptions at any time, without notice. MACOM makes no commitment to update the information and shall have no responsibility whatsoever for conflicts or incompatibilities arising from future changes to its specifications and product descriptions. No license, express or implied, by estoppel or otherwise, to any intellectual property rights is granted by this document.

THESE MATERIALS ARE PROVIDED "AS IS" WITHOUT WARRANTY OF ANY KIND, EITHER EXPRESS OR IMPLIED, RELATING TO SALE AND/OR USE OF MACOM PRODUCTS INCLUDING LIABILITY OR WARRANTIES RELATING TO FITNESS FOR A PARTICULAR PURPOSE, CONSEQUENTIAL OR INCIDENTAL DAMAGES, MERCHANTABILITY, OR INFRINGEMENT OF ANY PATENT, COPYRIGHT OR OTHER INTELLECTUAL PROPERTY RIGHT. MACOM FURTHER DOES NOT WARRANT THE ACCURACY OR COMPLETENESS OF THE INFORMATION, TEXT, GRAPHICS OR OTHER ITEMS CONTAINED WITHIN THESE MATERIALS. MACOM SHALL NOT BE LIABLE FOR ANY SPECIAL, INDIRECT, INCIDENTAL, OR CONSEQUENTIAL DAMAGES, INCLUDING WITHOUT LIMITATION, LOST REVENUES OR LOST PROFITS, WHICH MAY RESULT FROM THE USE OF THESE MATERIALS.

MACOM products are not intended for use in medical, lifesaving or life sustaining applications. MACOM customers using or selling MACOM products for use in such applications do so at their own risk and agree to fully indemnify MACOM for any damages resulting from such improper use or sale.