

### LAMP EALP05RDEWA7

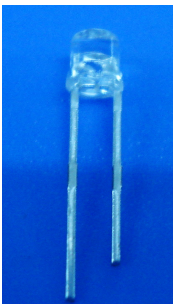

#### Features

- Popular 3mm package
- High luminous power
- Typical chromaticity coordinates  $x=0.29$ ,  $y=0.29$  according to CIE1931
- Bulk, available taped on reel.
- The product itself will remain within RoHS compliant version

#### Description

- The series is designed for application required high luminous intensity.
- The phosphor filled in the reflector converts the blue emission of InGaN chip to ideal white.

#### Applications

- Message panels
- Optical Indicators
- Backlighting
- Marker Lights

### Device Selection Guide

Chip Materials	Emitted Color	Resin Color
InGaN	White	Water clear

### Absolute Maximum Ratings (Ta=25°C)

Parameter	Symbol	Rating	Unit
Continuous Forward Current	IF	30	mA
Peak Forward Current (Duty 1/10 @ 1KHZ)	IFP	100	mA
Reverse Voltage	VR	5	V
Power Dissipation	Pd	100	mW
Operating Temperature	T <sub>opr</sub>	-40 ~ +85	°C
Storage Temperature	T <sub>stg</sub>	-40 ~ +100	°C
Soldering Temperature	T <sub>sol</sub>	260 °C for 5 sec.	

### Electro-Optical Characteristics (Ta=25°C)

Parameter	Symbol	Min.	Typ.	Max.	Unit	Condition
Forward Voltage	VF	2.8	-----	3.8	V	IF=20mA
Reverse Current	IR	-----	-----	50	uA	VR=5V
Luminous Intensity	IV	285	----	900	mcd	IF=20mA
Viewing Angle	2θ1/2	----	100	----	deg	IF=20mA
Chromaticity Coordinates	x	----	0.28	----	----	IF=20mA
	y	----	0.29	----	----	

### Bin Range of Luminous Intensity

Bin Code	Min.	Max.	Unit	Condition
D	285	360	mcd	IF =20mA
E	360	450		
F	450	565		
G	565	715		
H	715	900		

Note:  
Tolerance of Luminous Intensity: ±10%

### Forward Voltage Combination

Bin Code	Min.	Max.	Unit	Condition
0	2.8	3.0	V	IF =20mA
1	3.0	3.2		
2	3.2	3.4		
3	3.4	3.6		
4	3.6	3.8		

Note:  
Measurement Uncertainty of Forward Voltage ±0.05V

**CIE Chromaticity Diagram**

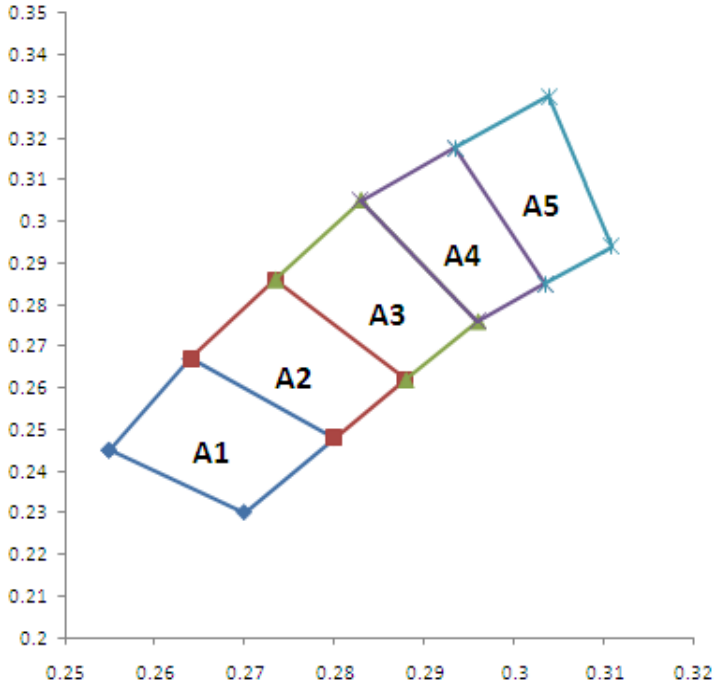

Color Ranks		CIE			
A1	X	0.255	0.264	0.28	0.27
	Y	0.245	0.267	0.248	0.23
A2	X	0.264	0.2735	0.288	0.28
	Y	0.267	0.286	0.262	0.248
A3	X	0.2735	0.283	0.296	0.288
	Y	0.286	0.305	0.276	0.262
A4	X	0.283	0.2935	0.3035	0.296
	Y	0.305	0.3175	0.285	0.276
A5	X	0.2935	0.304	0.311	0.3035
	Y	0.3175	0.33	0.294	0.285

Note:  
Measurement uncertainty of the color coordinates  $\pm 0.01$

**Typical Electro-Optical Characteristics Curves**

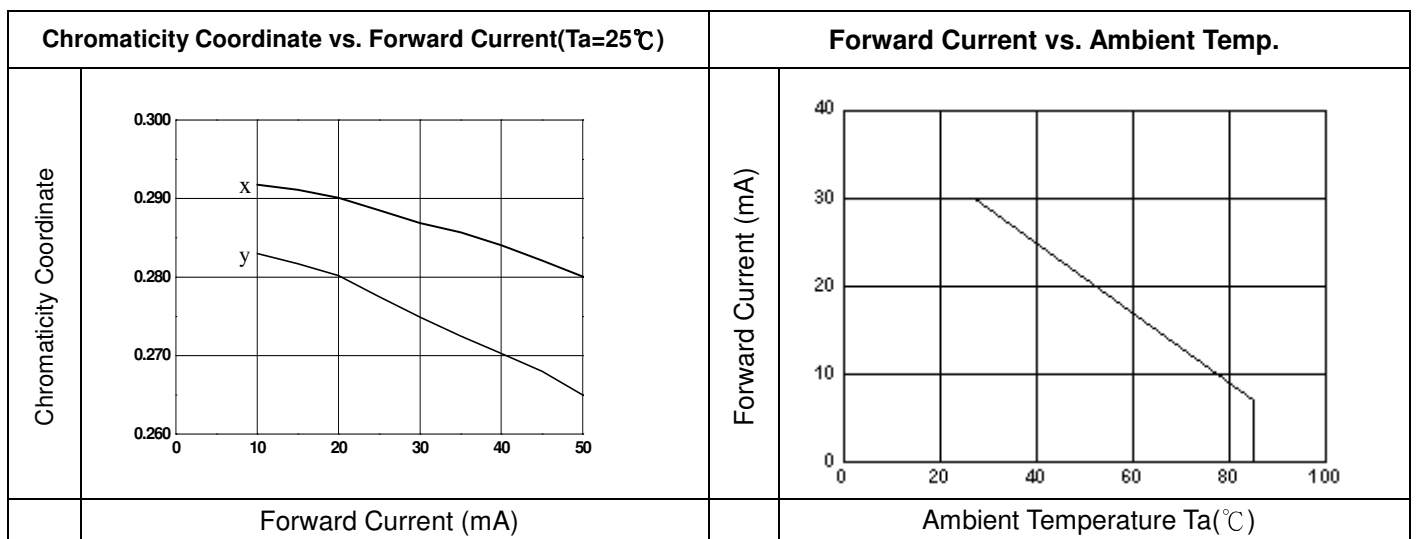
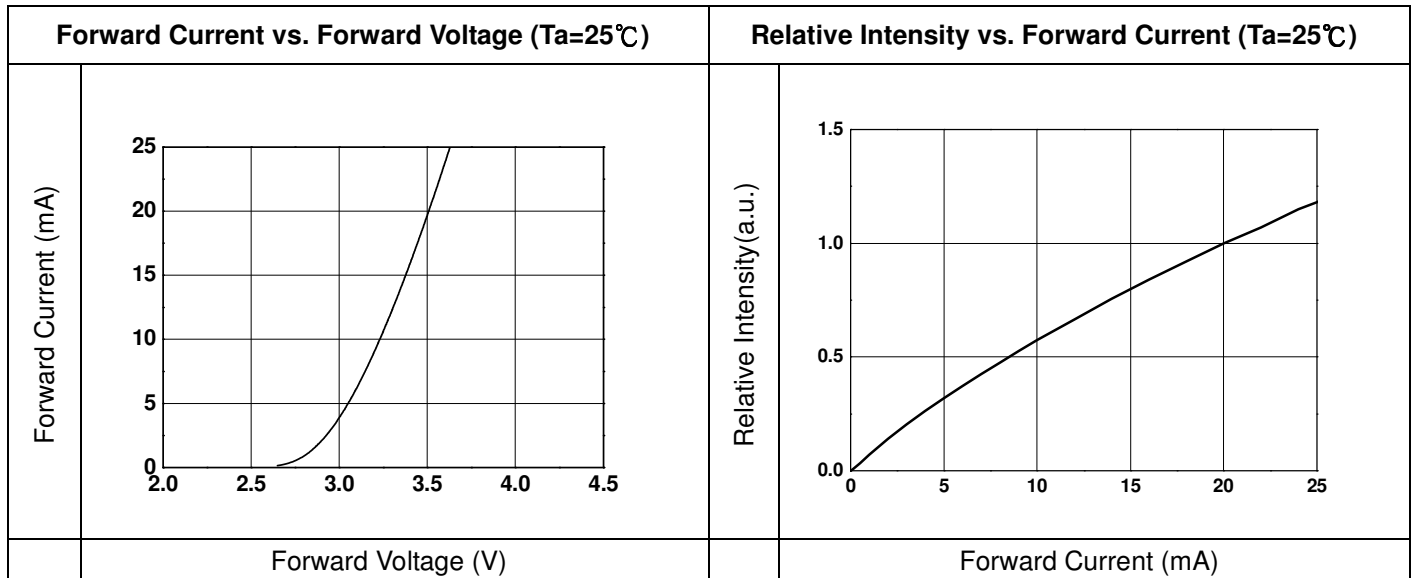
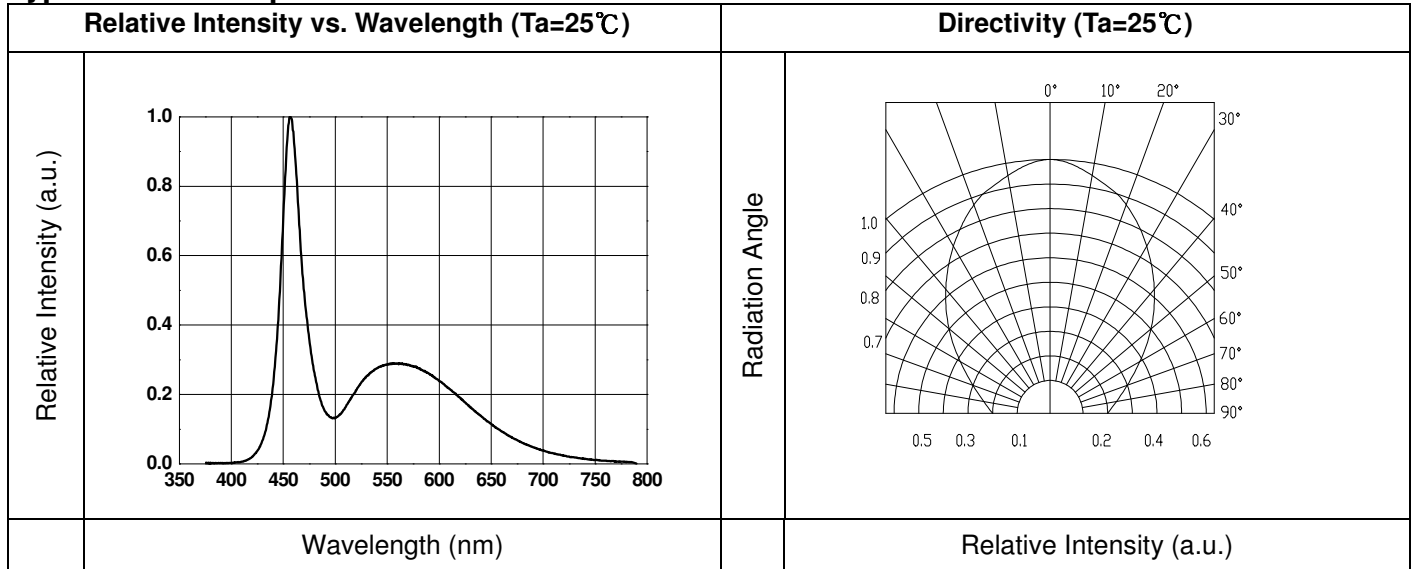

## Package Dimension

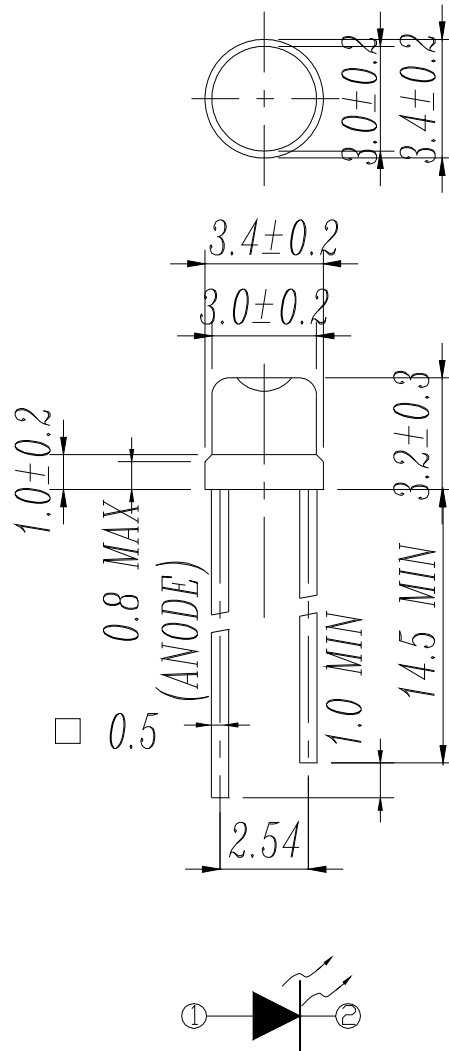

Note: Note:

- 1.All dimensions are in millimeters, and tolerance is  $\pm 0.25$ mm except being specified.
- 2.Lead spacing is measured where the lead emerges from the package.
- 3.Protruded resin under flange is 1.5mm Max. LED.

## Moisture Resistant Packing Materials

### Label Explanation

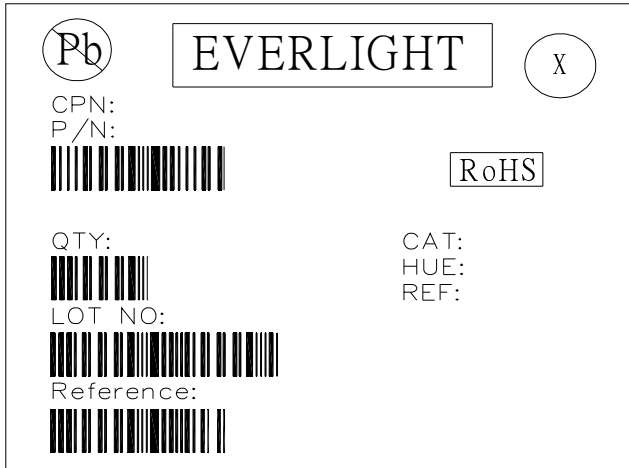

- CPN: Customer's Production Number
- P/N : Production Number
- QTY: Packing Quantity
- CAT: Ranks of Luminous Intensity and Forward Voltage
- HUE: Color Rank
- REF: Combined code
- LOT No: Lot Number

### Packing Specification

#### ■ Anti-electrostatic bag

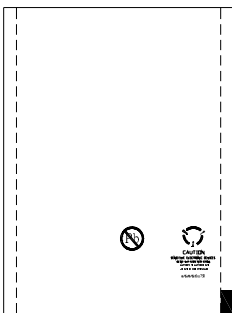

#### ■ Inner Carton

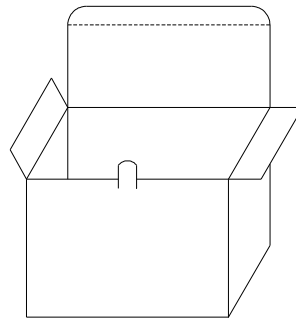

#### ■ Outside Carton

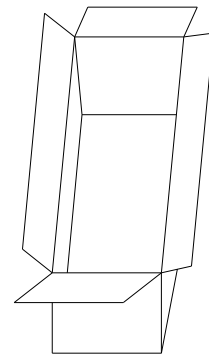

#### ■ Packing Quantity

1. 1000 PCS/1 Bag, 4Bags/1 Inner Carton
2. 10 Inner Cartons/1 Outside Carton

**Notes**

1. Lead Forming

- During lead formation, the leads should be bent at a point at least 3mm from the base of the epoxy bulb.
- Lead forming should be done before soldering.
- Avoid stressing the LED package during leads forming. The stress to the base may damage the LED's characteristics or it may break the LEDs.
- Cut the LED leadframes at room temperature. Cutting the leadframes at high temperatures may cause failure of the LEDs.
- When mounting the LEDs onto a PCB, the PCB holes must be aligned exactly with the lead position of the LED. If the LEDs are mounted with stress at the leads, it causes deterioration of the epoxy resin and this will degrade the LEDs.

2. Storage

- The LEDs should be stored at 30°C or less and 70%RH or less after being shipped from Everlight Americas and the storage life limits are 3 months. If the LEDs are stored for 3 months or more, they can be stored for a year in a sealed container with a nitrogen atmosphere and moisture absorbent material.
- Please avoid rapid transitions in ambient temperature, especially, in high humidity environments where condensation can occur.

3. Soldering

- Careful attention should be paid during soldering. When soldering, leave more than 3mm from solder joint to epoxy bulb, and soldering beyond the base of the tie bar is recommended.
- Recommended soldering conditions:

Hand Soldering		DIP Soldering	
Temp. at tip of iron	300°C Max. (30W Max.)	Preheat temp.	100°C Max. (60 sec Max.)
Soldering time	3 sec Max.	Bath temp. & time	260 Max., 5 sec Max
Distance	3mm Min.(From solder joint to epoxy bulb)	Distance	3mm Min. (From solder joint to epoxy bulb)

■ Recommended soldering profile

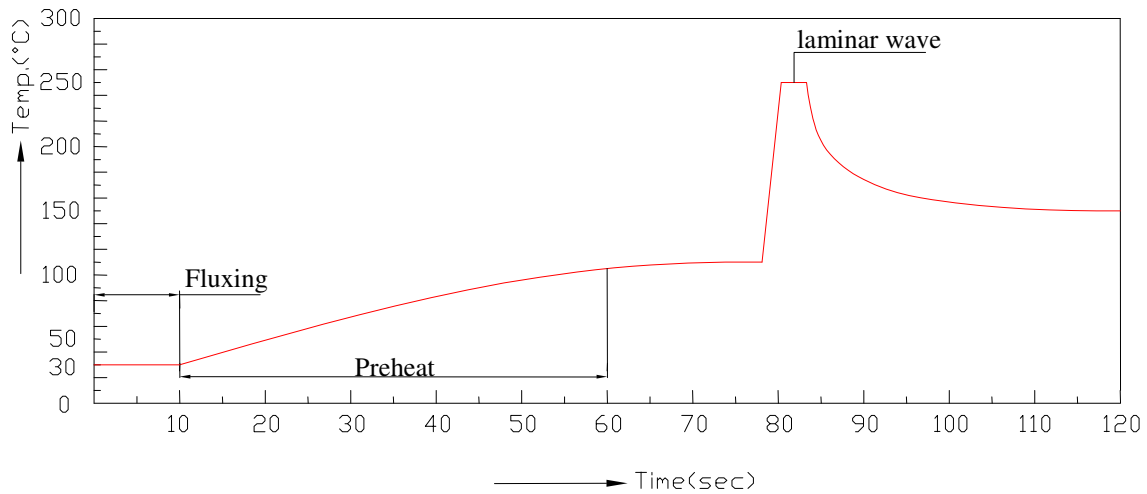

- Avoiding applying any stress to the lead frame while the LEDs are at high temperature particularly when soldering.
- Dip and hand soldering should not be done more than one time
- After soldering the LEDs, the epoxy bulb should be protected from mechanical shock or vibration until the LEDs return to room temperature.
- A rapid-rate process is not recommended for cooling the LEDs down from the peak temperature.
- Although the recommended soldering conditions are specified in the above table, dip or handsoldering at the lowest possible temperature is desirable for the LEDs.
- Wave soldering parameter must be set and maintain according to recommended temperature and dwell time in the solder wave.

4. Cleaning

- When necessary, cleaning should occur only with isopropyl alcohol at room temperature for a duration of no more than one minute. Dry at room temperature before use.
- Do not clean the LEDs by the ultrasonic. When it is absolutely necessary, the influence of ultrasonic cleaning on the LEDs depends on factors such as ultrasonic power and the assembled condition. Ultrasonic cleaning shall be pre-qualified to ensure this will not cause damage to the LED

5. Heat Management

- Heat management of LEDs must be taken into consideration during the design stage of

LED application. The current should be de-rated appropriately by referring to the de-rating curve found in each product specification.

- The temperature surrounding the LED in the application should be controlled. Please refer to the data sheet de-rating curve.

6. ESD (Electrostatic Discharge)

- The products are sensitive to static electricity or surge voltage. ESD can damage a die and its reliability.

When handling the products, the following measures against electrostatic discharge are strongly recommended:

Eliminating the charge

Grounded wrist strap, ESD footwear, clothes, and floors

Grounded workstation equipment and tools

ESD table/shelf mat made of conductive materials

- Proper grounding is required for all devices, equipment, and machinery used in product assembly.

Surge protection should be considered when designing of commercial products.

- If tools or equipment contain insulating materials such as glass or plastic, the following measures against electrostatic discharge are strongly recommended:

Dissipating static charge with conductive materials

Preventing charge generation with moisture

Neutralizing the charge with ionizers

7. Directions for use

- The LEDs should be operated with forward bias. The driving circuit must be designed so that the LEDs are not subjected to forward or reverse voltage while it is off. If reverse voltage is continuously applied to the LEDs, it may cause migration resulting in LED damage.

8. Other

- Above specification may be changed without notice. Everlight Americas will reserve authority on material change for above specification.
- When using this product, please observe the absolute maximum ratings and the instructions for using outlined in these specification sheets. Everlight Americas assumes no responsibility for any damage resulting from use of the product which does not comply with the absolute maximum ratings and the instructions included in these specification sheets.
- These specification sheets include materials protected under copyright of Everlight

Americas Inc. Please don't reproduce or cause anyone to reproduce them without Everlight Americas's consent.