

ADSL Magnetics

Centillium



TM01365

- Designed to comply with the requirements of GR1089, UL1950, EN60950, BABT and CSA950 to provide a supplementary insulation barrier with a working voltage of 250V
- Minimum interwinding breakdown voltage of 1500 Vrms
- Operating and storage temperature range: -40° to +85° C
- Meets IEC 695, 2-2 flammability requirements
- PWB Process Capability: standard printed wiring board assembly techniques, total-immersion cleaning
- Reliability testing: shock, vibration, temperature cycling, temperature - humidity - bias

ELECTRICAL SPECIFICATIONS AT 25° C

Part Number	Turns Ratio ±2%	Inductance ¹ µH ±5%	Leakage Inductance µH max	DCR Ω max		Longitudinal Balance ² dB min	Insertion Loss ² dB max	Frequency Response ² dB max	Harmonic Distortion ² dB max
	Chip : Line	Line Side	Line Side	Chip Side	Line Side	20 kHz - 1.2 MHz	300 kHz	20 kHz - 1.1 MHz	30 kHz 5.3 Vrms
S560-6600-DP	1 : 1	850	6	3.64	3.30	55	1.2	±1.0	-80

All measurements are made with pins 2 and 3 connected and pins 6 and 7 connected

1. Inductance measured at 10 kHz, 0.1 Vac

2. Measurements made with 100Ω source and 100Ω load impedance

SCHEMATIC

S560-6600-DP

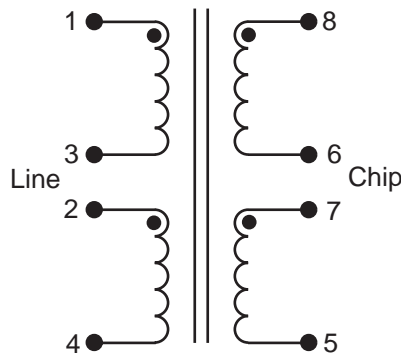

TM01365

MECHANICAL

S560-6600-DP

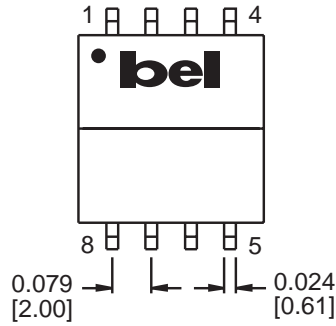

Suggested PCB Pad Layout

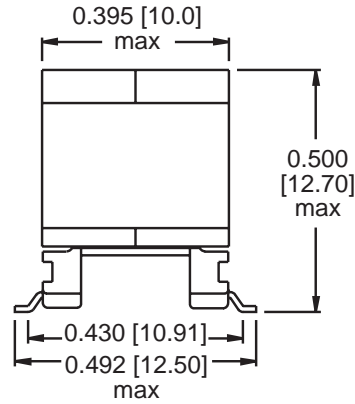
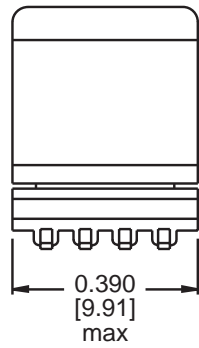
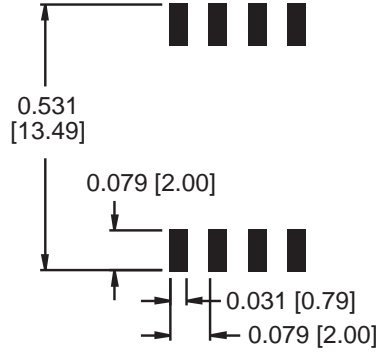

Dimensions are in inches [millimeters].
Standard dimension tolerance is ± 0.005 [0.13] unless otherwise noted.

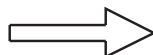
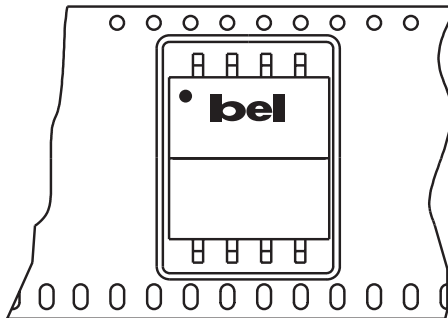

User Feed Direction

Orientation of Component Inside Pocket

Tape and Reel Packaging

24 mm wide by 20 mm pitch; 13 inch OD, 4 inch ID
200 components per reel, maximum
Meets ANSI/EIA 481-2 Carrier Tape Standards

©2001 Bel Fuse Inc. Specifications subject to change without notice. 09.01

CORPORATE

Bel Fuse Inc.
206 Van Vorst Street
Jersey City, NJ 07302
Tel 201-432-0463
Fax 201-432-9542
www.belfuse.com

FAR EAST

Bel Fuse Ltd.
8F / 8 Luk Hop Street
San Po Kong
Kowloon, Hong Kong
Tel 852-2328-5515
Fax 852-2352-3706
www.belfuse.com

EUROPE

Bel Fuse Europe Ltd.
Preston Technology Management Centre
Marsh Lane, Suite G7, Preston
Lancashire, PR1 8UD, U.K.
Tel 44-1772-556601
Fax 44-1772-888366
www.belfuse.com