

DETAILS

Product Number	FCN14648_JENNY-CY
Family	Jenny
Type	Pack
Color	black
Diameter	34,8+50 mm
Height	11,5 mm
Style	rectang
Optic Material	Silicone
Holder Material	
Fastening	screw
Status	production ready
ROHS Compliant	Yes
Date Updated	18/10/2016



OPTICAL PROPERTIES

LED	Viewing Angle	Light Beam	Efficiency	cd/lm	Connector
V6 Gen6	110+110 deg	Wide-Area...	94 %	0.350	-
V8 Gen6	105+106 deg	Wide-Area...	94 %	0.400	-
V10 Gen6	103+101 deg	Wide-Area...	94 %	0.430	-
V10 Gen7	sim: 95+102	Wide-Area...	sim: 94 %	sim: 0.390	-
CLL01x	104+104 deg	Wide-Area...	94 %	0.443	-
CLL02x/CLU02x (LES10)	103+103 deg	Wide-Area...	93 %	0.400	-
CLU700/701	102+102 deg	Wide-Area...	93 %	0.470	-
XHP50	105+105 deg	Wide-Area...	94 %	0.420	-
CXA/B 13xx	105+105 deg	Wide-Area...	94 %	0.410	-
MK-R	105 deg	Wide-Area...	92 %	0.420	-
XM-L EZW	102+103 deg	Wide-Area...	94 %	0.460	-
LUXEON 5258	103+104 deg	Wide-Area...	94 %	0.490	-
LUXEON M/MX	105 deg	Wide-Area...	94 %	0.450	-
NSMx286M	105+104 deg	Wide-Area...	94 %	0.410	-
NV4x144A	107+107 deg	Wide-Area...	92 %	0.460	-
Duris S8	102+102 deg	Wide-Area...	94 %	0.520	-
Duris S10	108 deg	Wide-Area...	94 %	0.350	-
Soleriq P6	106+107 deg	Wide-Area...	94 %	0.400	-
Soleriq P9	106+106 deg	Wide-Area...	94 %	0.390	-
Duris P10	sim: 100	Wide-Area...	sim: 93 %	sim: 0.540	-
COB D Series LES 9.8 mm	106+106 deg	Wide-Area...	94 %	0.370	-
MJT COB LES 9.8	105+105 deg	Wide-Area...	93 %	0.360	-
MJT COB LES 6	111+111 deg	Wide-Area...	91 %	0.360	-
SLE G5 LES6	108+108 deg	Wide-Area...	93 %	0.400	-
SLE G5 LES11	106+106 deg	Wide-Area...	91 %	0.350	-



PRODUCT DATASHEET

Jenny series

last update 18/10/2016

OPTICAL PROPERTIES

LED	Viewing Angle	Light Beam	Effi- ciency	cd/lm	Connector
-----	------------------	---------------	-----------------	-------	-----------

D

C

B

A

4

4

11.45

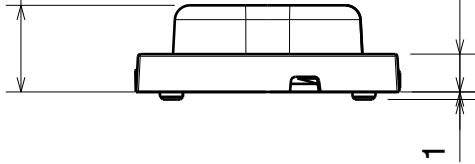

Front view

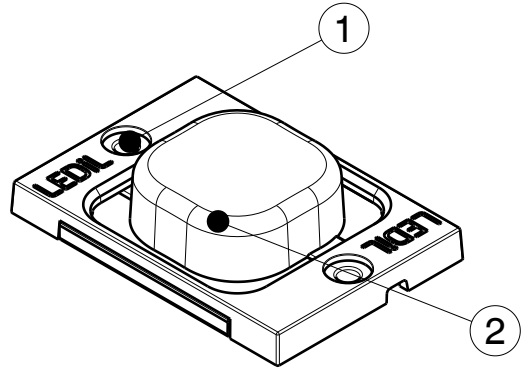

Isometric view

3

3

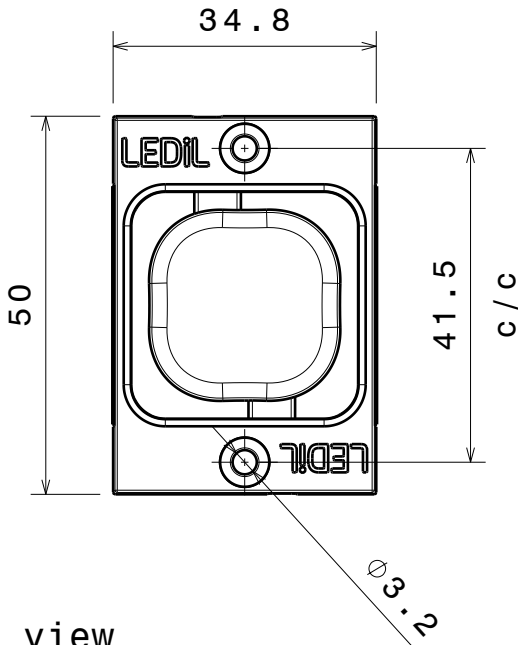

Top view

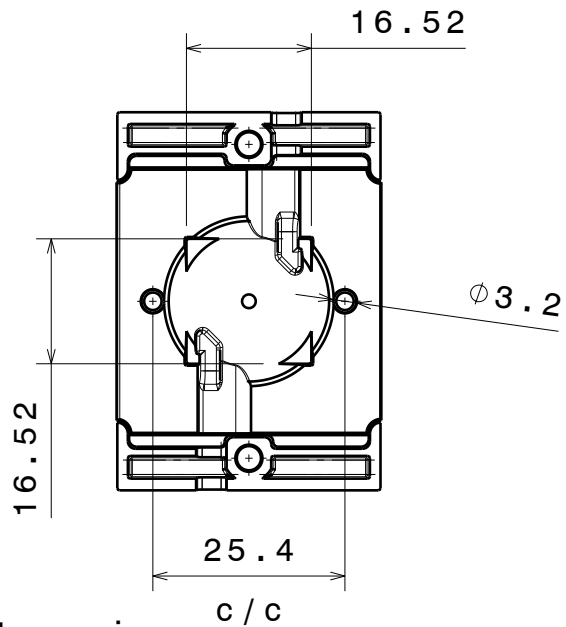

Bottom view

2

2

INDEX	PART NO	DESCRIPTION	MATERIAL	COLOUR
1	C14436	JENNY-HLD-A-BLK	PC	black
2	F14531	JENNY-CY	Optical grade LSR	clear

Tolerances if not otherwise shown
 According to DIN ISO 2768-1
 Linear measures: class V
 Please note that due to the elasticity of
 products made of silicone actual measured
 values may vary, and therefore typical
 tolerance values may not be applied.



Ledil Oy
 Salorankatu 10
 FIN 24240 SALO
 Finland

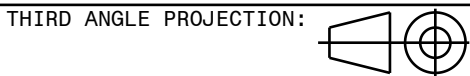

THIRD ANGLE PROJECTION:

DRAWING TITLE

FCN14648_JENNY-CY

This drawing is the property
 of LEDiL Oy. It may not be
 reproduced, copied or
 communicated without a written
 agreement with LEDiL Oy.

SIZE PART NUMBER

A4

FCN14648

SCALE 1:1 WEIGHT 9,02 g SHEET 1/1

D

A

1

1

Luminaire: LEDiL Oy FCN14648_JENNY-CY_(V6)

Lamps: 1 x BRIDGELUX_V6_447.582lm@250mA_P=5.15119W_I=249.9mA

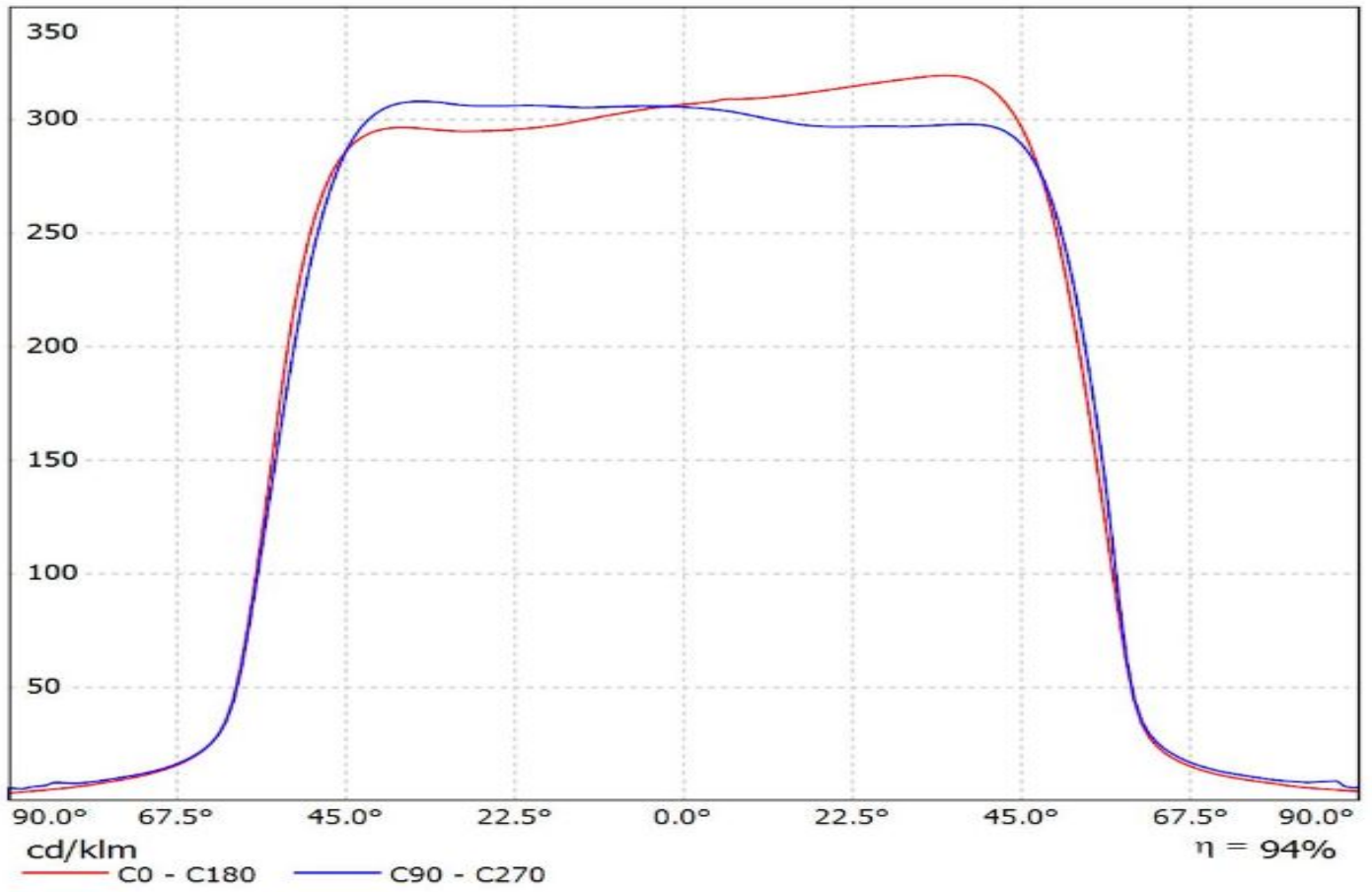

Luminaire: LEDiL Oy FCN14648_JENNY-CY_(V8)

Lamps: 1 x BRIDGELUX_V8_871.869lm@250mA_P=8.88614W_I=249.8mA

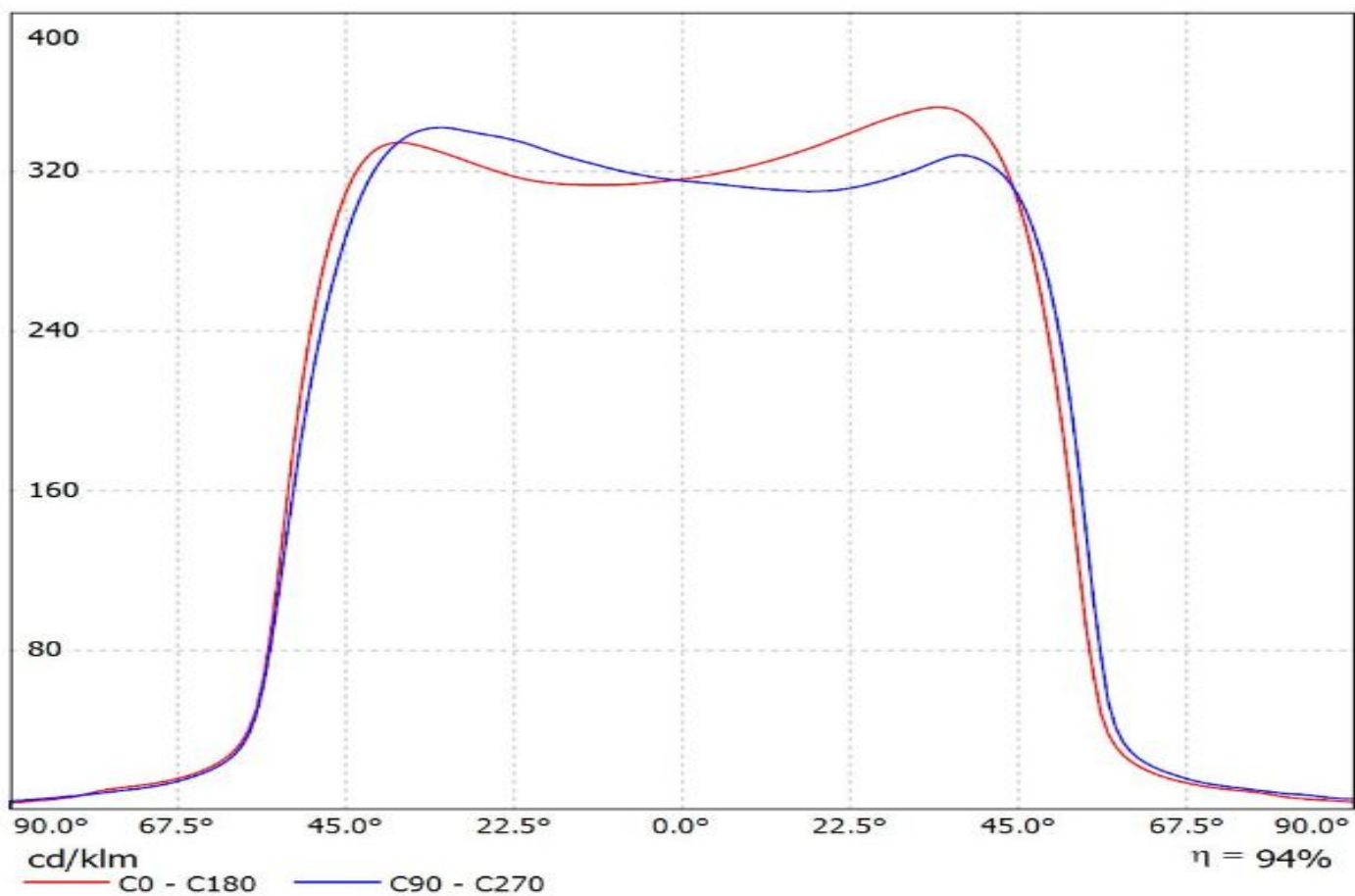

Luminaire: LEDiL Oy FCN14648_JENNY-CY_(V10)

Lamps: 1 x BRIDGELUX_V10_(BXRE-30E1000B-X2)_763.702lm@250mA_P=6.32922W_I=249.9mA

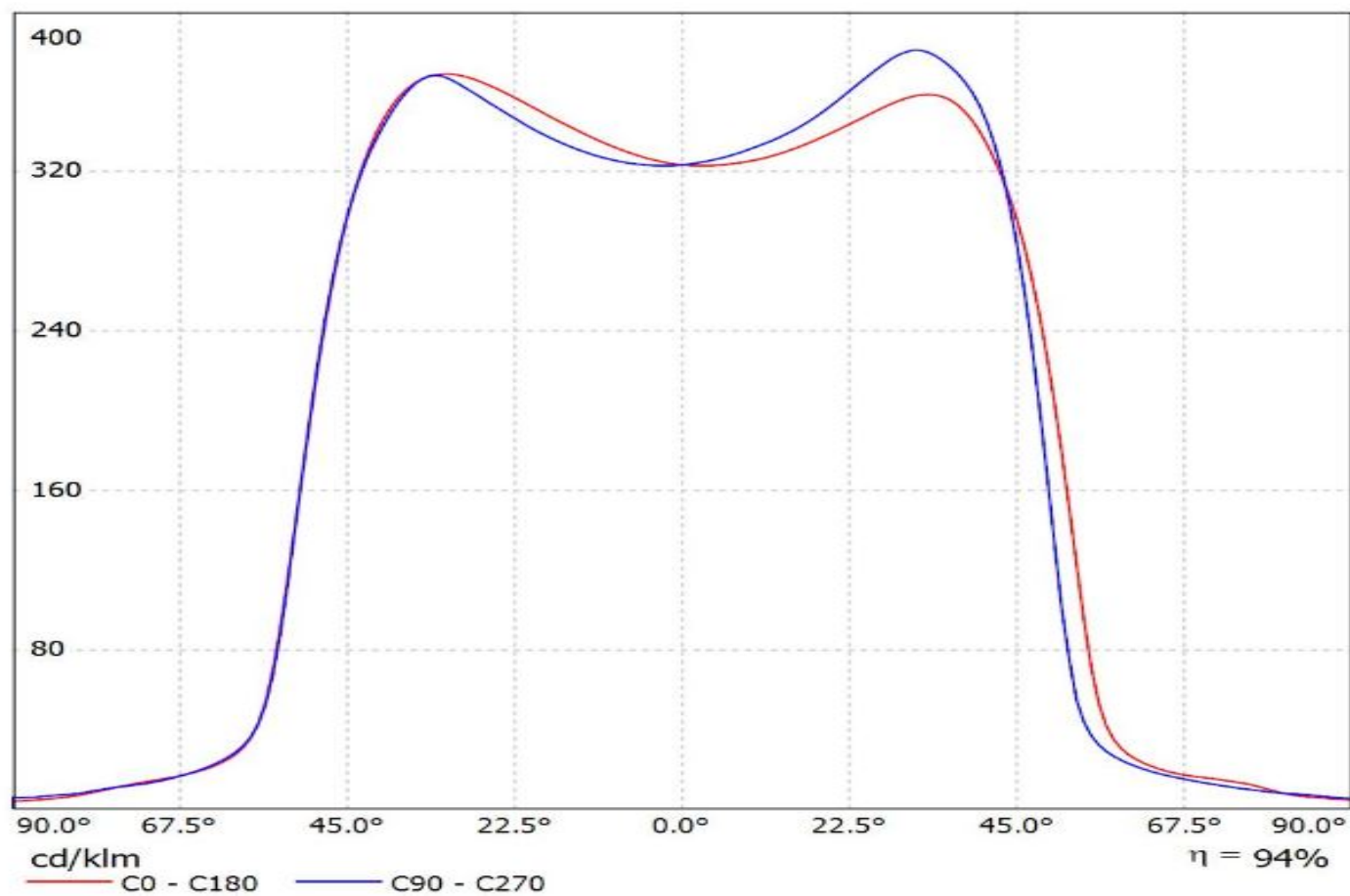

Luminaire: Ledil Oy FCN14648_JENNY-CY_BRIDGELUX_V10_Gen7_SIMULATED
Lamps: 1 x BRIDGELUX V10 Gen7

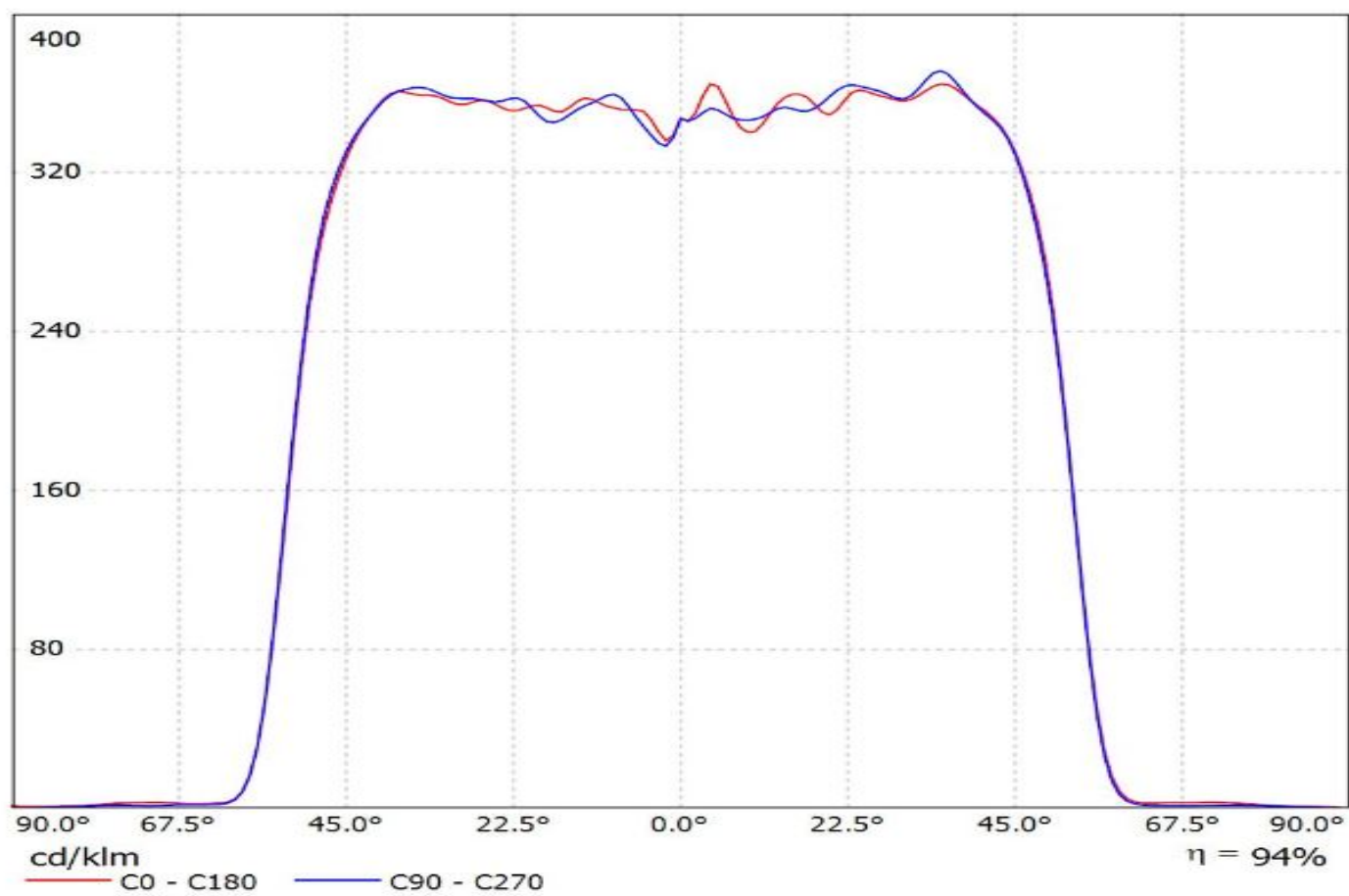

Luminaire: LEDiL Oy FCN14648_JENNY-CY_(CLL010)

Lamps: 1 x CITIZEN_CLL010_(CLL010-0305A1-303M1A2)_206.314lm@250mA_P=2.27184W_I=249.9mA

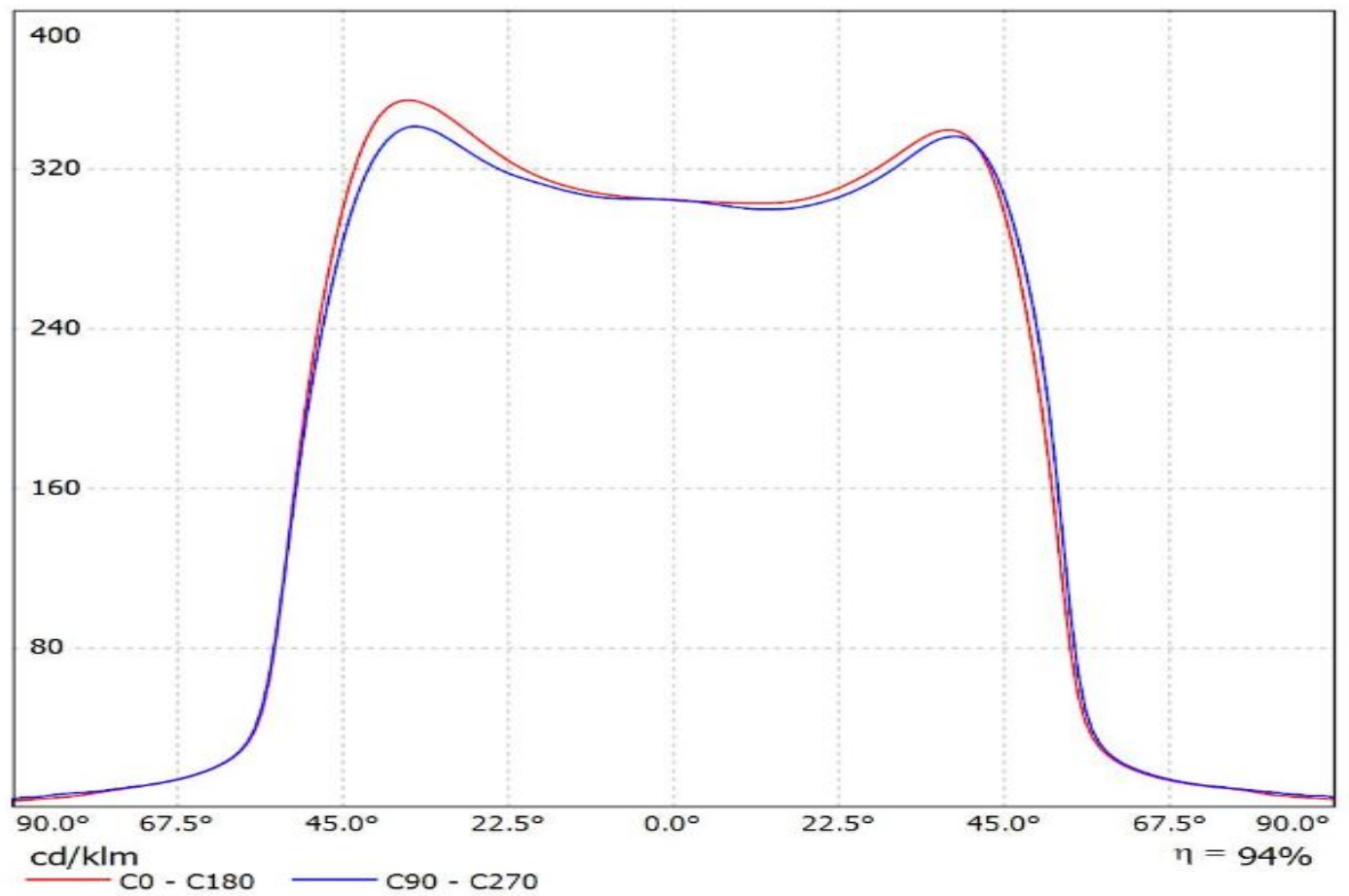

Luminaire: LEDiL Oy FCN14648_JENNY-CY_(CLL022)

Lamps: 1 x CITIZEN_CLL022_(CLL022-1204A5-030H7E1)_748.012lm@250mA_P=8.70803W_I=249.8mA

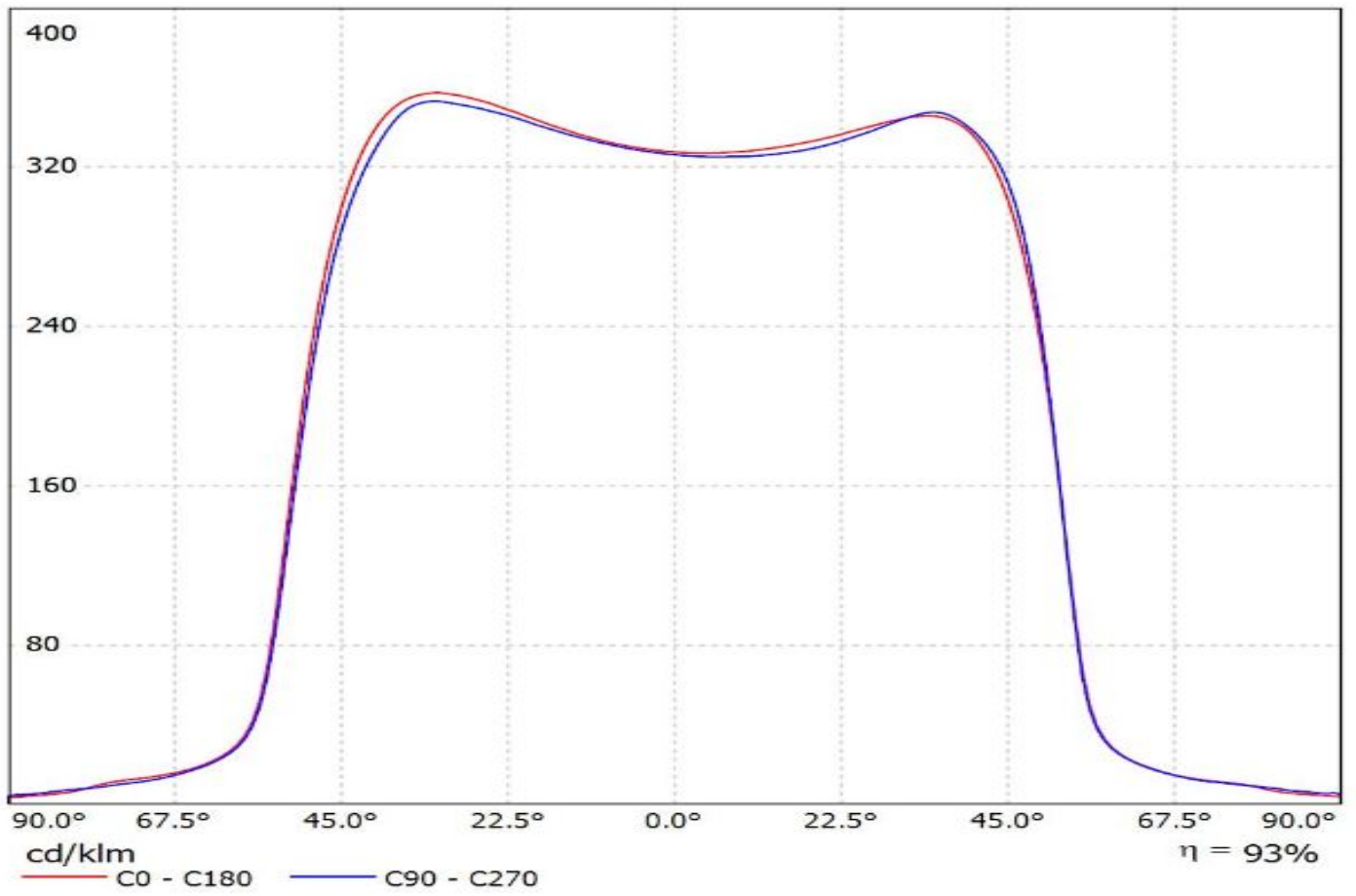

Luminaire: Ledil FCN14648_JENNY-CY_(CLU700)
Lamps: 1 x Citizen_CLU700_394.637lm@100mA_P=2.8W_I=0.10A

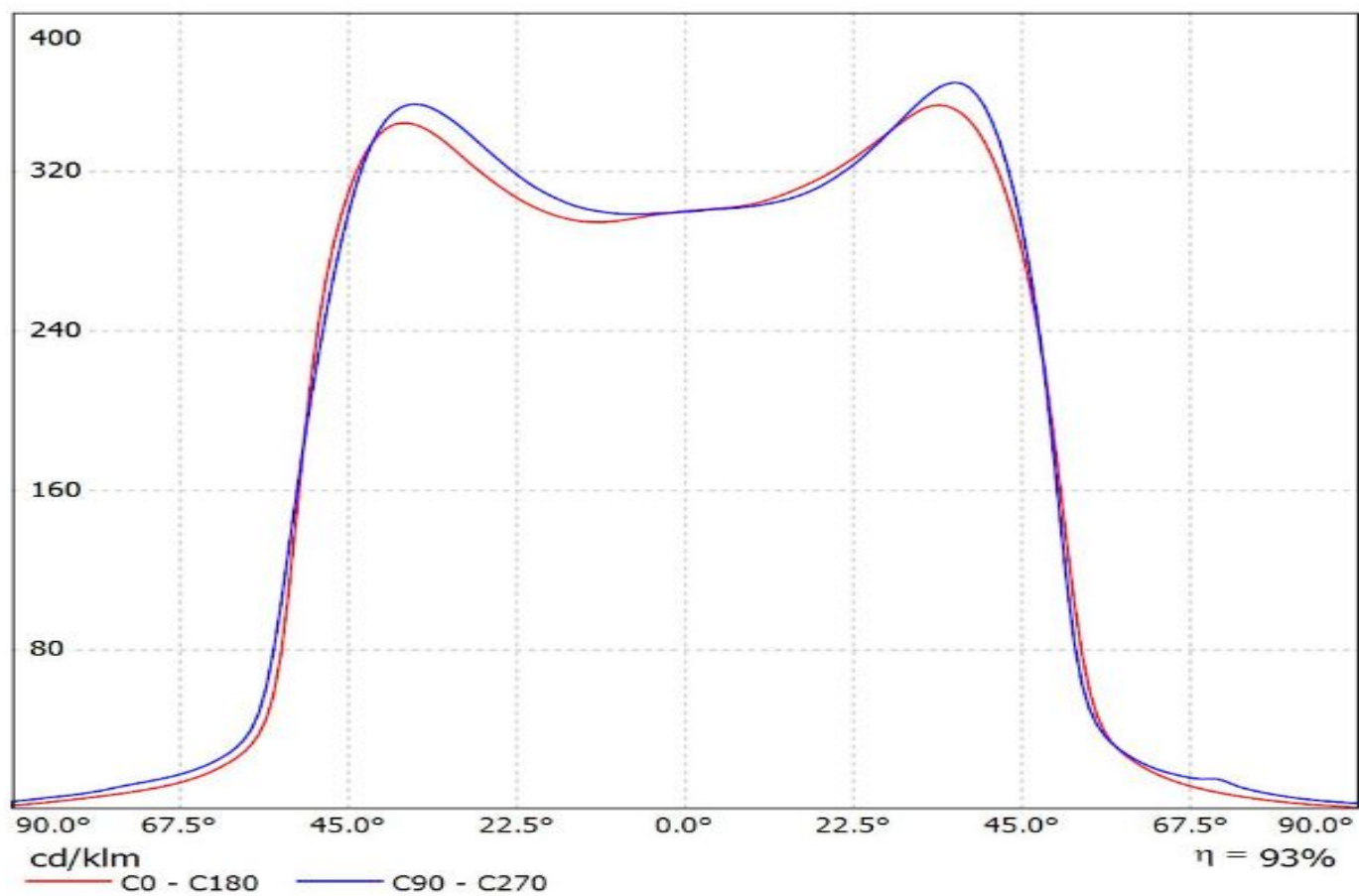

Ledil F14531_JENNY-CY_(XHP50) / LDC (Linear)

Luminaire: Ledil F14531_JENNY-CY_(XHP50)

Lamps: 1 x XHP50_warm_white_210.85lm@250mA_P=1.4W_I=0.25A

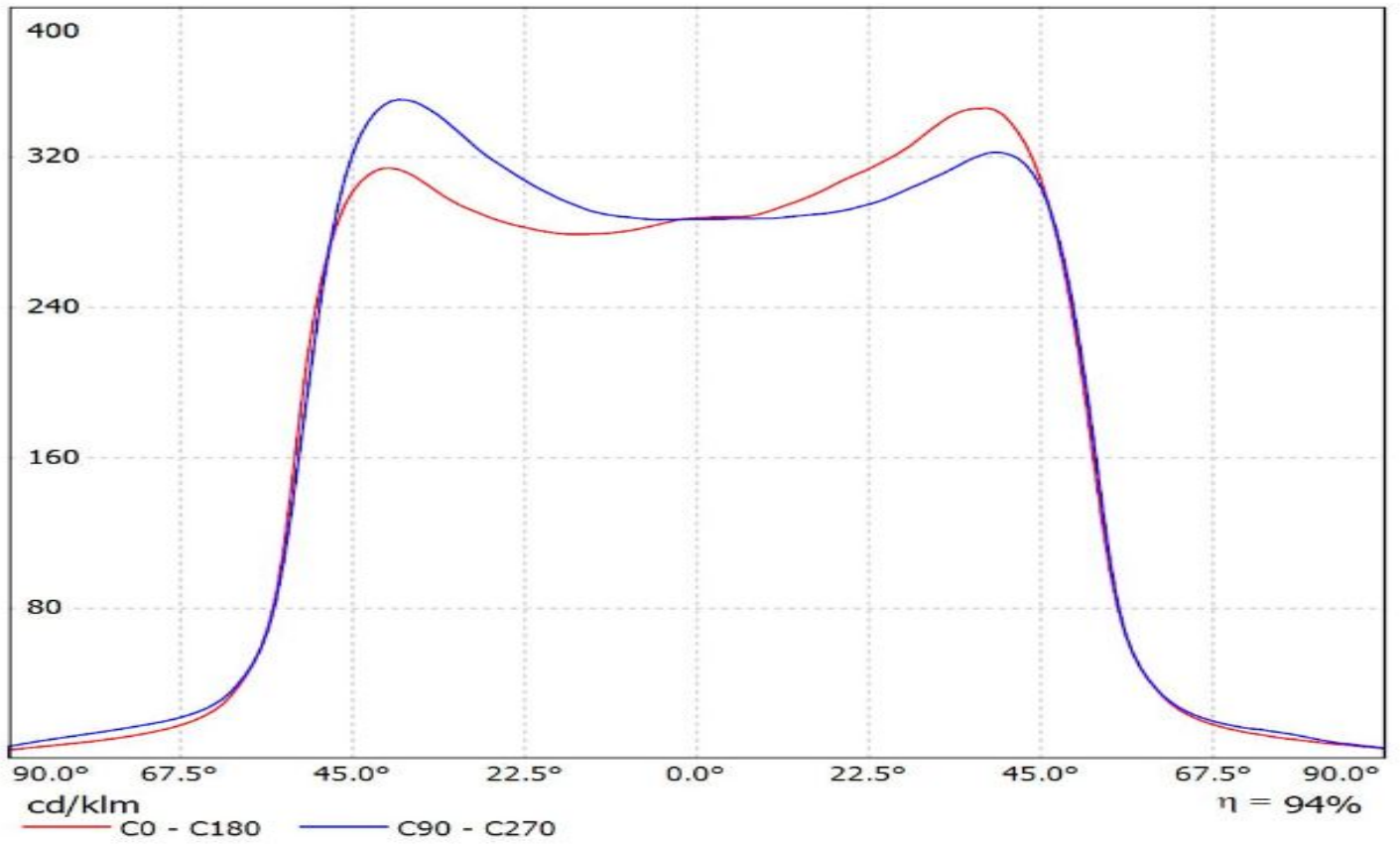

Luminaire: LEDiL Oy FCN14648_JENNY-CY_(CXA1310)

Lamps: 1 x CREE_CXA1310_(CXA1310-30H-G4-F0Y-00001)_367.9lm@250mA_CCT=3000K_P=4.22112W_I=249.8mA

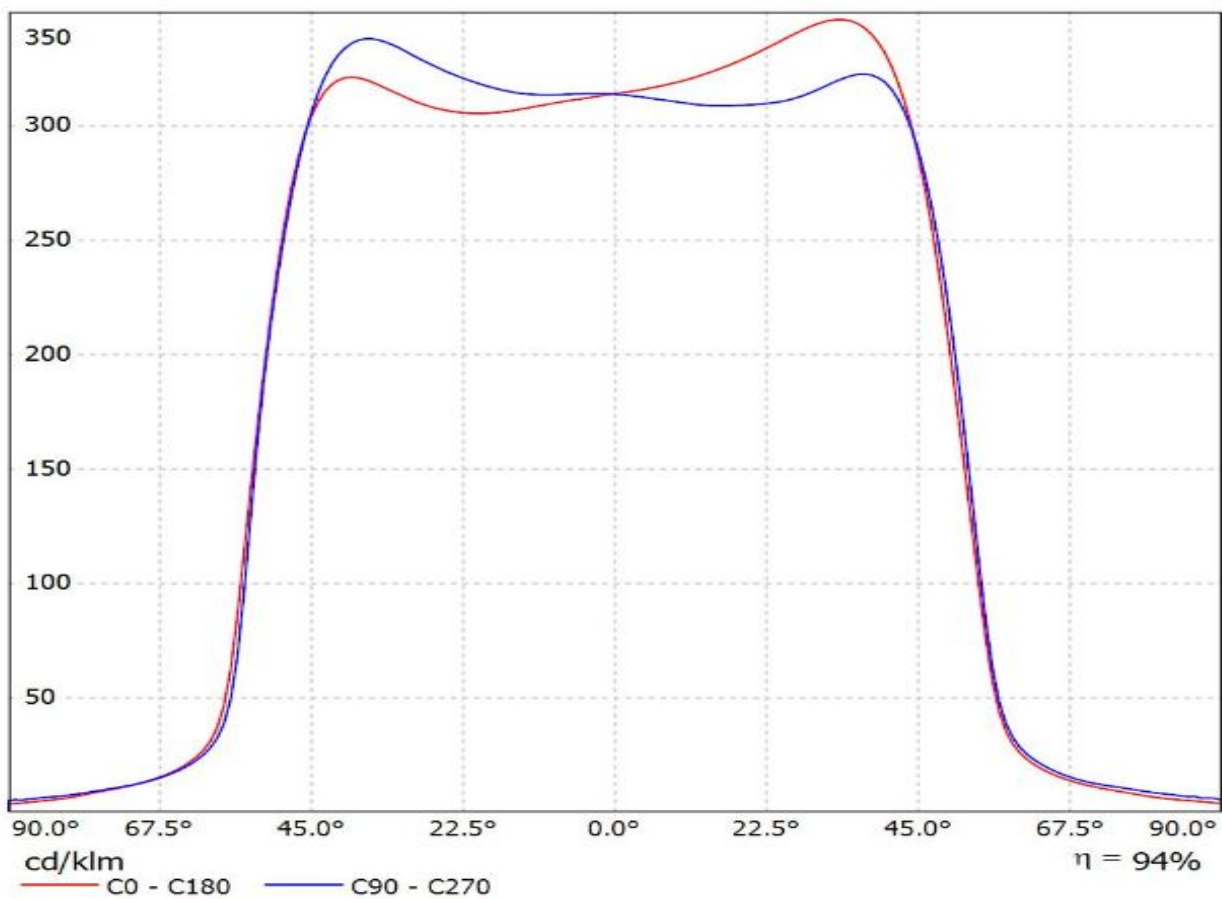

Luminaire: LEDiL Oy FCN14648_JENNY-CY_(MK-R)

Lamps: 1 x MK-R_353.258lm@250mA_CCT=3276K_P=2.84836W_I=249.9mA

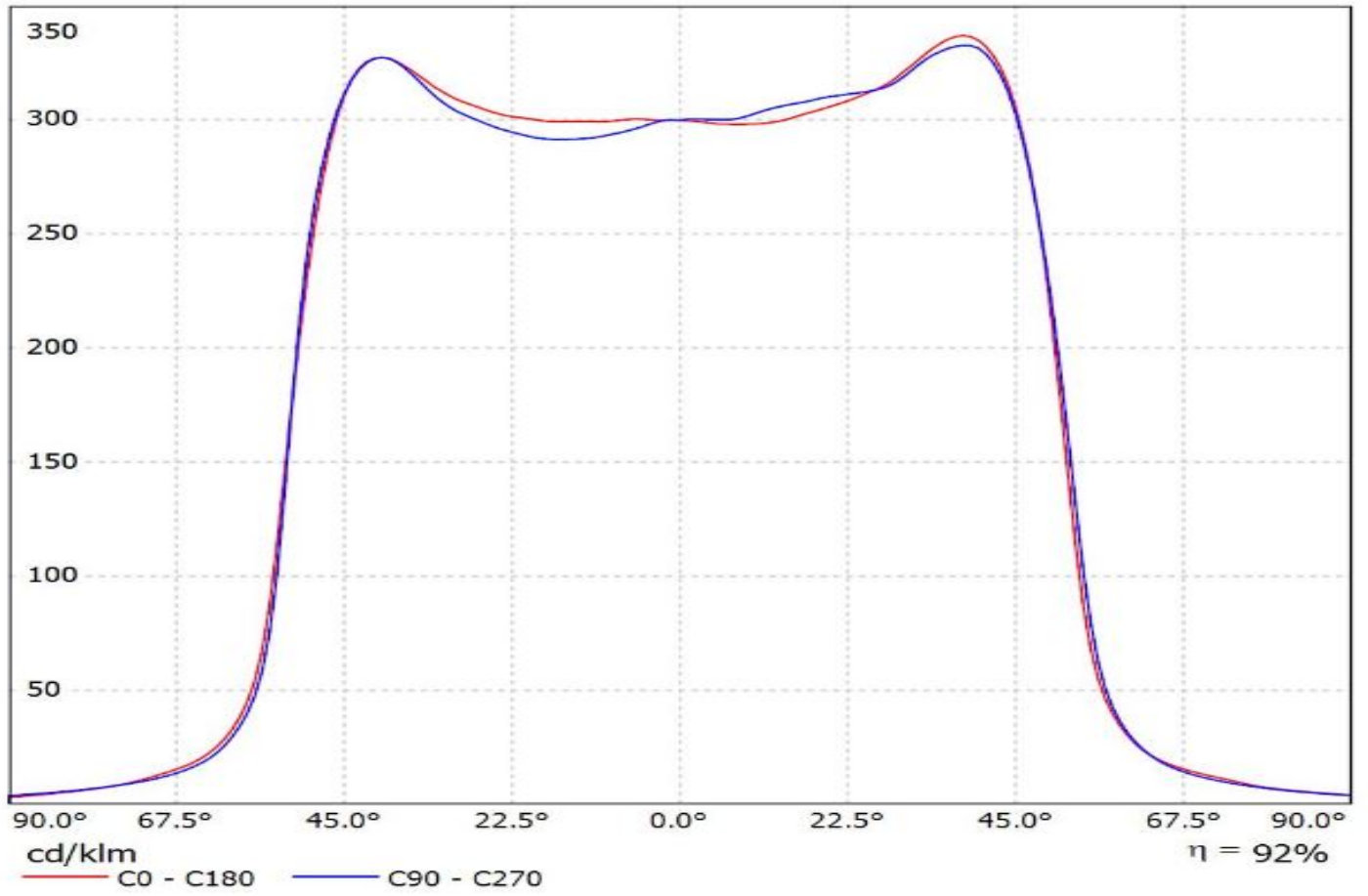

Luminaire: LEDiL Oy FCN14648_JENNY-CY_(XM-L)

Lamps: 1 x CREE_XM-L_EZW_128.713lm@250mA_P=1.50385W_I=249.9mA

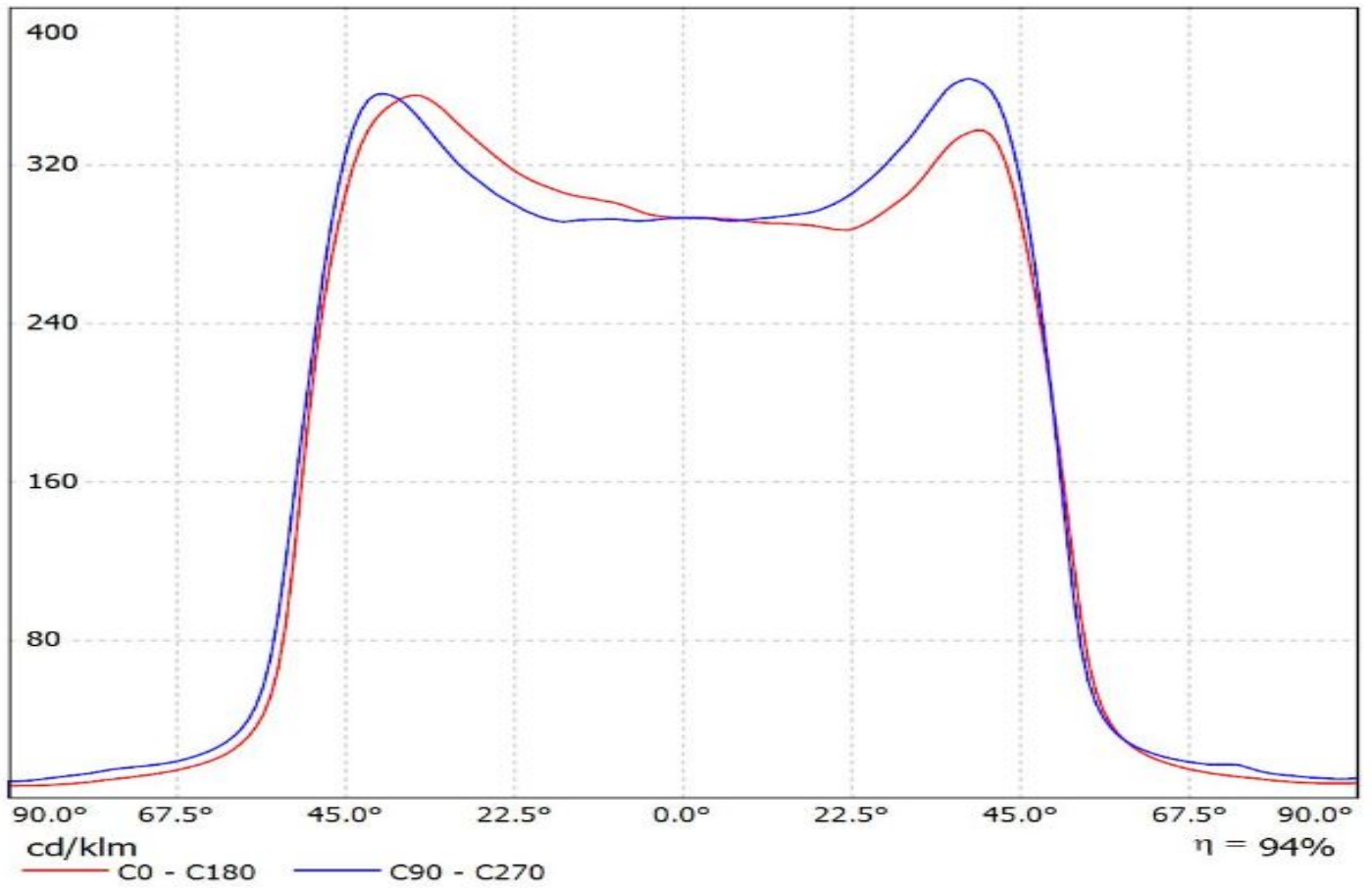

Luminaire: Ledil FCN14648_JENNY-CY_(LUXEON_5258)

Lamps: 1 x LUXEON_5258_(24VOLTS)_307.573lm@100mA_CCT=2700K_P=?W_I=0.1A

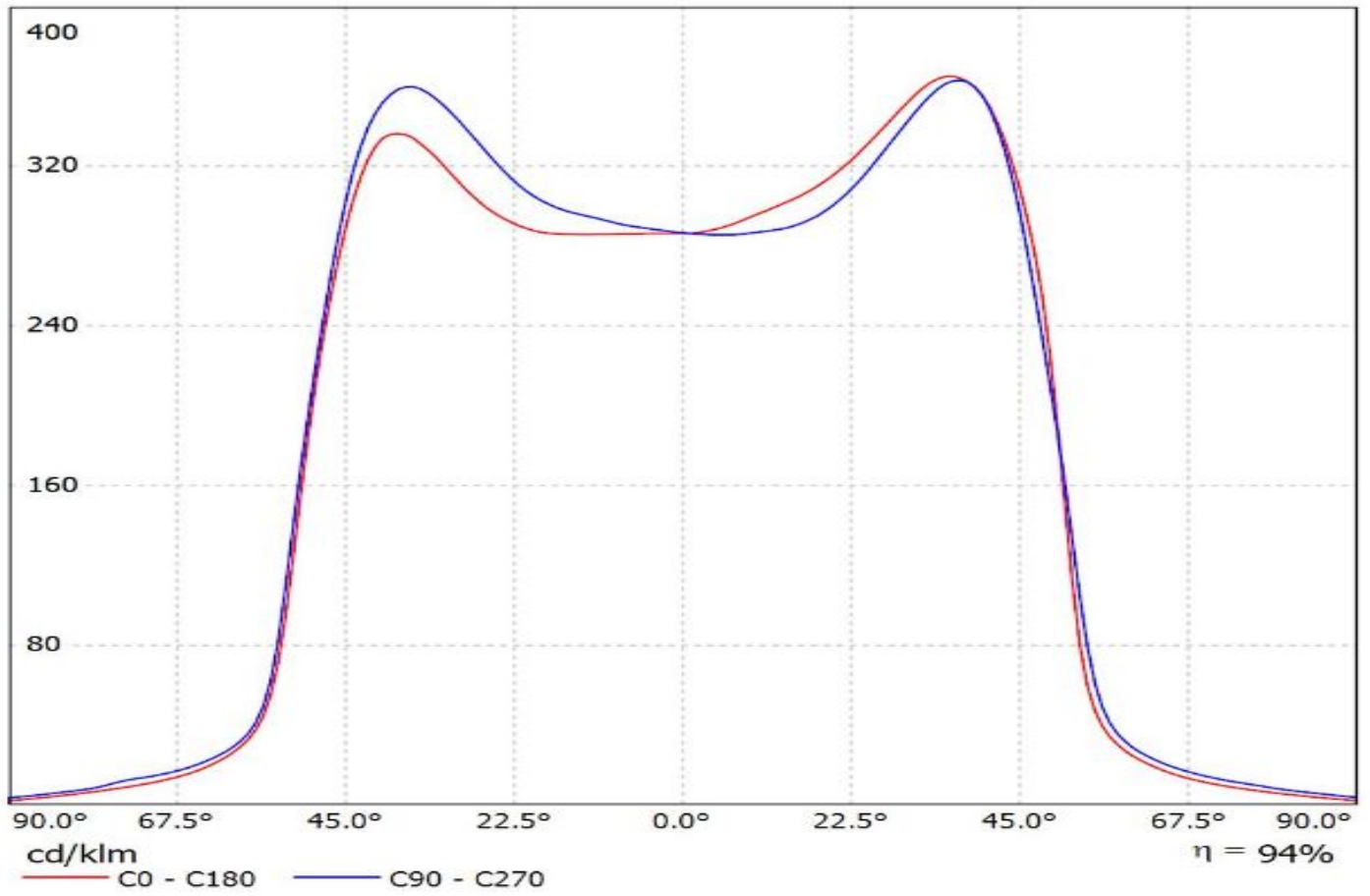

Luminaire: LEDiL Oy FCN14648_JENNY-CY_(LUXEON_M)
Lamps: 1 x LUXEON_M_(LXR7-SW40)_318.732lm@250mA_P=2.72282W_I=249.8mA

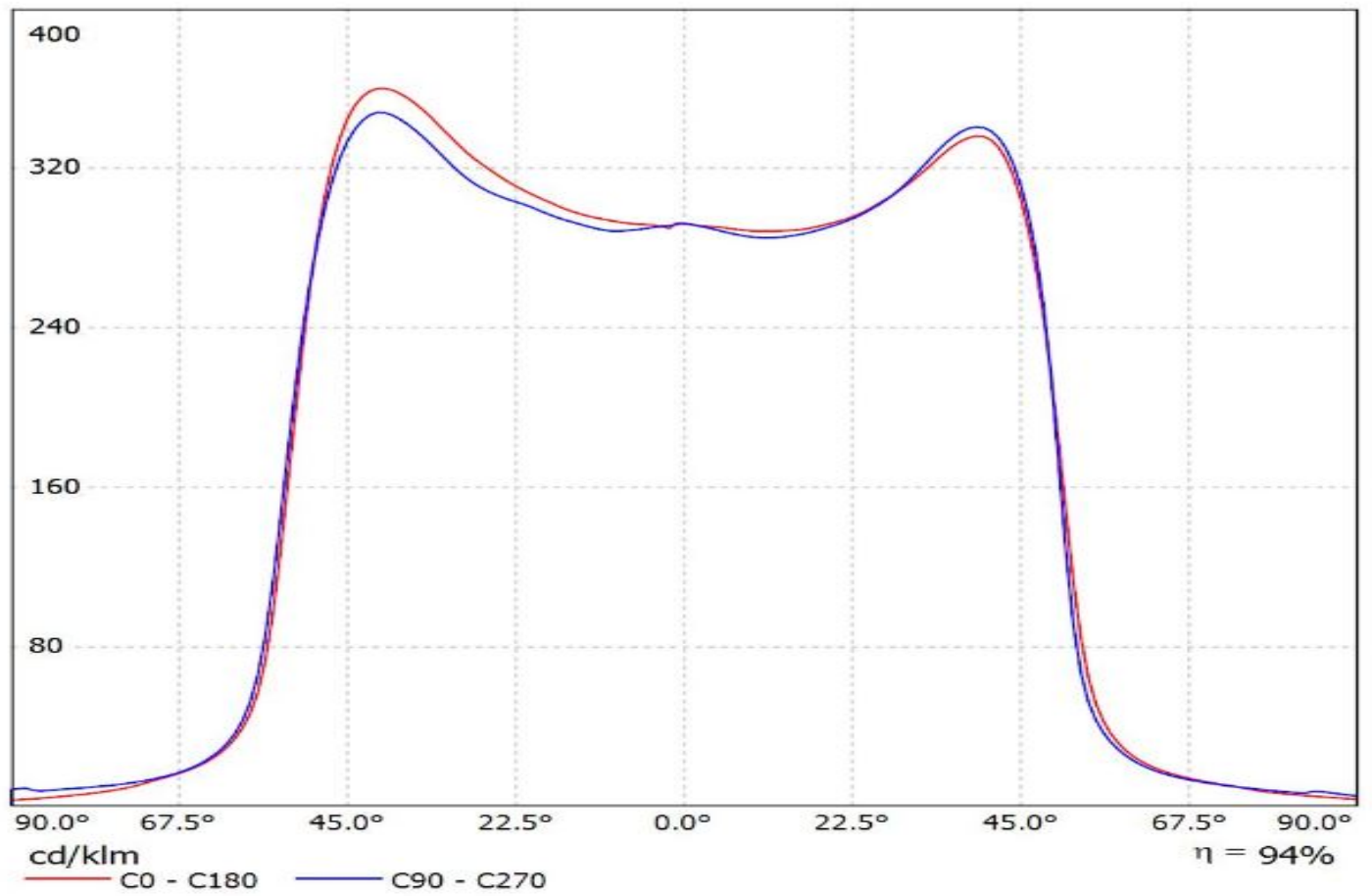

Luminaire: LEDiL Oy FCN14648_JENNY-CY_(NSMx286M)
Lamps: 1 x NICHIA_NSMx286M_(NSML286ME)_335.4lm@100mA_P=3.43543W_I=100.1mA

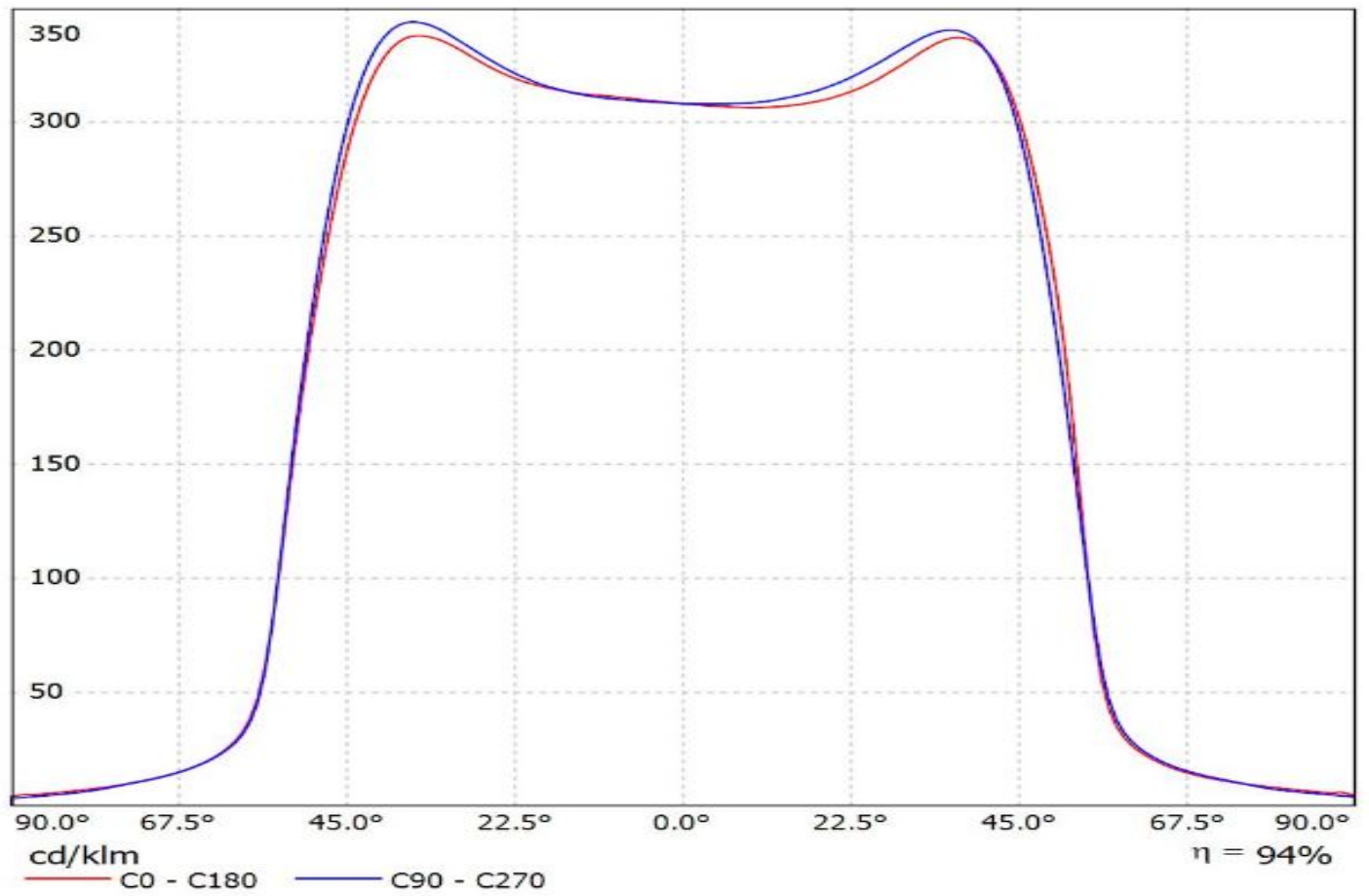

Luminaire: LEDiL Oy FCN14648_JENNY-CY_(NV4x144A)
Lamps: 1 x Nichia_NV4x144A_477.334lm@250mA_P=2.8030W_I=0.250A

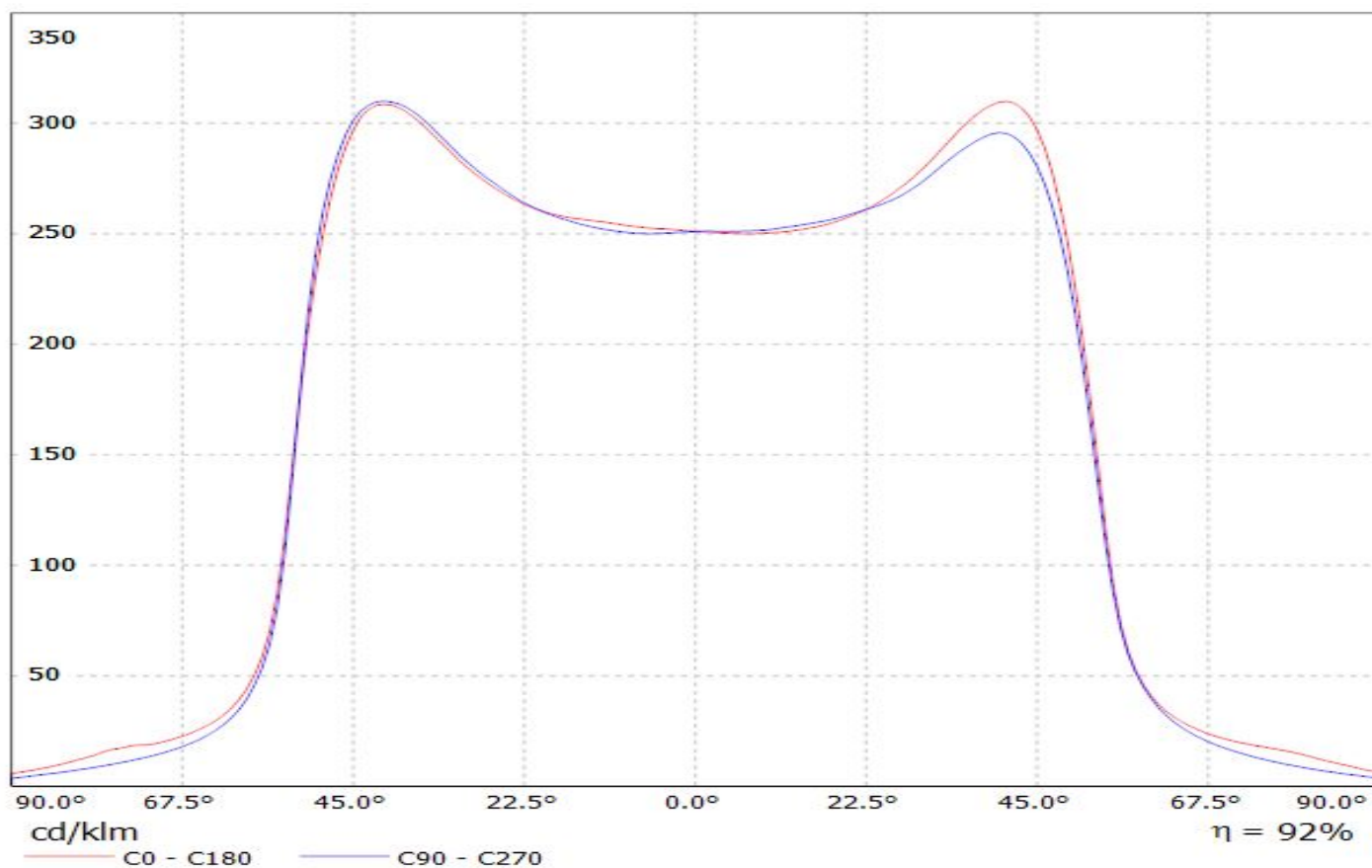

Luminaire: Ledil FCN14648_JENNY-CY_(Duris_S8)
Lamps: 1 x Osram_Duris_S8_(GW_P9LMS1.ÉC)_201.491lm@100mA_CCT=2857K_P=1.8W_I=0.1A

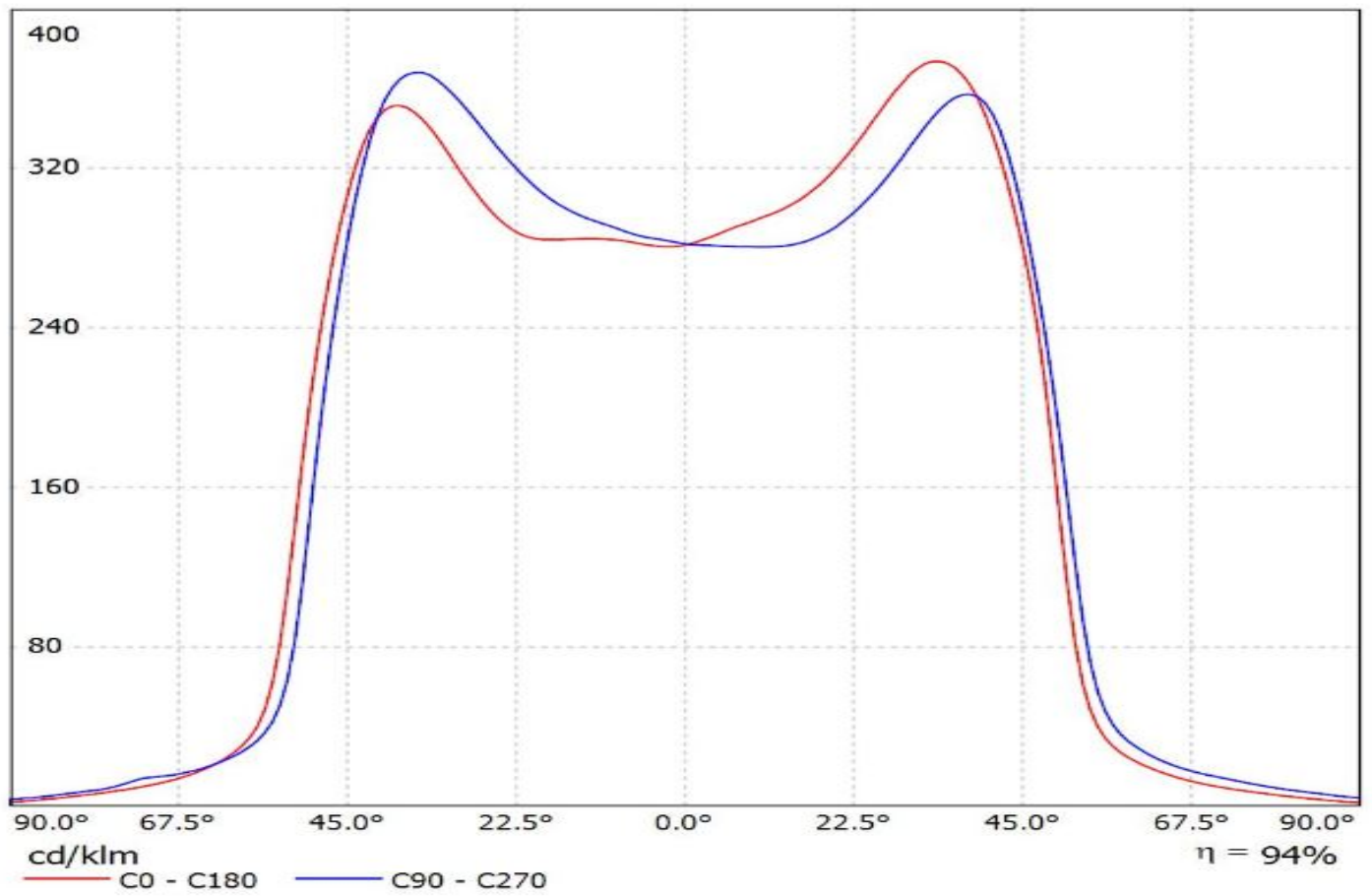

Luminaire: Ledil Oy FCN14648_JENNY-CY_(Duris_S10)_SIMULATED
Lamps: 1 x Osram Duris S10 (GW P7LM32.EM)

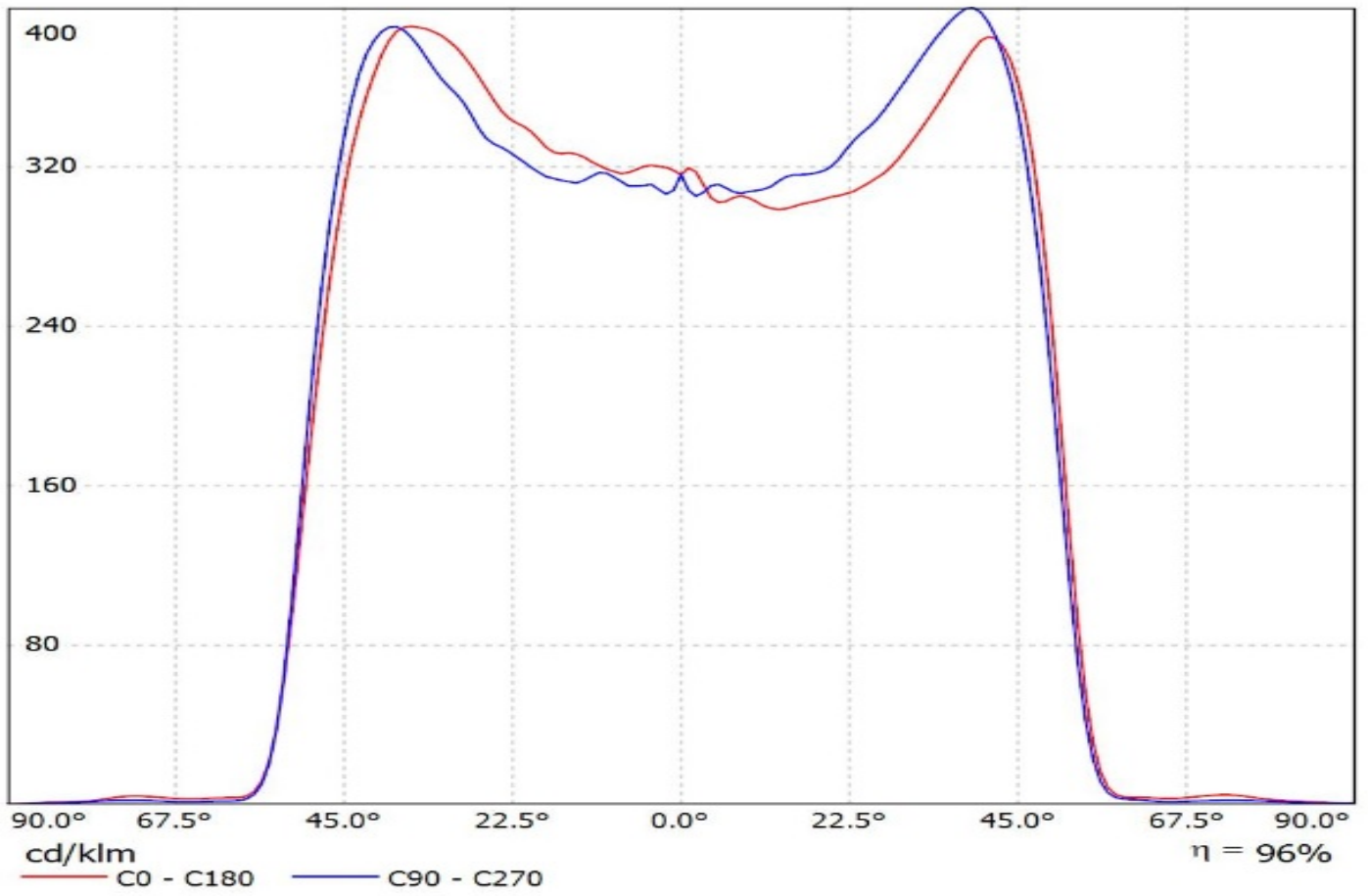

Luminaire: LEDiL Oy FCN14648_JENNY-CY_(P6)

Lamps: 1 x OSRAM_SOLERIQ_P6_(GW_MAFJB1.EM)_693.953lm@250mA_P=6.29348W_I=249.9mA

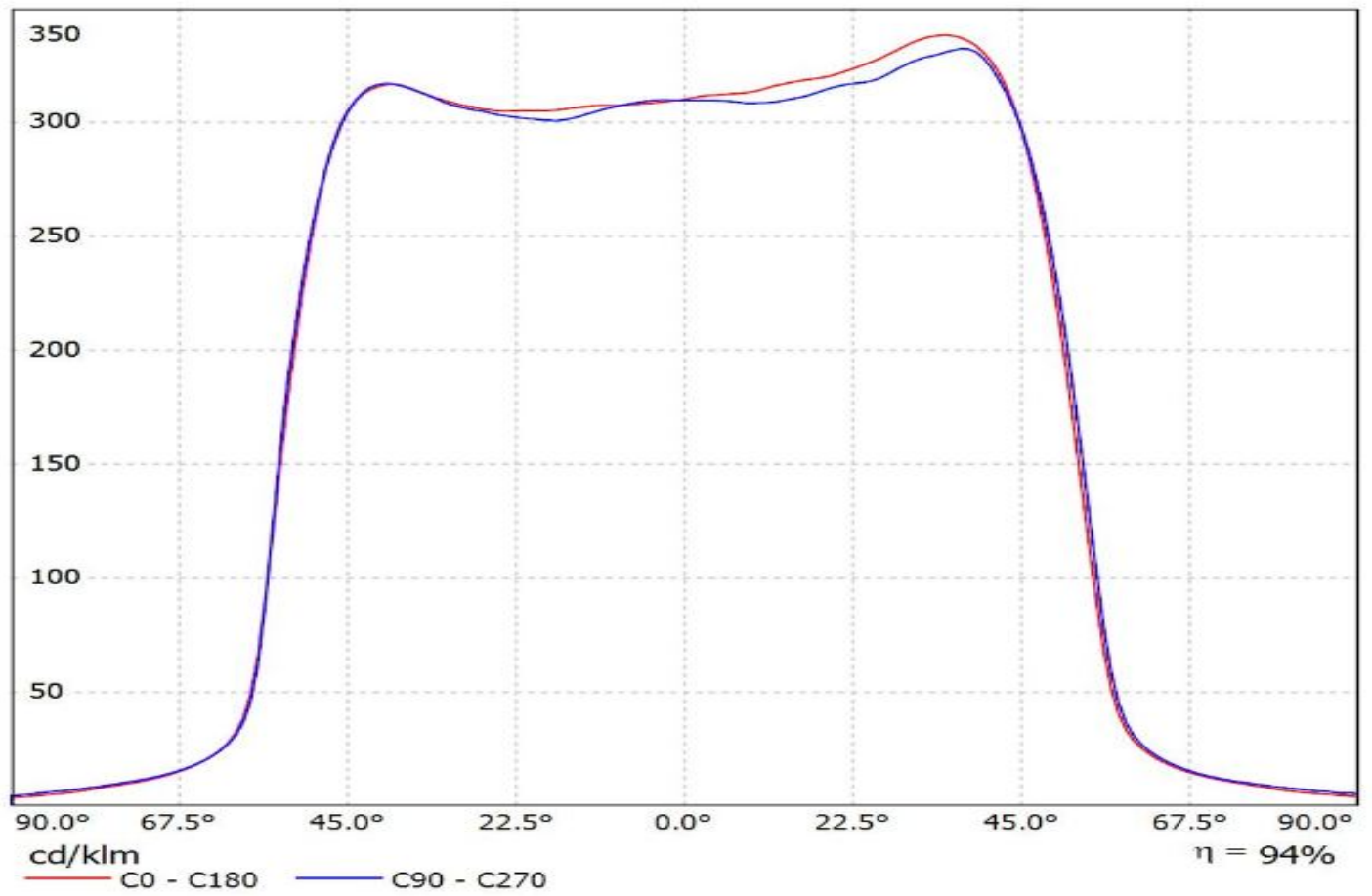

Luminaire: LEDiL Oy FCN14648_JENNY-CY_(P9)

Lamps: 1 x OSRAM_SOLERIQ_P9_(GW_MAFJB1.EM)_911lm@250mA_P=6.90072W_I=249.8mA

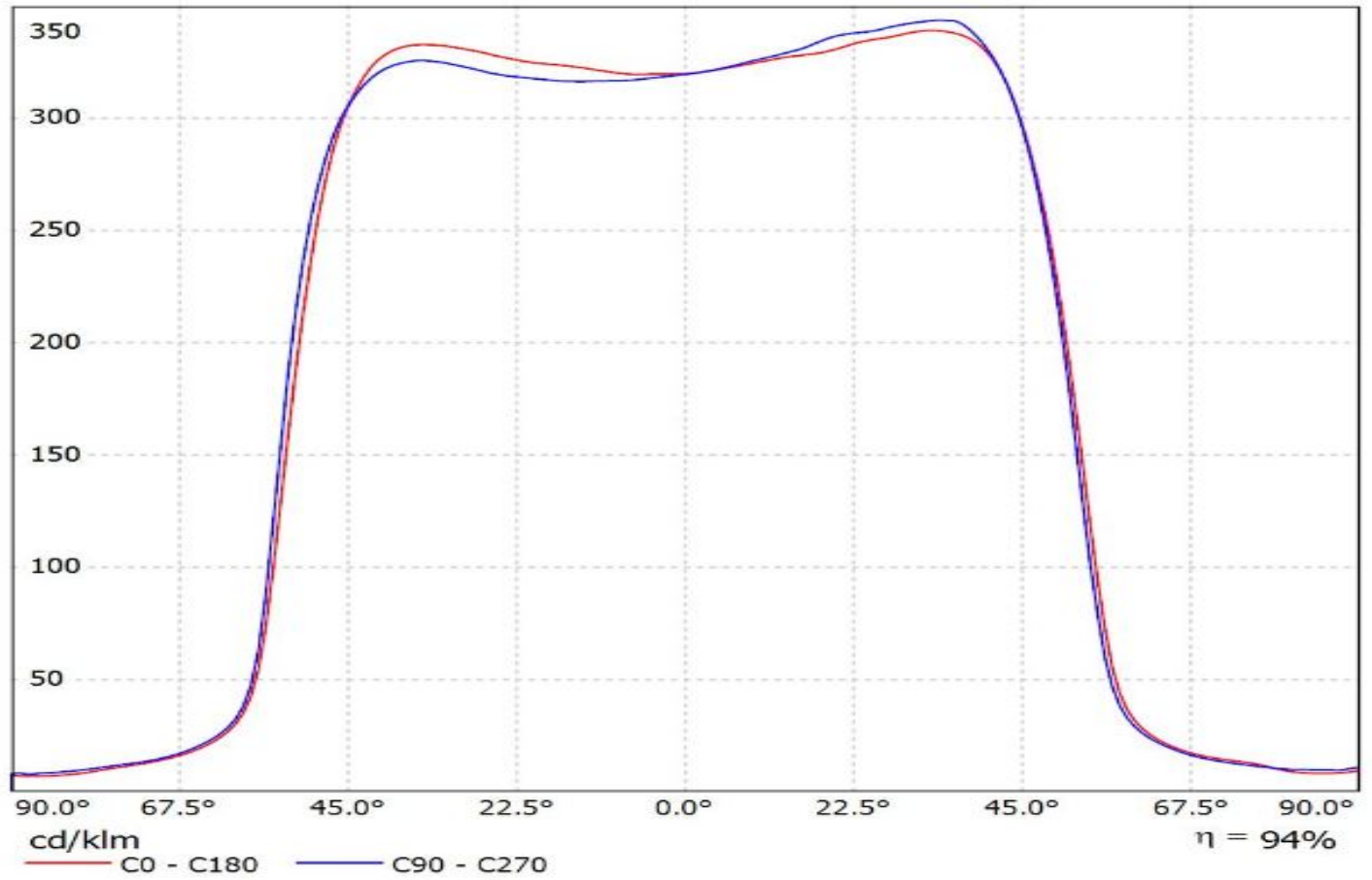

Luminaire: LEDiL Oy FCN14648_JENNY-CY (COB_D_LES_9.8mm)

Lamps: 1 x Samsung_COB_D_series_LES_9.8mm_LC013D_534.999lm@100mA_P=3.1948W_I=0.100A

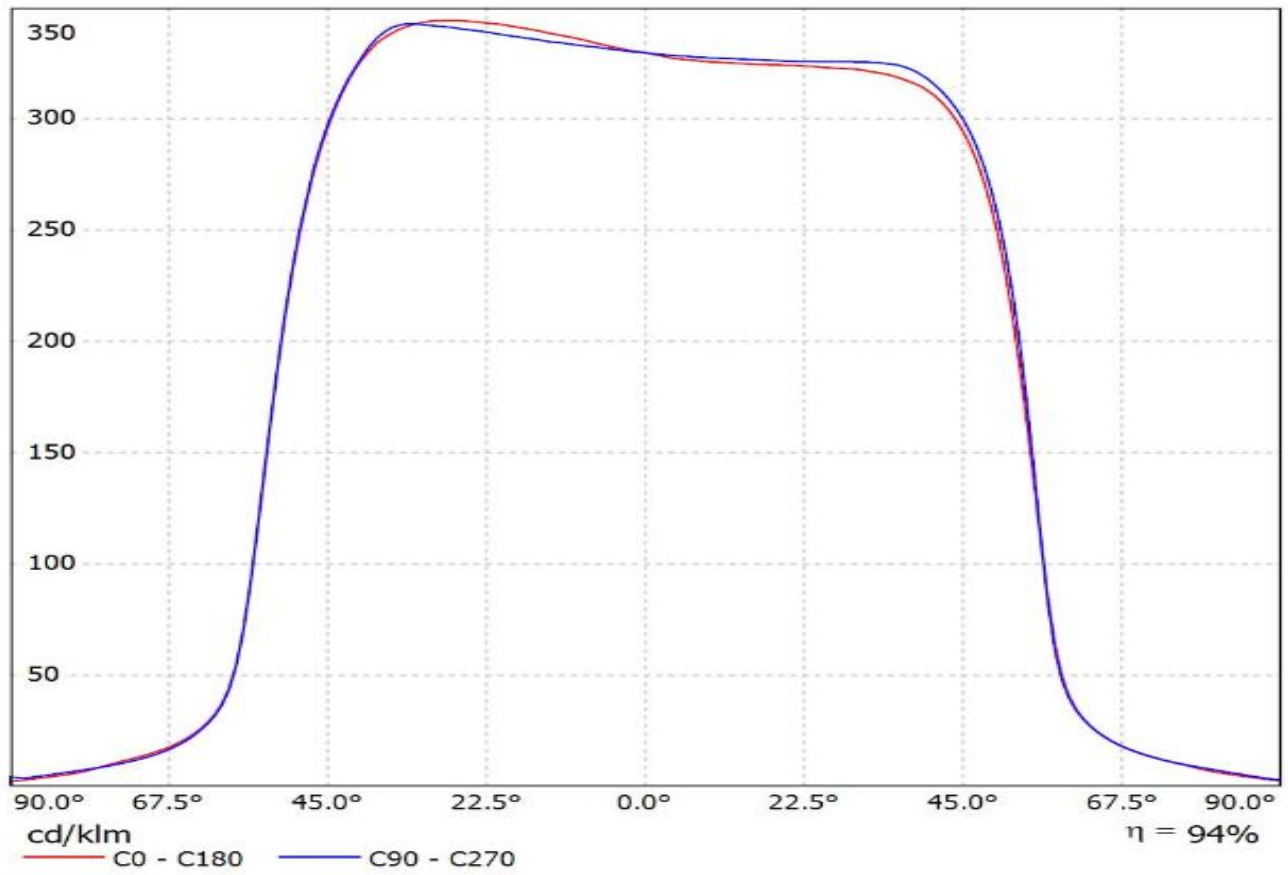

Luminaire: Ledil FCN14648_JENNY-CY_(MJT_12W_Les9,8)

Lamps: 1 x Seoul_MJT_12W_Les9.8mm_(SAWx1063A)_1245.58lm@250mA_P=8.30025W_I=0.25A

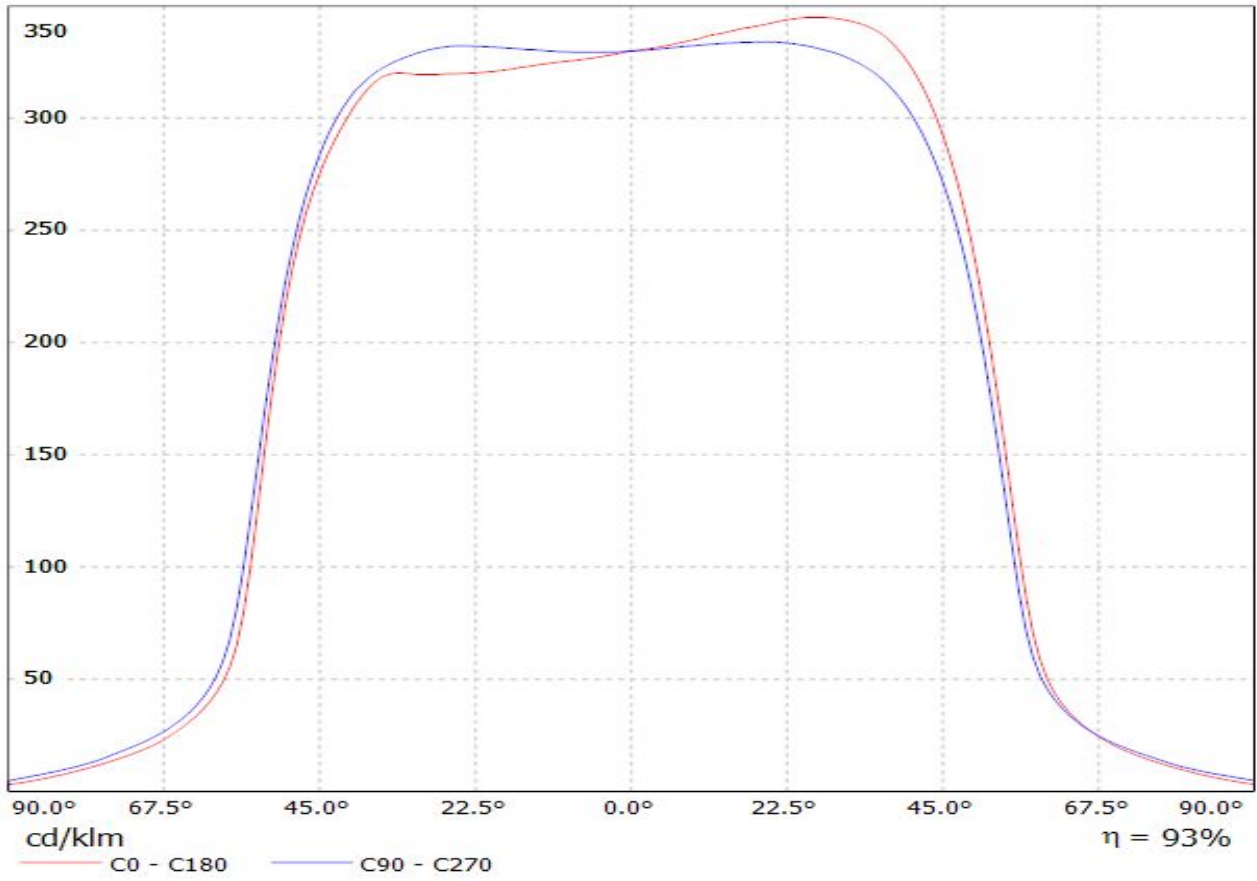

Luminaire: Ledil FCN14648_JENNY-CY_(MJT_6W_Les6)

Lamps: 1 x Seoul_MJT_6W_Les6mm_(SAWx0661A)_820.711lm@180mA_P=6.3909W_I=0.18A

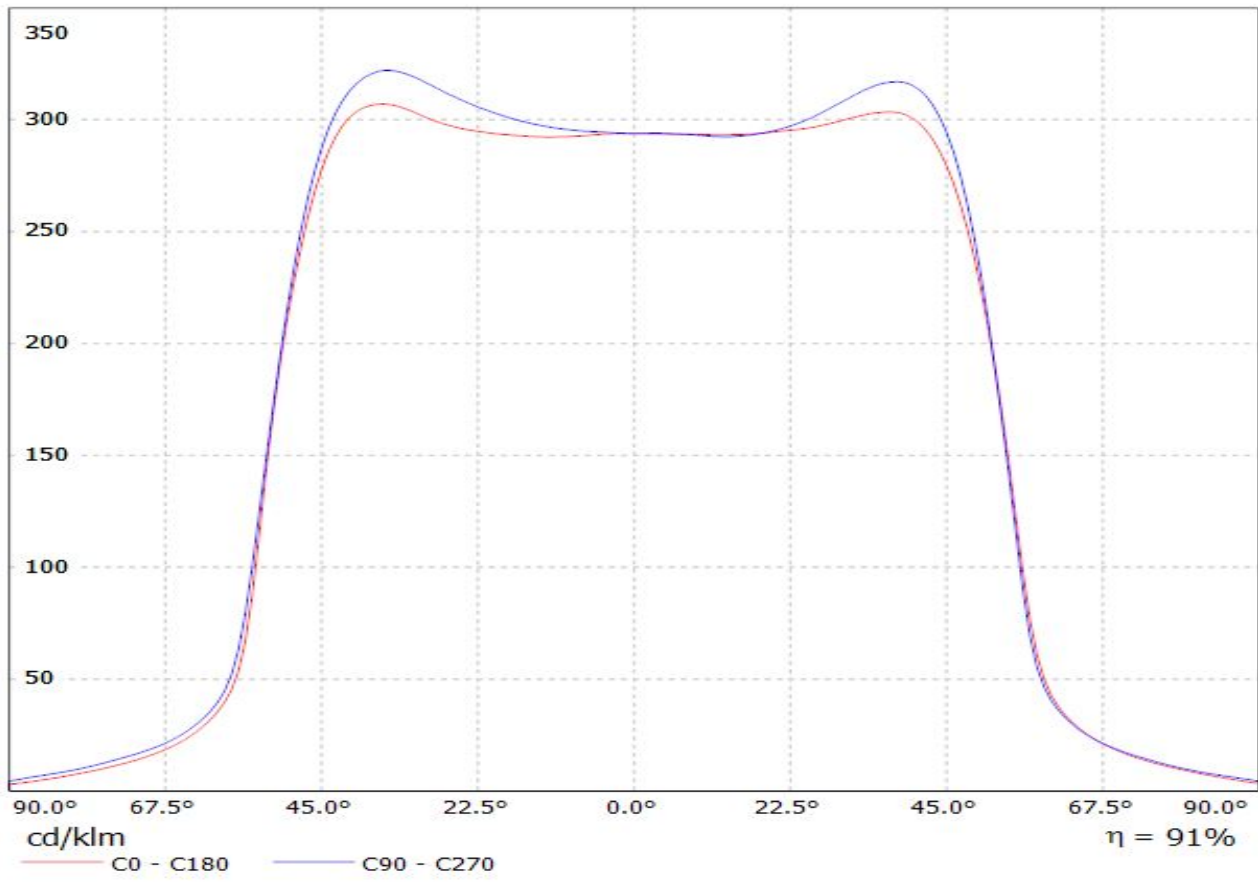

Luminaire: LEDiL Oy FCN14648_JENNY-CY_(SLE-G5_LES-6)
Lamps: 1 x Tridonic_SLE-G5_LES-6_470.842lm@100mA_P=3.3743W_I=0.100A

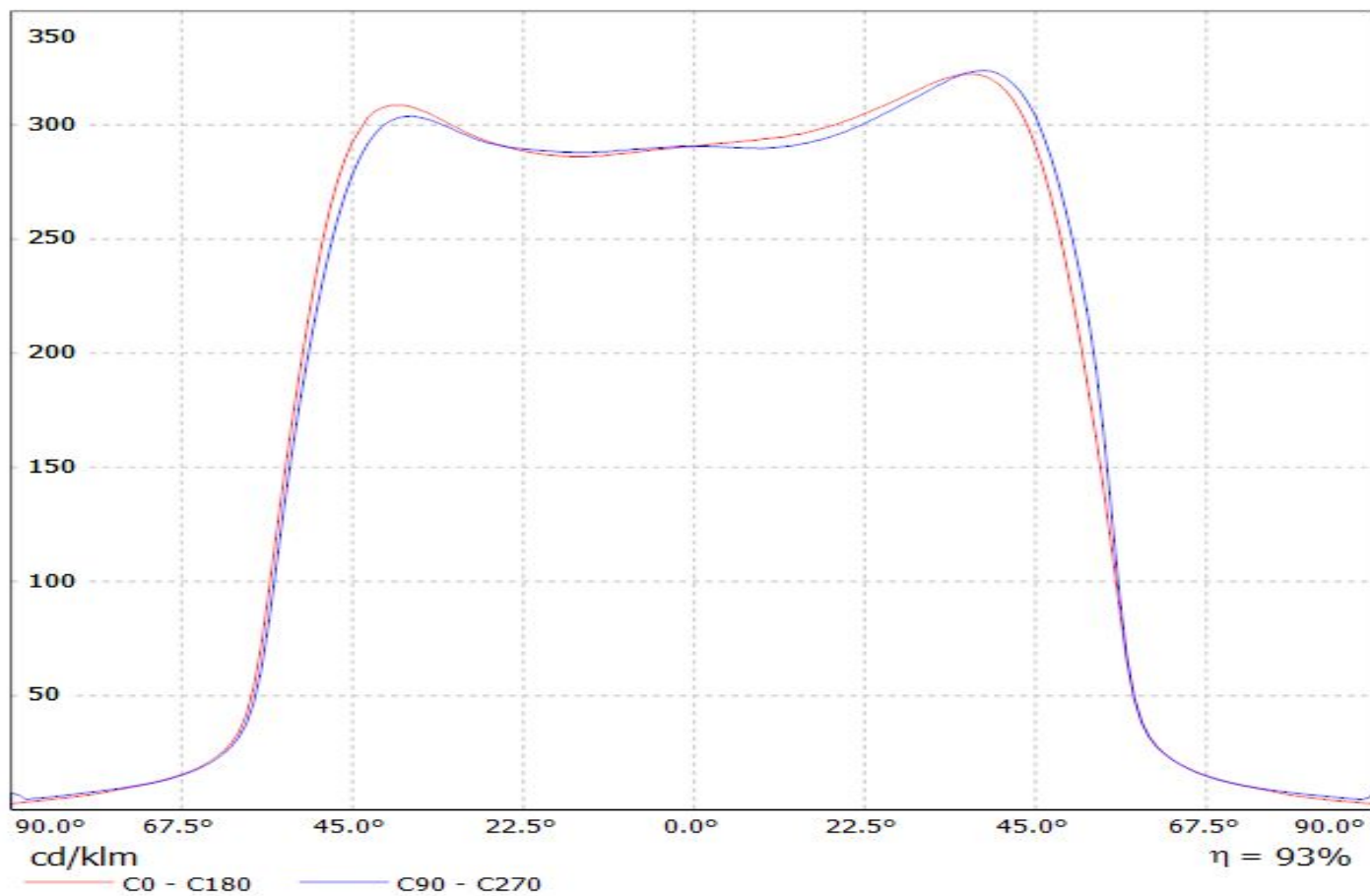

Luminaire: LEDiL Oy FCN14648_JENNY-CY_(SLE-G5_LES-11)
Lamps: 1 x Tridonic_SLE-G5_LES-11_1186.5lm@250mA_P=8.3528W_I=0.250A

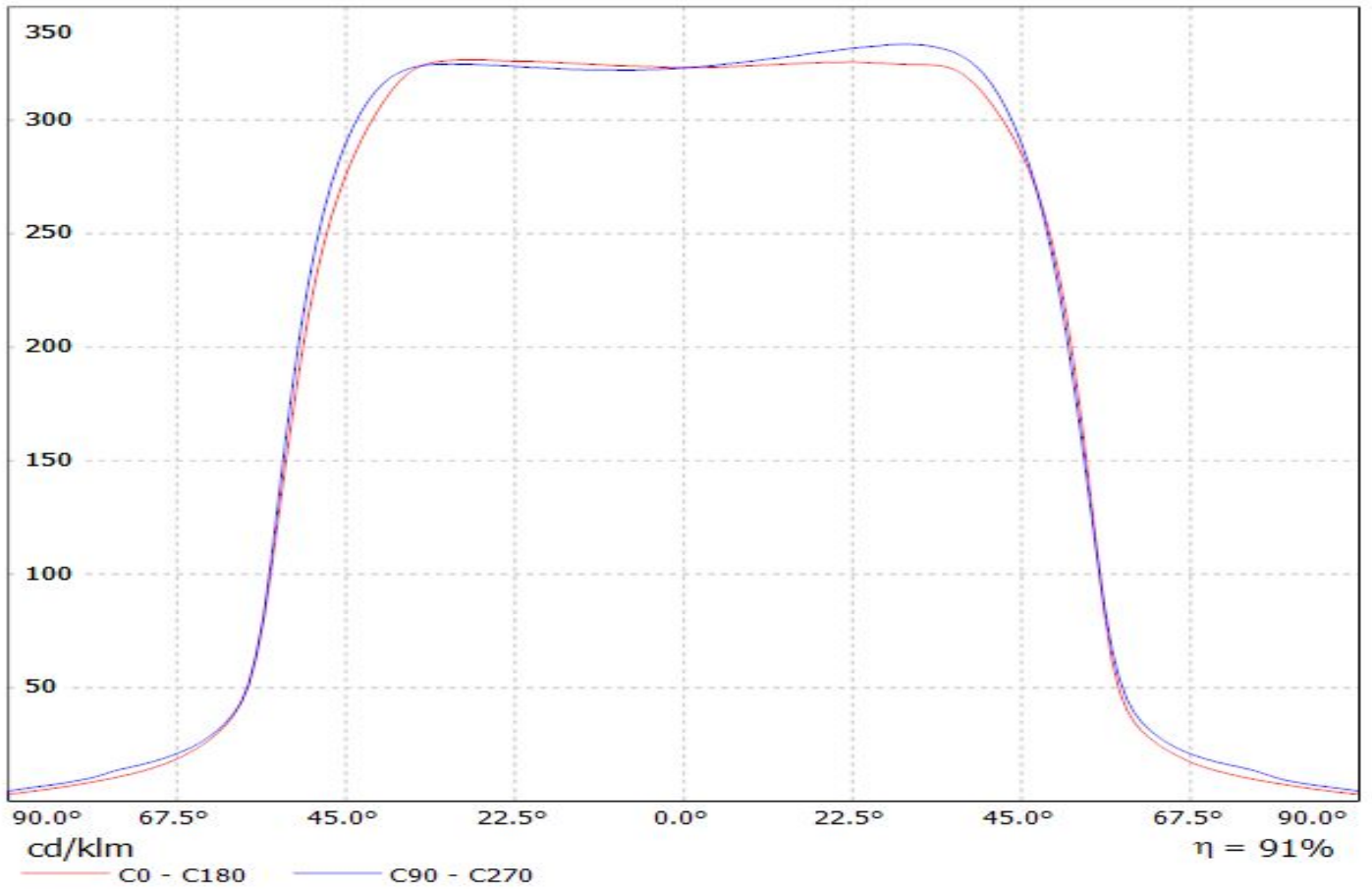

Luminaire: LEDiL Oy FCN14648_JENNY-CY_(V6)

Lamps: 1 x BRIDGELUX_V6_447.582lm@250mA_P=5.15119W_I=249.9mA

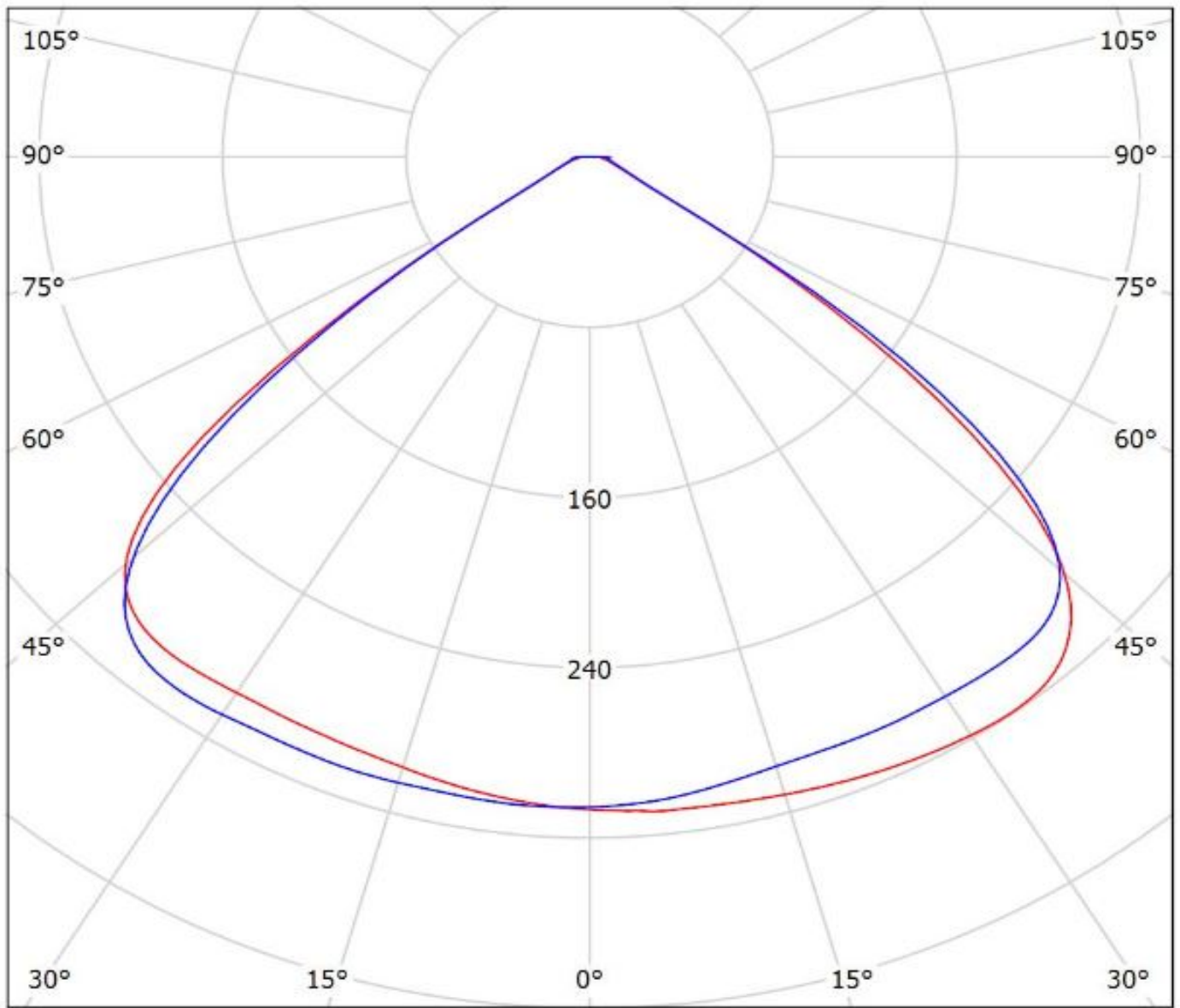

cd/klm

— C0 - C180 — C90 - C270

$\eta = 94\%$

Luminaire: LEDiL Oy FCN14648_JENNY-CY_(V8)

Lamps: 1 x BRIDGELUX_V8_871.869lm@250mA_P=8.88614W_I=249.8mA

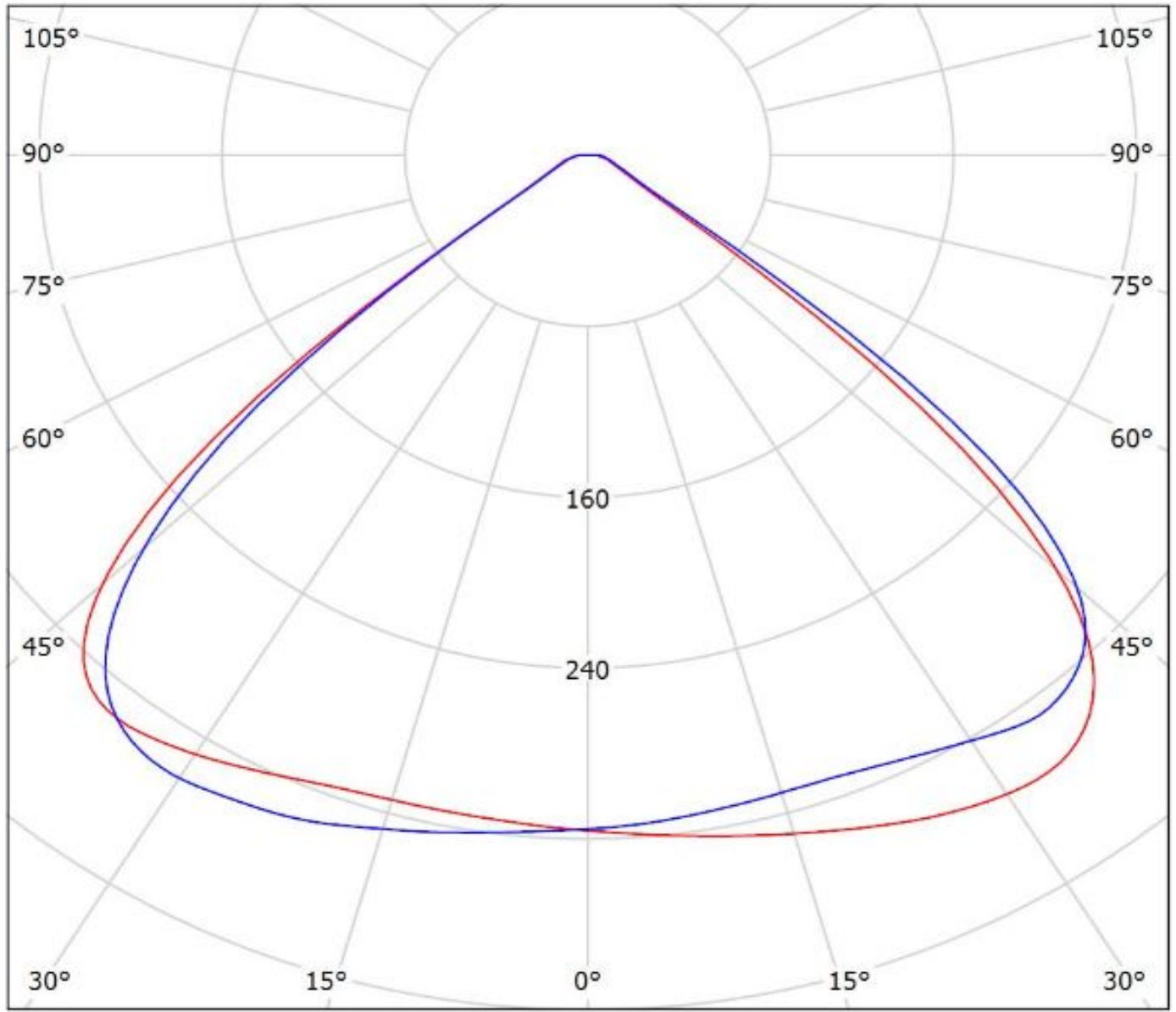

cd/klm

— C0 - C180 — C90 - C270

$\eta = 94\%$

Luminaire: LEDiL Oy FCN14648_JENNY-CY_(V10)

Lamps: 1 x BRIDGELUX_V10_(BXRE-30E1000B-X2)_763.702lm@250mA_P=6.32922W_I=249.9mA

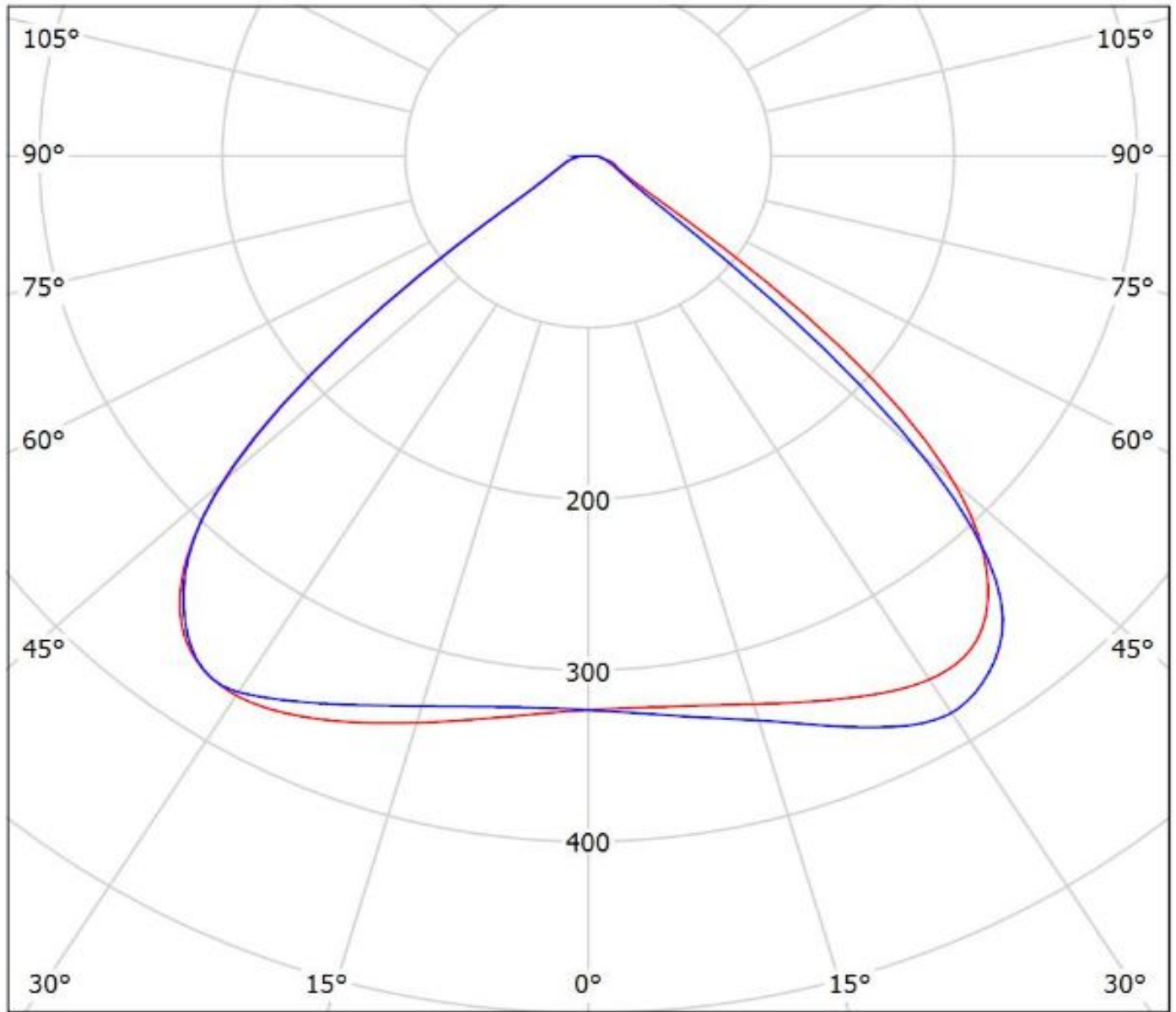

cd/klm

— C0 - C180 — C90 - C270

η = 94%

Luminaire: Ledil Oy FCN14648_JENNY-CY_BRIDGELUX_V10_Gen7_SIMULATED
Lamps: 1 x BRIDGELUX V10 Gen7

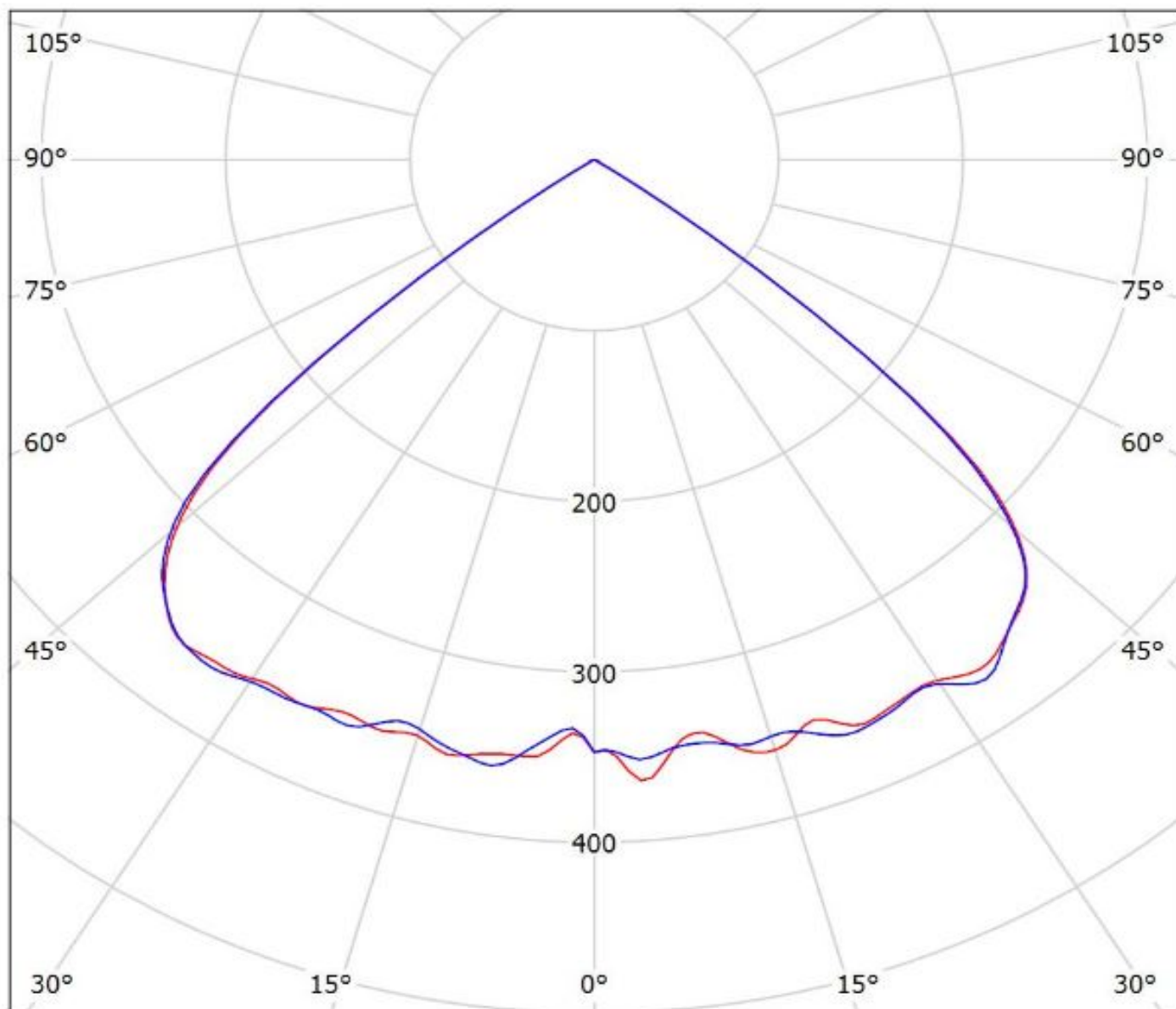

cd/klm

— C0 - C180 — C90 - C270

$\eta = 94\%$

Luminaire: LEDiL Oy FCN14648_JENNY-CY_(CLL010)

Lamps: 1 x CITIZEN_CLL010_(CLL010-0305A1-303M1A2)_206.314lm@250mA_P=2.27184W_I=249.9mA

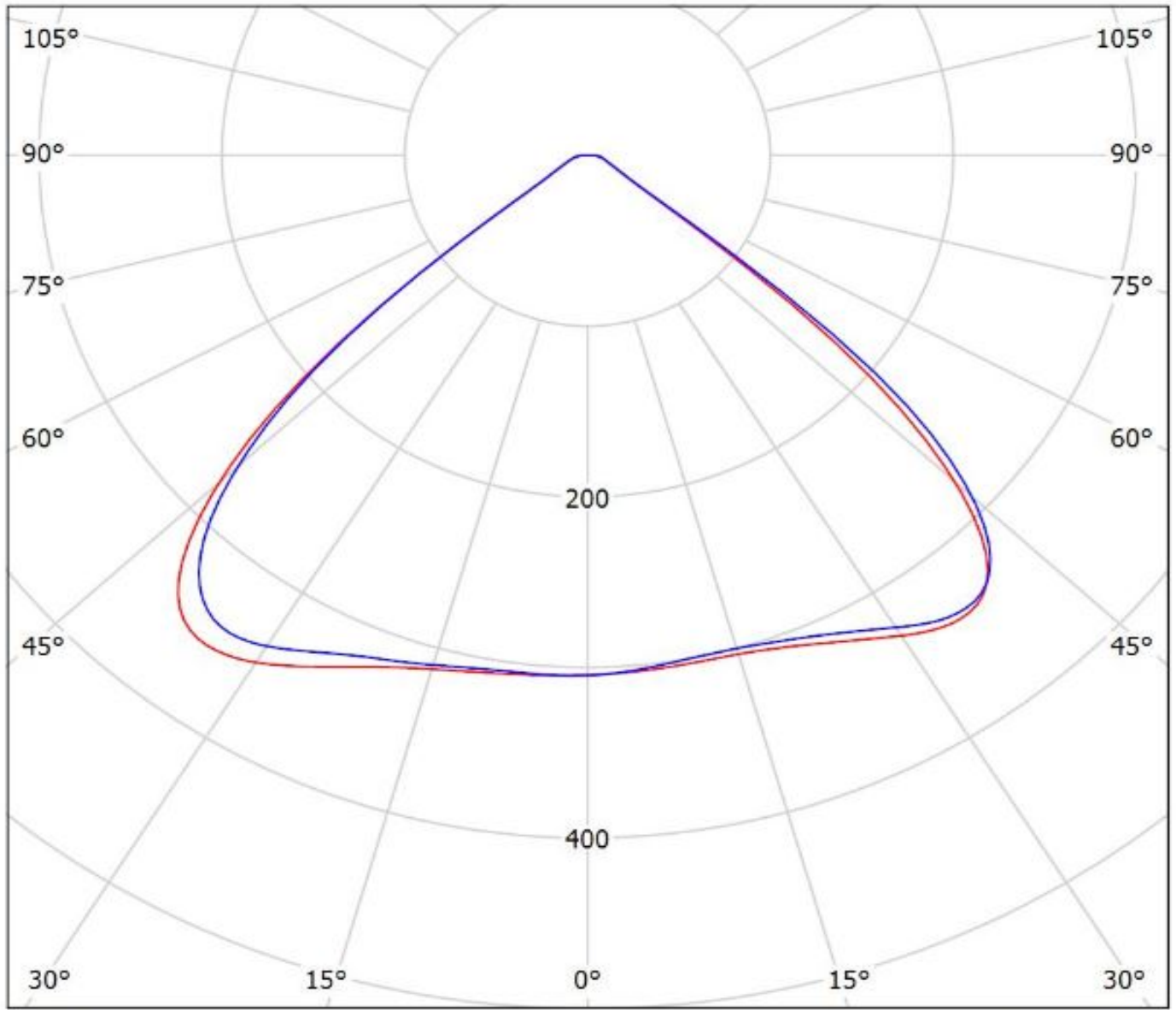

cd/klm

— C0 - C180 — C90 - C270

$\eta = 94\%$

Luminaire: LEDiL Oy FCN14648_JENNY-CY_(CLL022)

Lamps: 1 x CITIZEN_CLL022_(CLL022-1204A5-030H7E1)_748.012lm@250mA_P=8.70803W_I=249.8mA

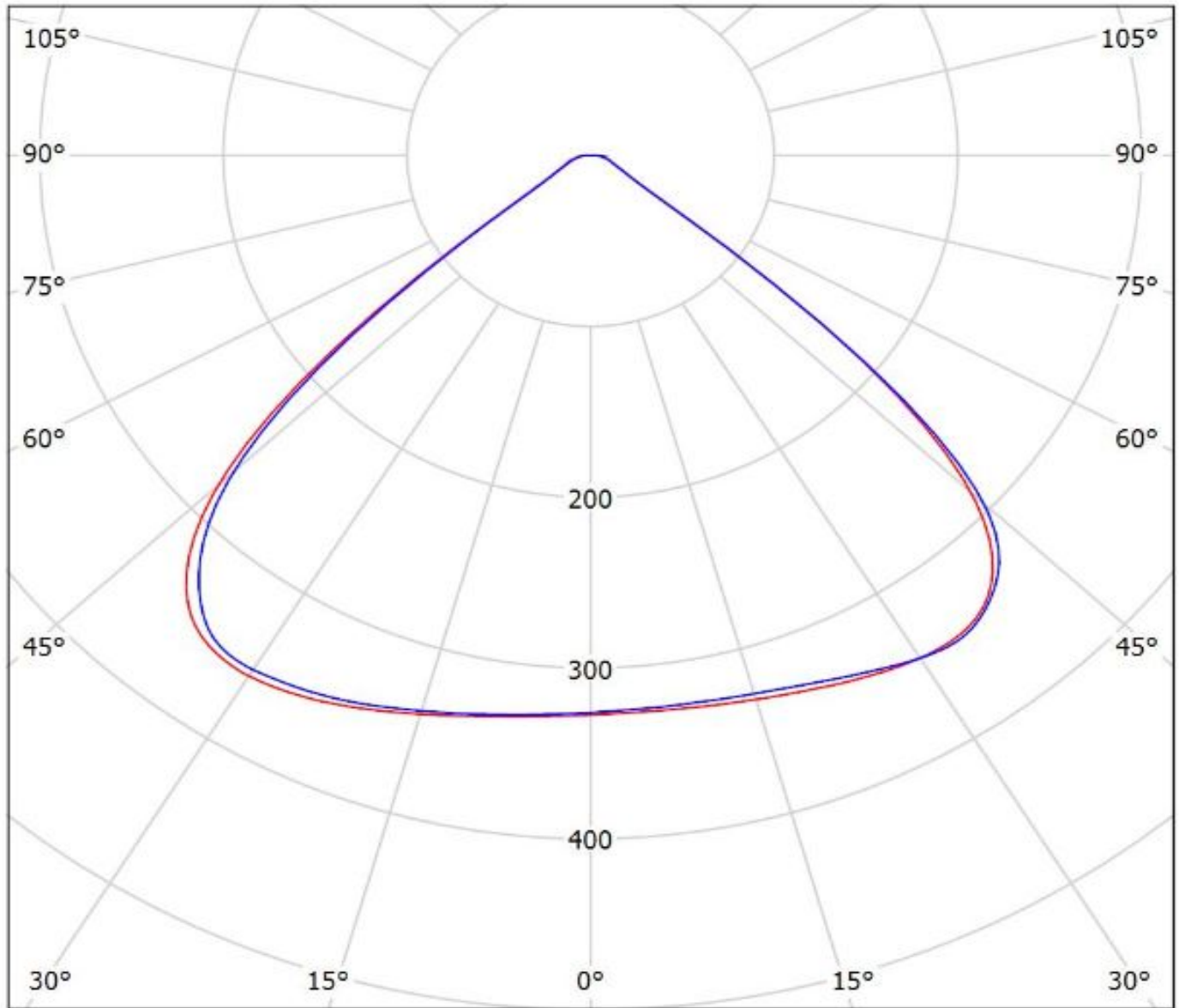

cd/klm

— C0 - C180

— C90 - C270

$\eta = 93\%$

Luminaire: Ledil FCN14648_JENNY-CY_(CLU700)

Lamps: 1 x Citizen_CLU700_394.637lm@100mA_P=2.8W_I=0.10A

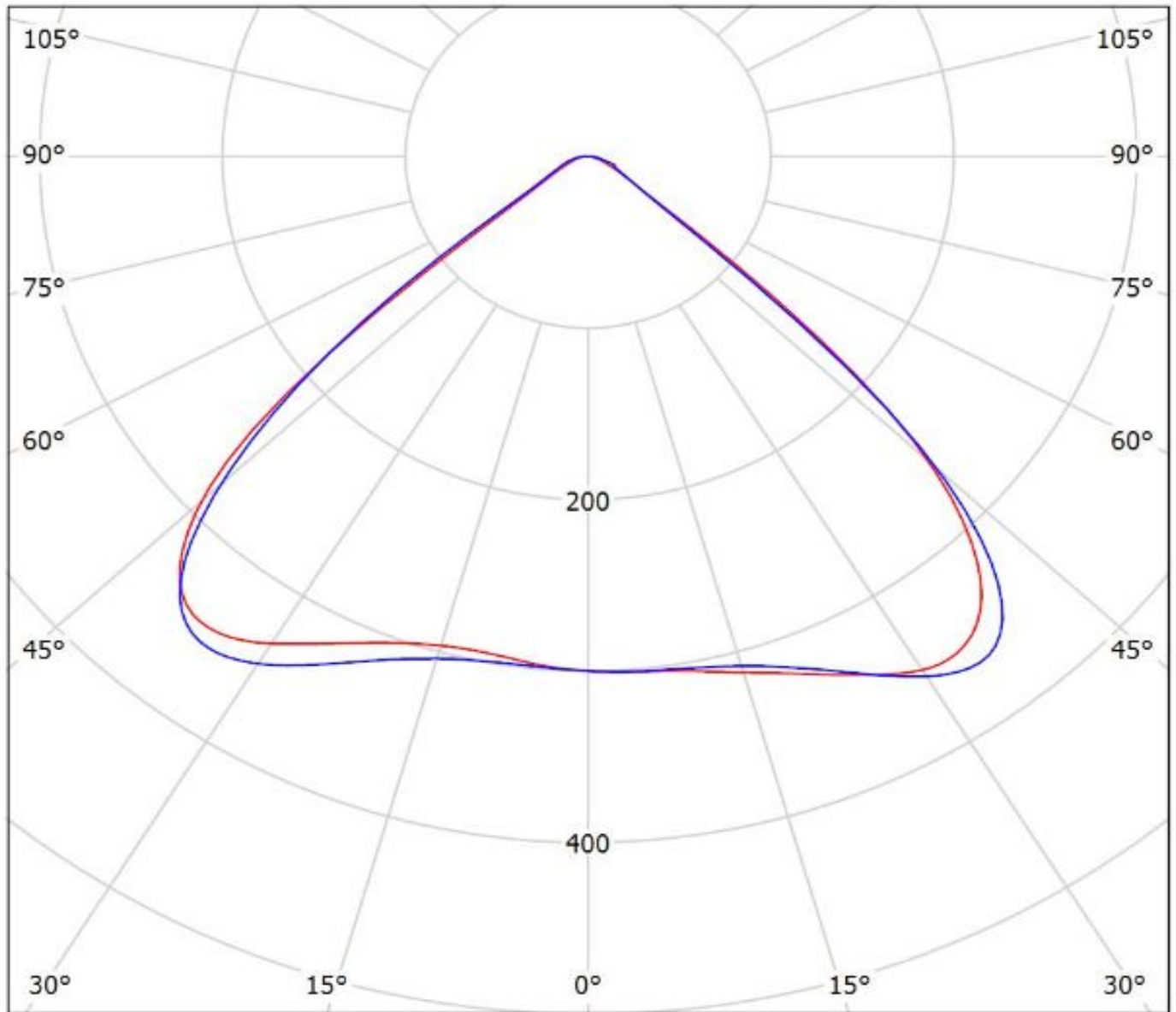

cd/klm

— C0 - C180

— C90 - C270

$\eta = 93\%$

Ledil F14531_JENNY-CY_(XHP50) / LDC (Polar)

Luminaire: Ledil F14531_JENNY-CY_(XHP50)

Lamps: 1 x XHP50_warm_white_210.85lm@250mA_P=1.4W_I=0.25A

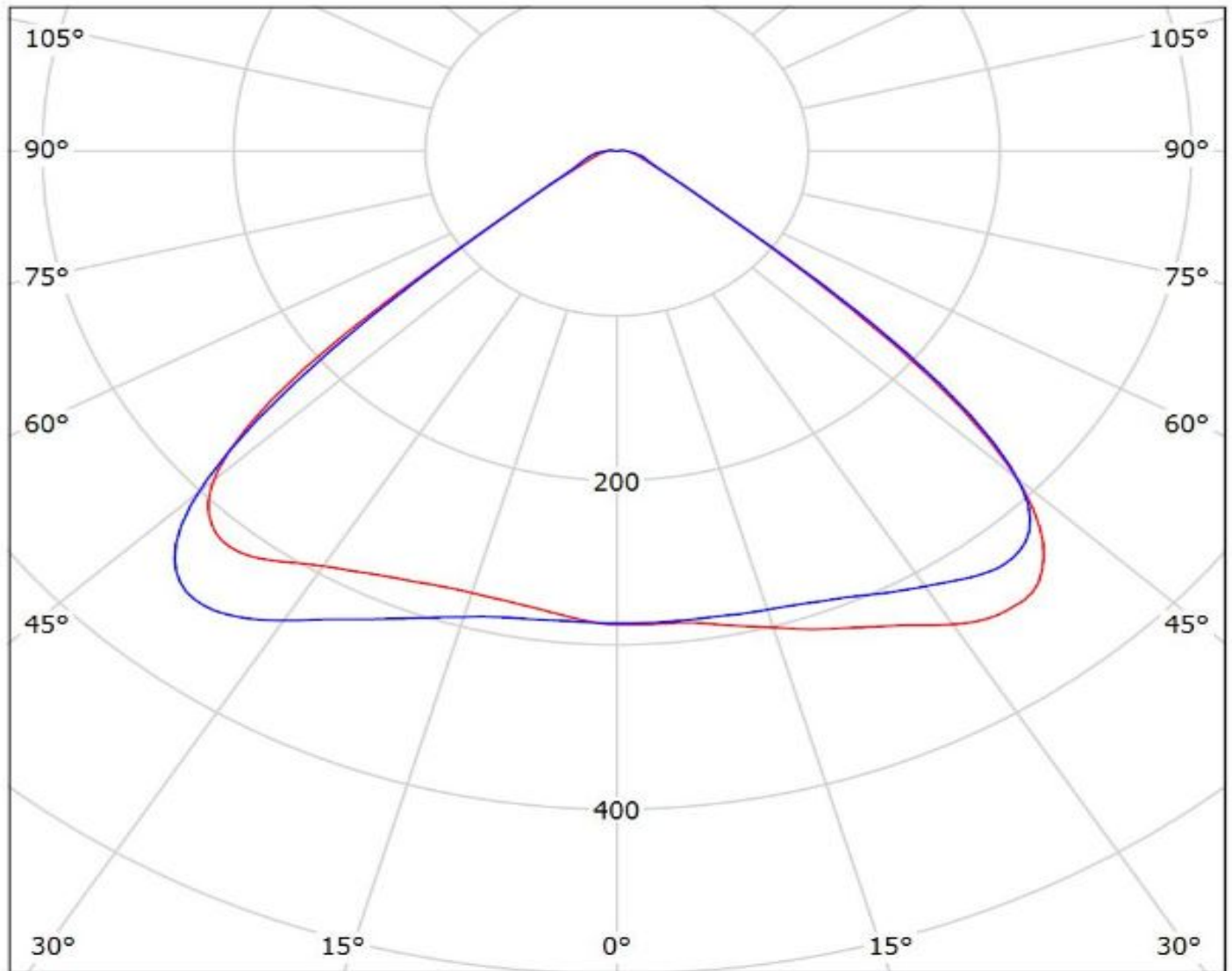

cd/klm

— C0 - C180 — C90 - C270

$\eta = 94\%$

Luminaire: LEDiL Oy FCN14648_JENNY-CY_(CXA1310)

Lamps: 1 x CREE_CXA1310_(CXA1310-30H-G4-F0Y-00001)_367.9lm@250mA_CCT=3000K_P=4.22112W_I=249.8mA

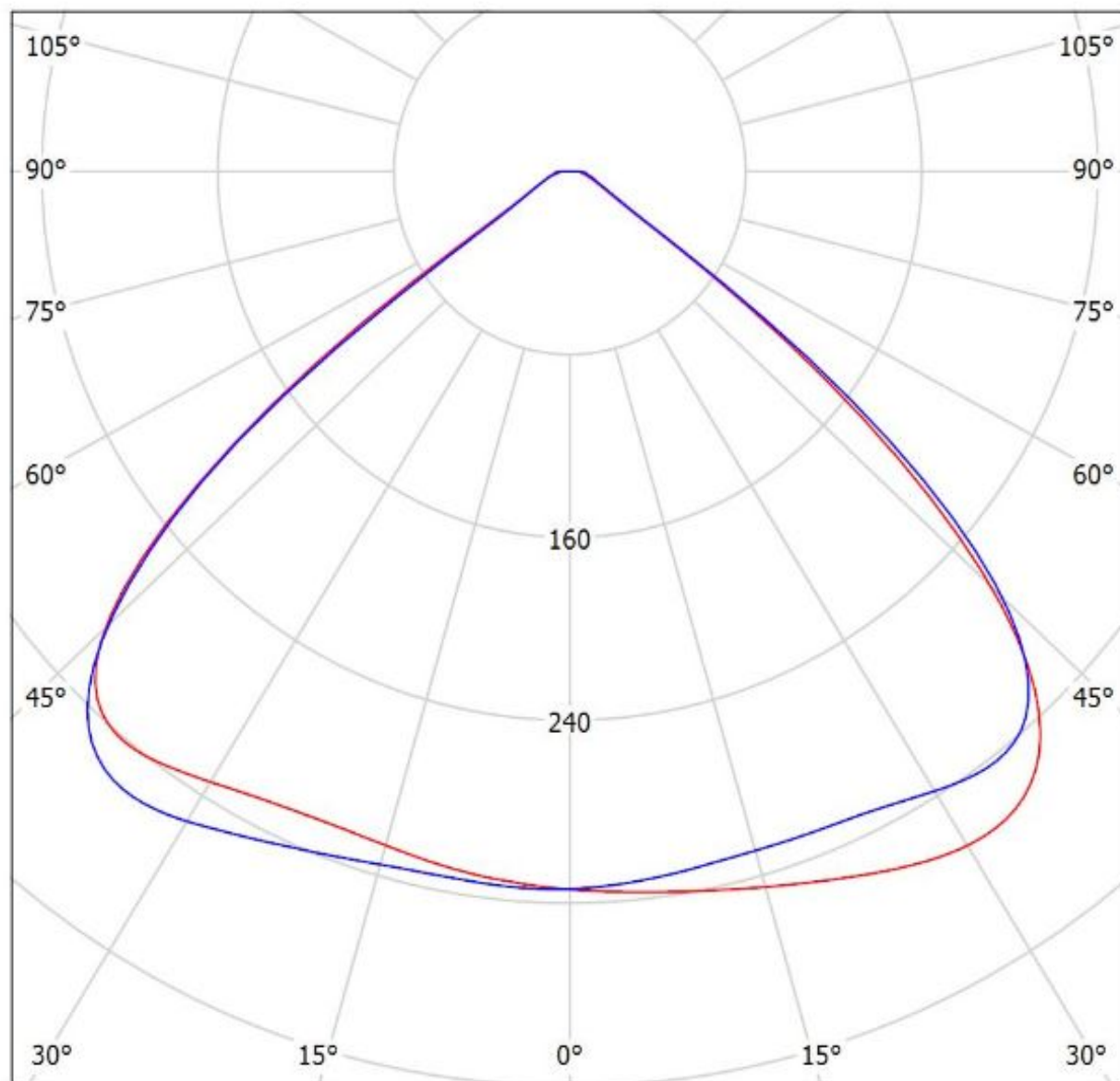

cd/klm

— C0 - C180 — C90 - C270

$\eta = 94\%$

Luminaire: LEDiL Oy FCN14648_JENNY-CY_(MK-R)

Lamps: 1 x MK-R_353.258lm@250mA_CCT=3276K_P=2.84836W_I=249.9mA

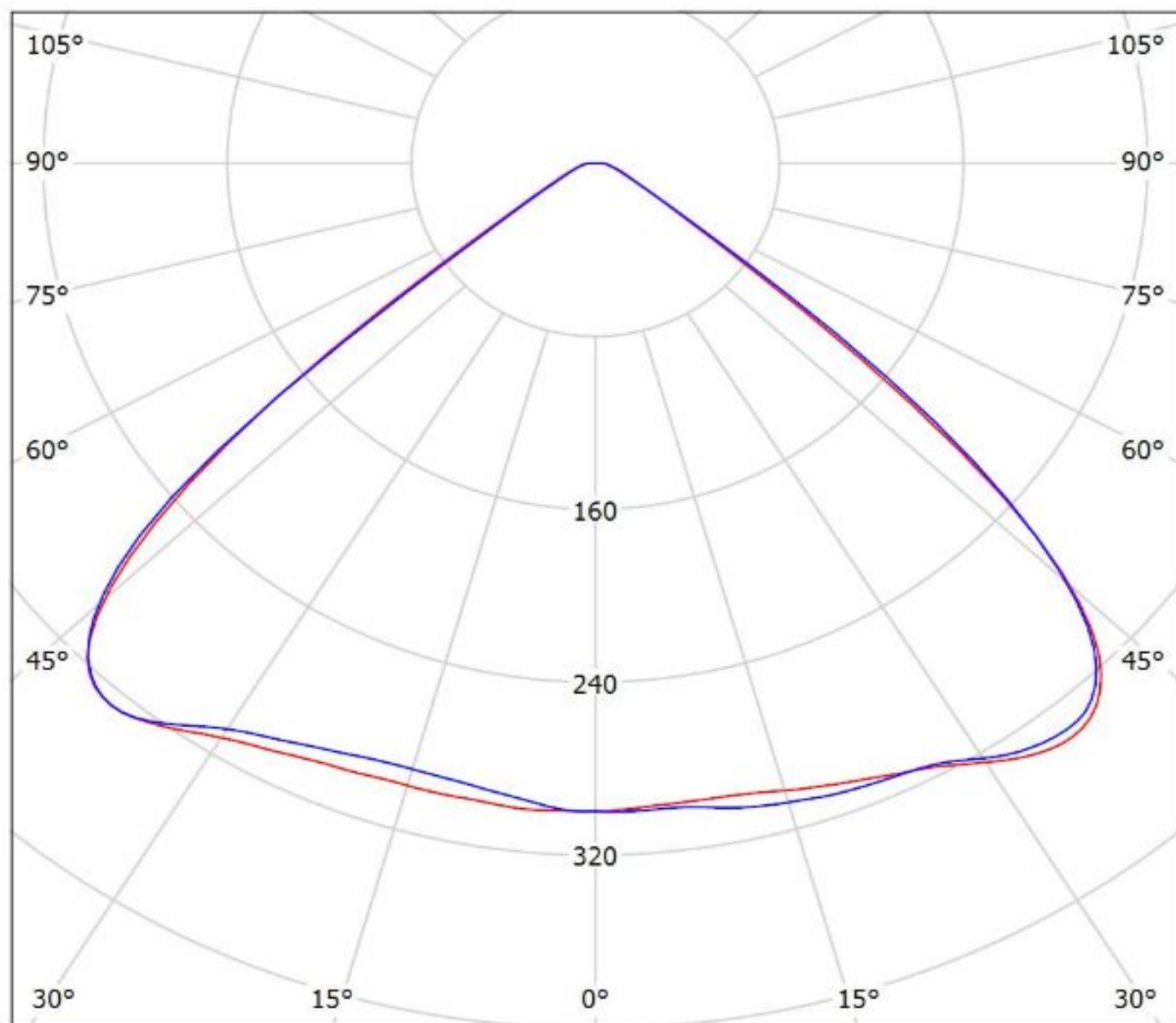

cd/klm

— C0 - C180 — C90 - C270

$\eta = 92\%$

Luminaire: LEDiL Oy FCN14648_JENNY-CY_(XM-L)

Lamps: 1 x CREE_XM-L_EZW_128.713lm@250mA_P=1.50385W_I=249.9mA

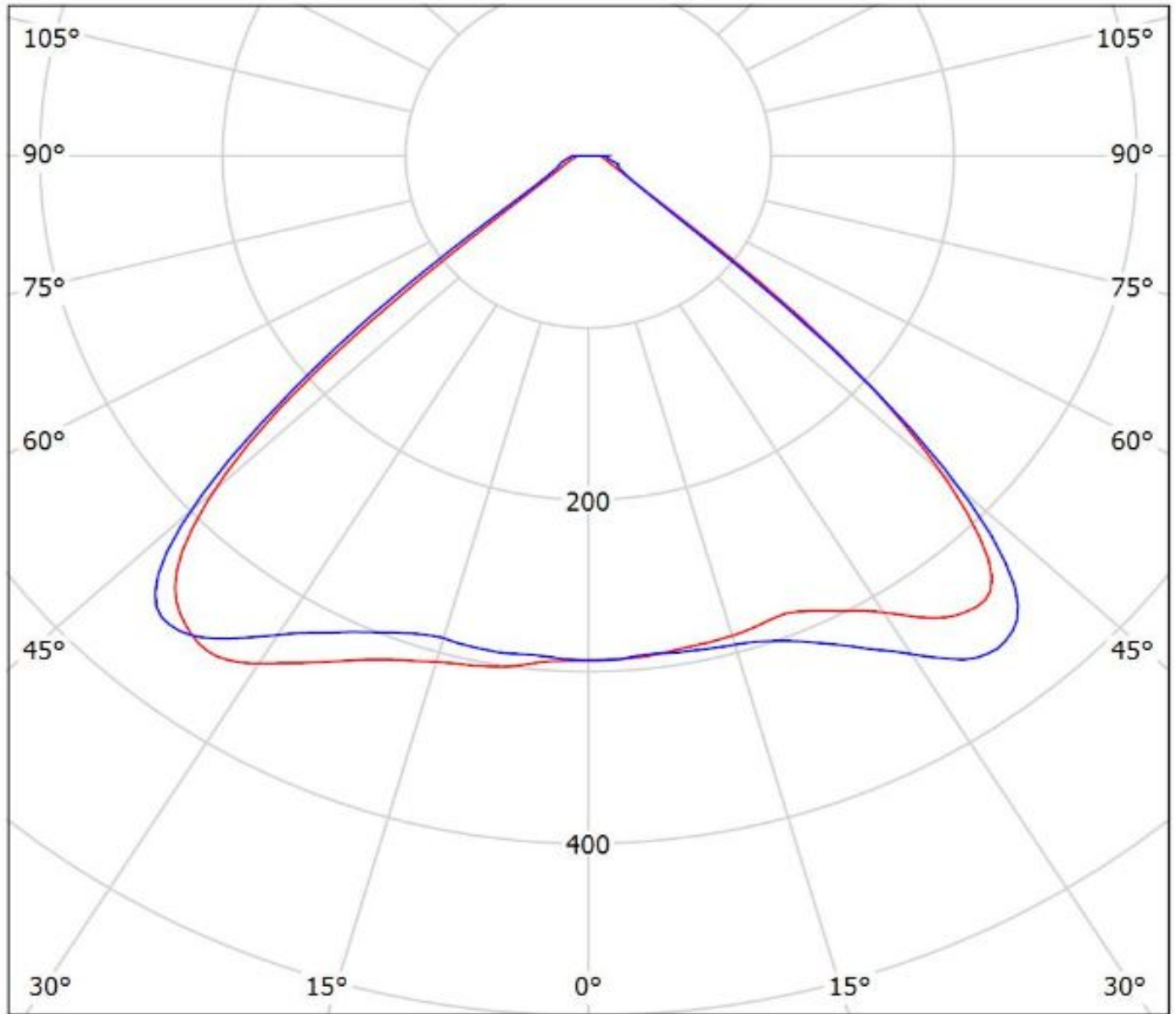

cd/klm

— C0 - C180

— C90 - C270

$\eta = 94\%$

Luminaire: Ledil FCN14648_JENNY-CY_(LUXEON_5258)

Lamps: 1 x LUXEON_5258_(24VOLTS)_307.573lm@100mA_CCT=2700K_P=?W_I=0.1A

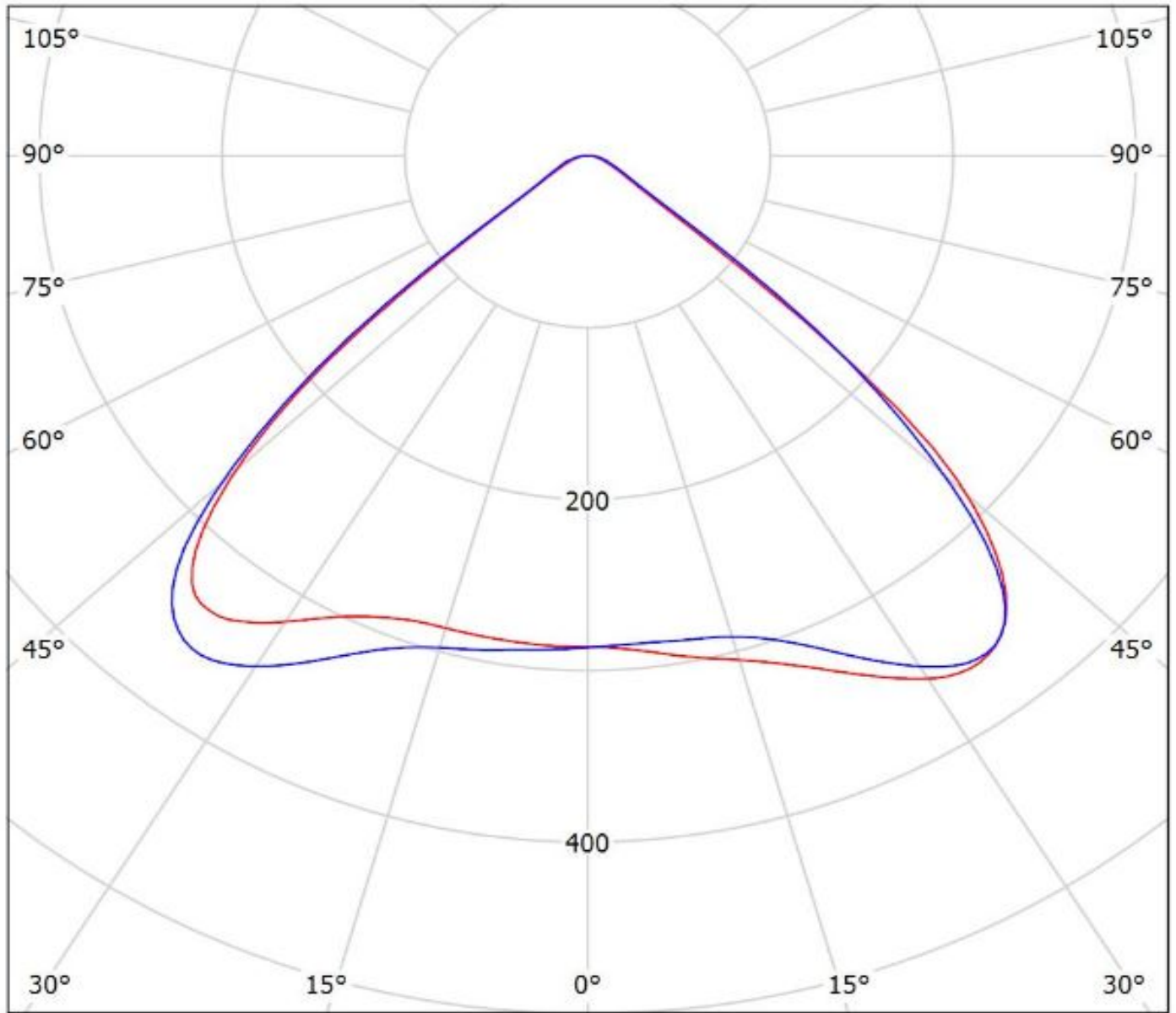

cd/klm

— C0 - C180 — C90 - C270

$\eta = 94\%$

Luminaire: LEDiL Oy FCN14648_JENNY-CY_(LUXEON_M)

Lamps: 1 x LUXEON_M_(LXR7-SW40)_318.732lm@250mA_P=2.72282W_I=249.8mA

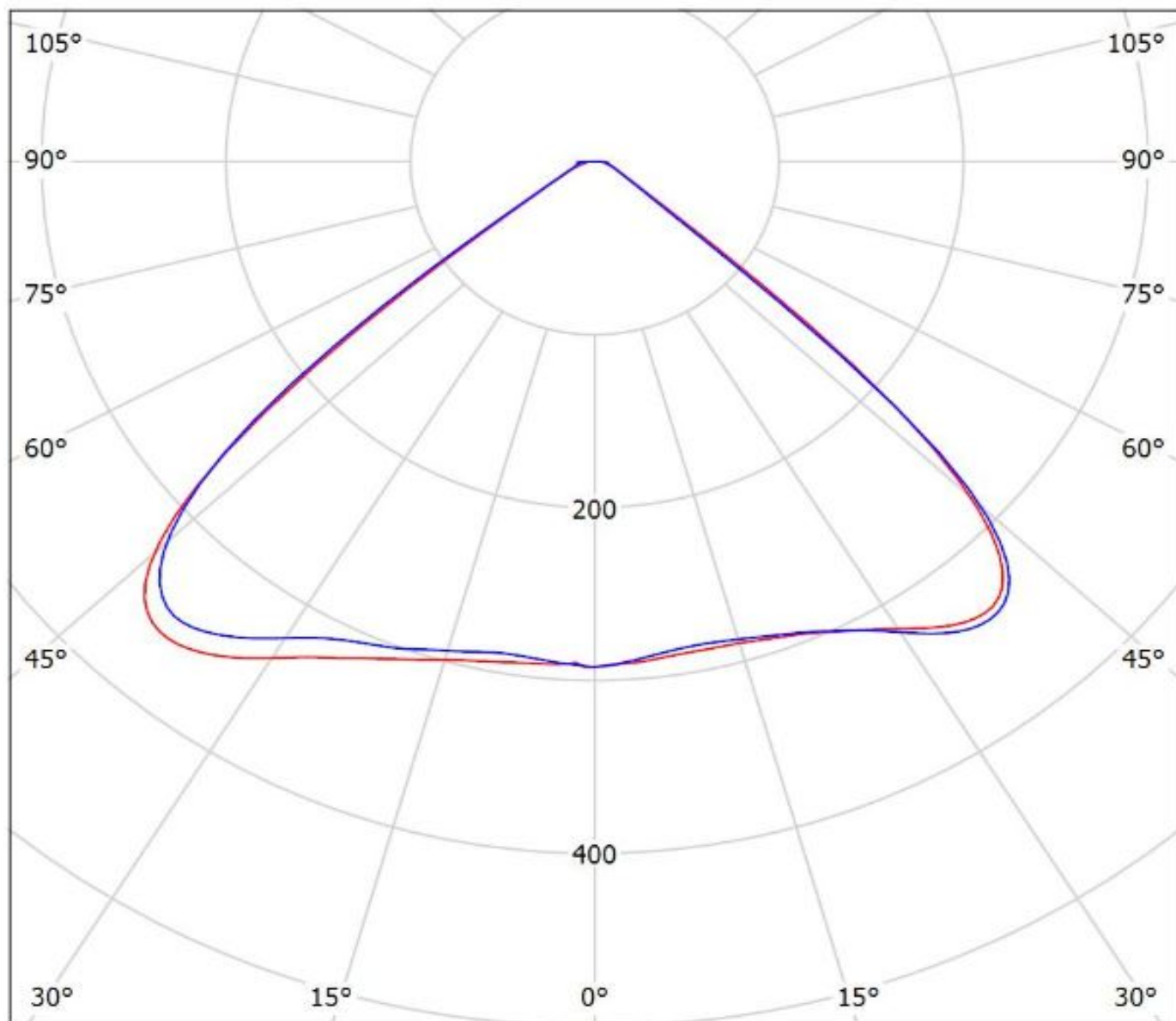

cd/klm

— C0 - C180 — C90 - C270

$\eta = 94\%$

Luminaire: LEDiL Oy FCN14648_JENNY-CY_(NSMx286M)

Lamps: 1 x NICHIA_NSMx286M_(NSML286ME)_335.4lm@100mA_P=3.43543W_I=100.1mA

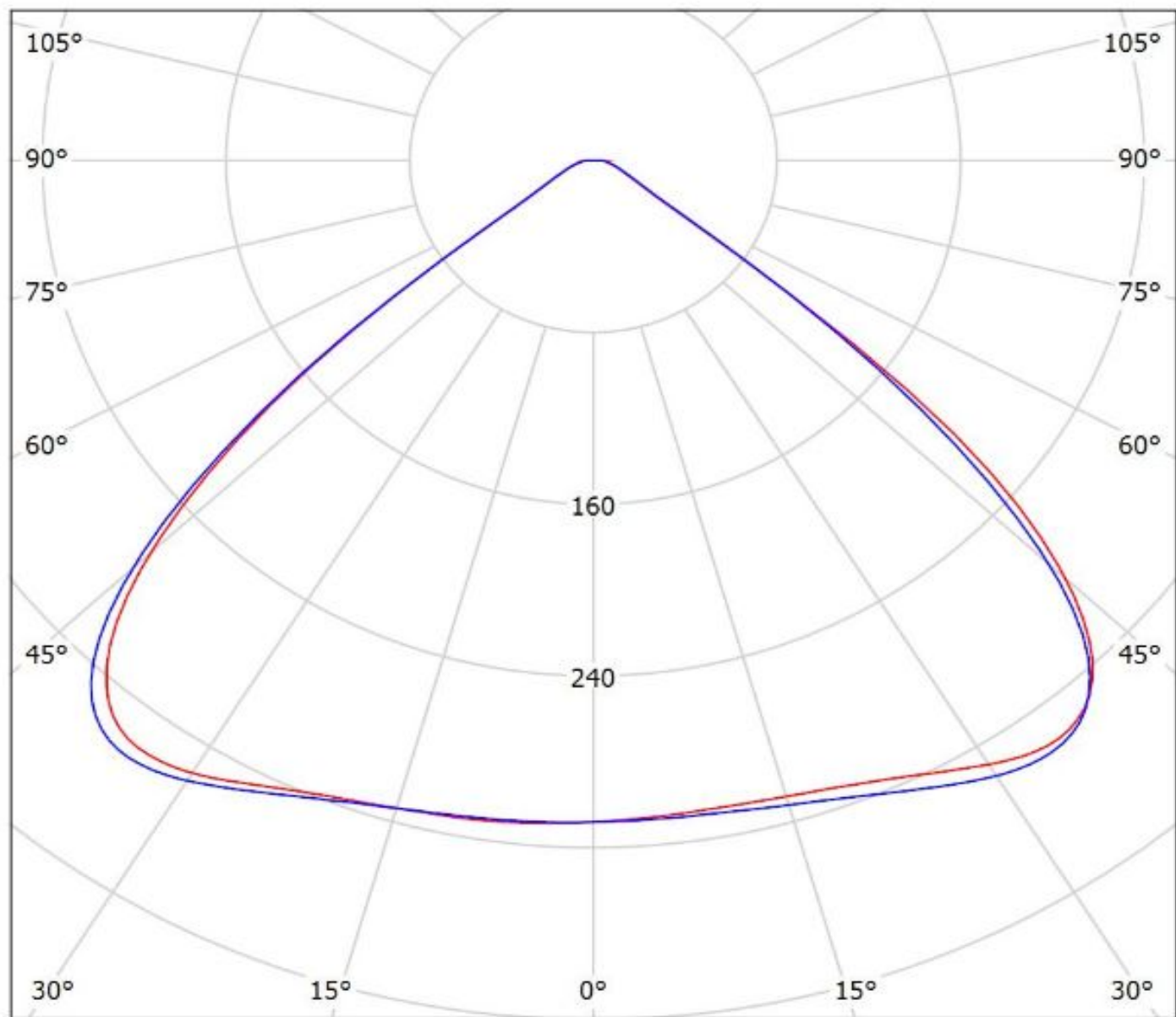

cd/klm

— C0 - C180

— C90 - C270

$\eta = 94\%$

Luminaire: LEDiL Oy FCN14648_JENNY-CY_(NV4x144A)

Lamps: 1 x Nichia_NV4x144A_477.334lm@250mA_P=2.8030W_I=0.250A

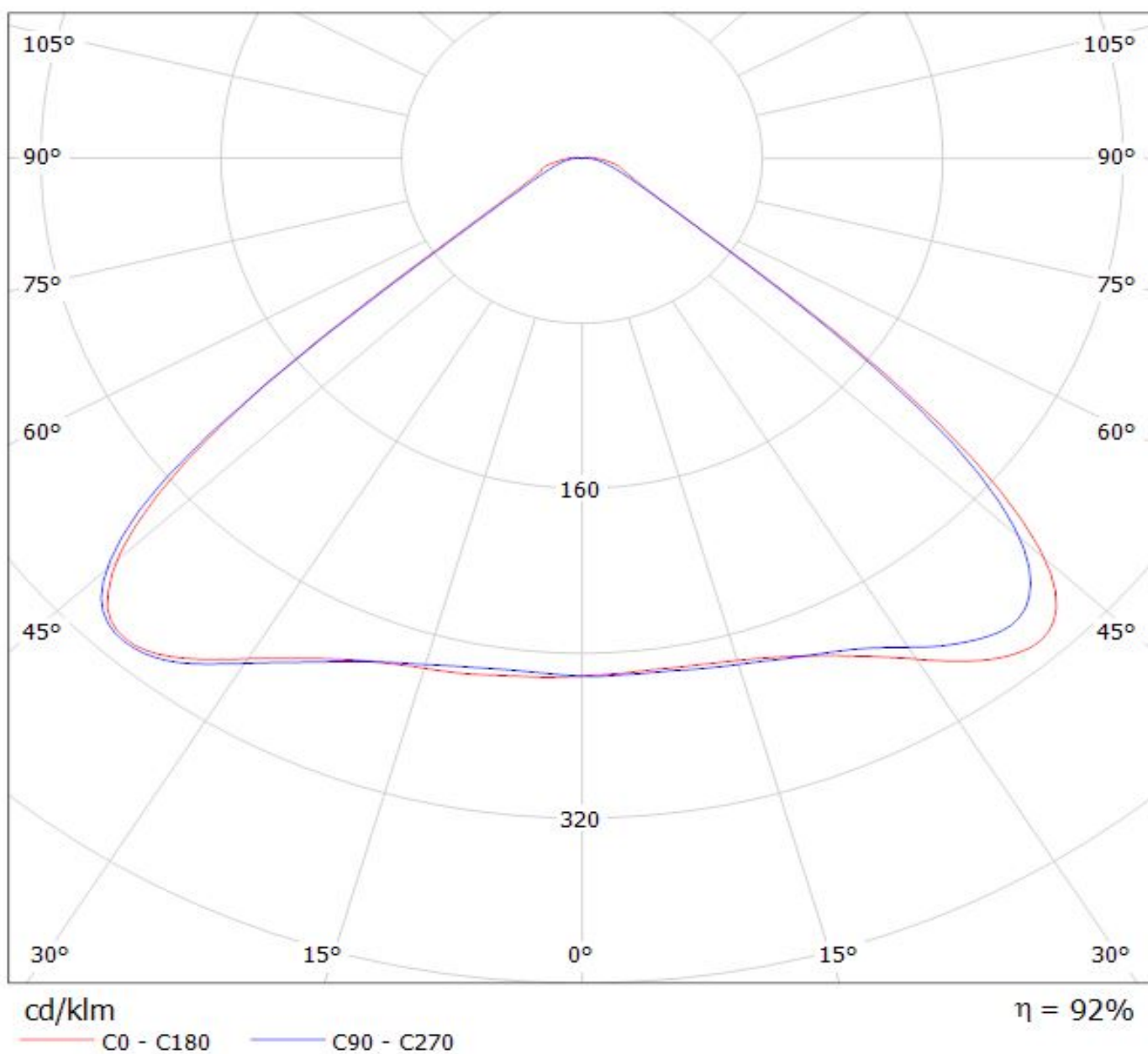

Luminaire: Ledil FCN14648_JENNY-CY_(Duris_S8)

Lamps: 1 x Osram_Duris_S8_(GW_P9LMS1.EC)_201.491lm@100mA_CCT=2857K_P=1.8W_I=0.1A

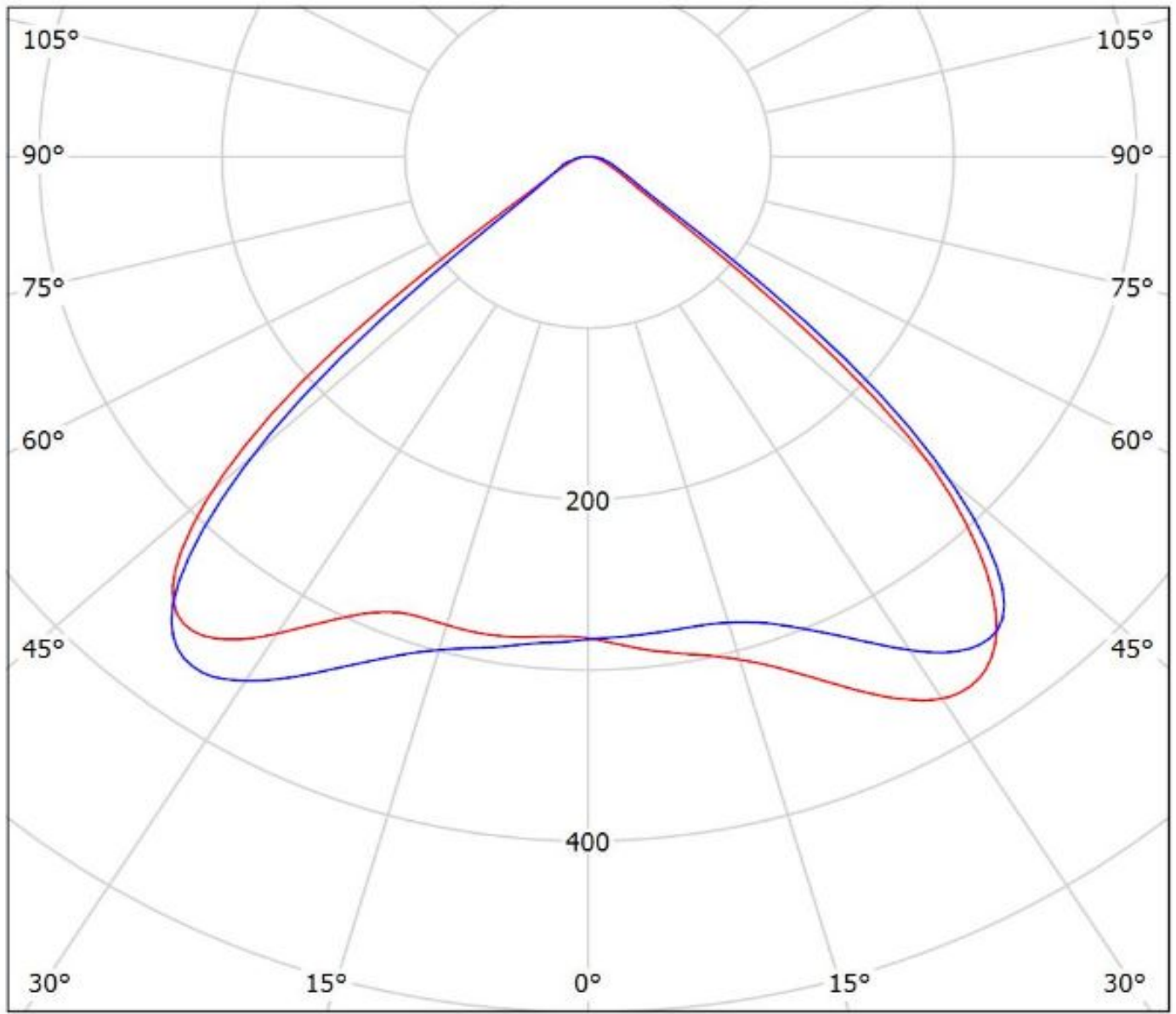

cd/klm

— C0 - C180 — C90 - C270

$\eta = 94\%$

Luminaire: Ledil Oy FCN14648_JENNY-CY_(Duris_S10)_SIMULATED
Lamps: 1 x Osram Duris S10 (GW P7LM32.EM)



cd/klm

— C0 - C180 — C90 - C270

$\eta = 96\%$

Luminaire: LEDiL Oy FCN14648_JENNY-CY_(P6)

Lamps: 1 x OSRAM_SOLERIQ_P6_(GW_MAFJB1.EM)_693.953lm@250mA_P=6.29348W_I=249.9mA

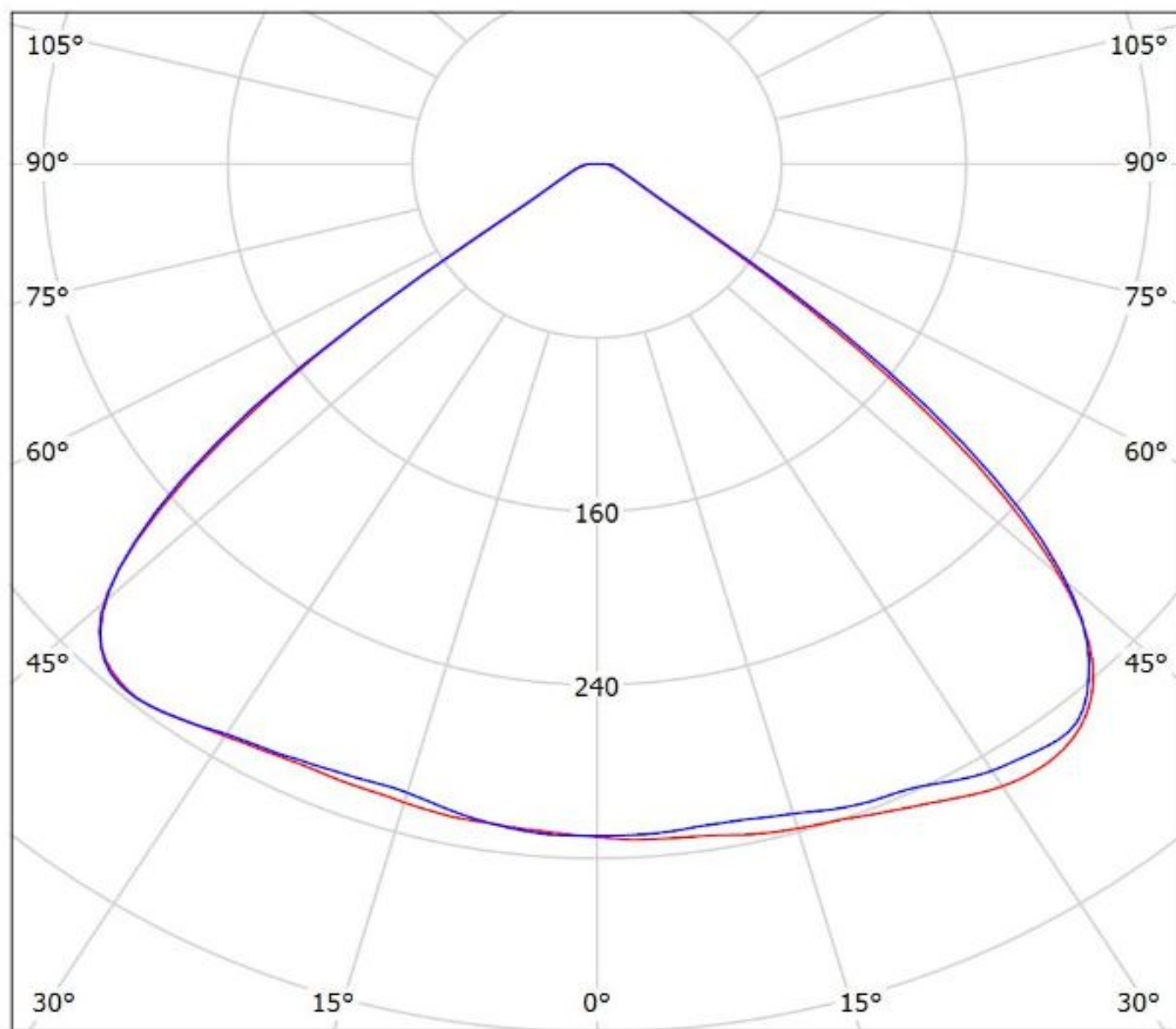

cd/klm

— C0 - C180 — C90 - C270

$\eta = 94\%$

Luminaire: LEDiL Oy FCN14648_JENNY-CY_(P9)

Lamps: 1 x OSRAM_SOLERIQ_P9_(GW_MAFJB1.EM)_911lm@250mA_P=6.90072W_I=249.8mA

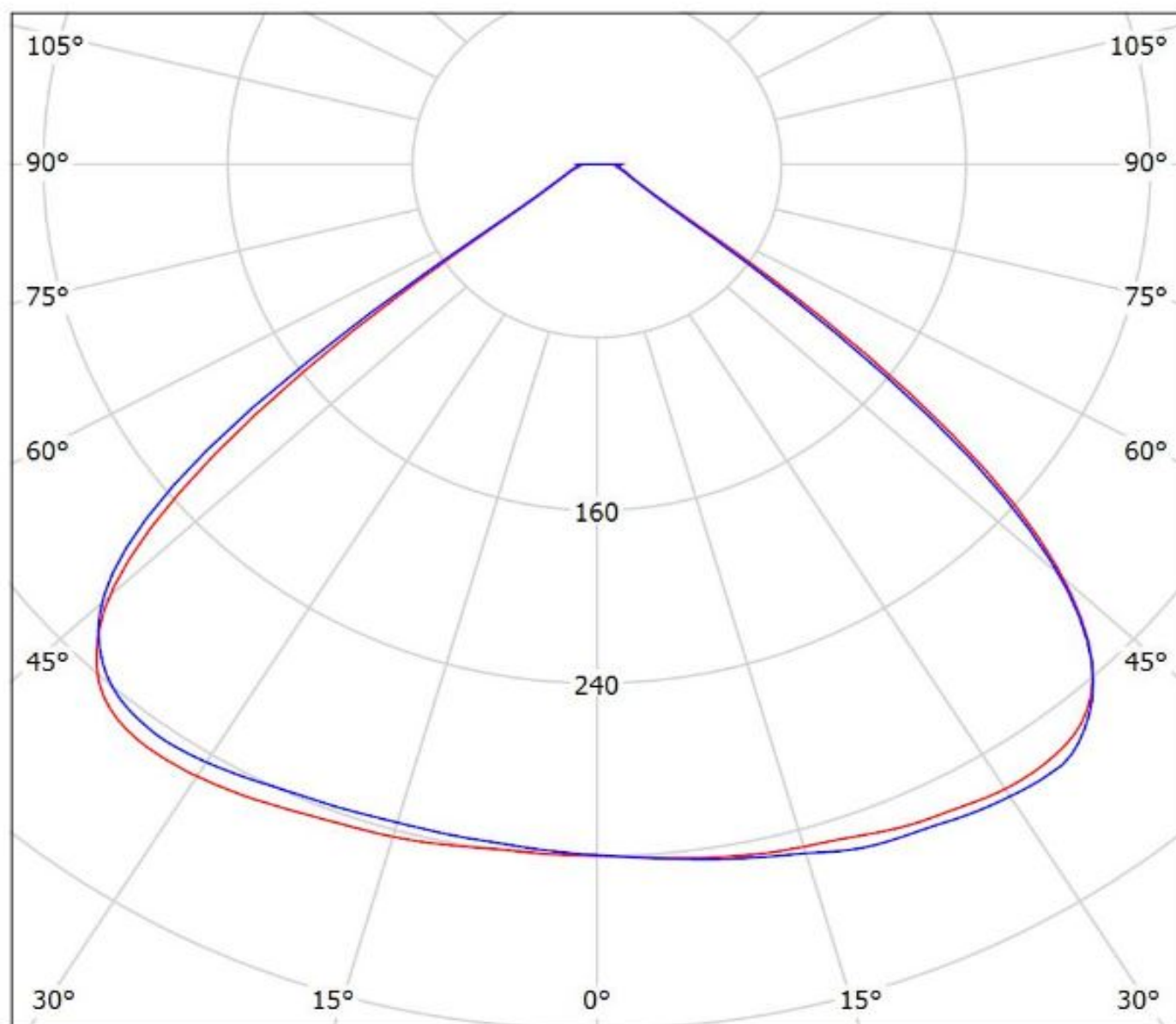

cd/klm

— C0 - C180

— C90 - C270

$\eta = 94\%$

Luminaire: LEDiL Oy FCN14648_JENNY-CY_(COB_D_LES_9.8mm)

Lamps: 1 x Samsung_COB_D_series_LES_9.8mm_LC013D_534.999lm@100mA_P=3.1948W_I=0.100A

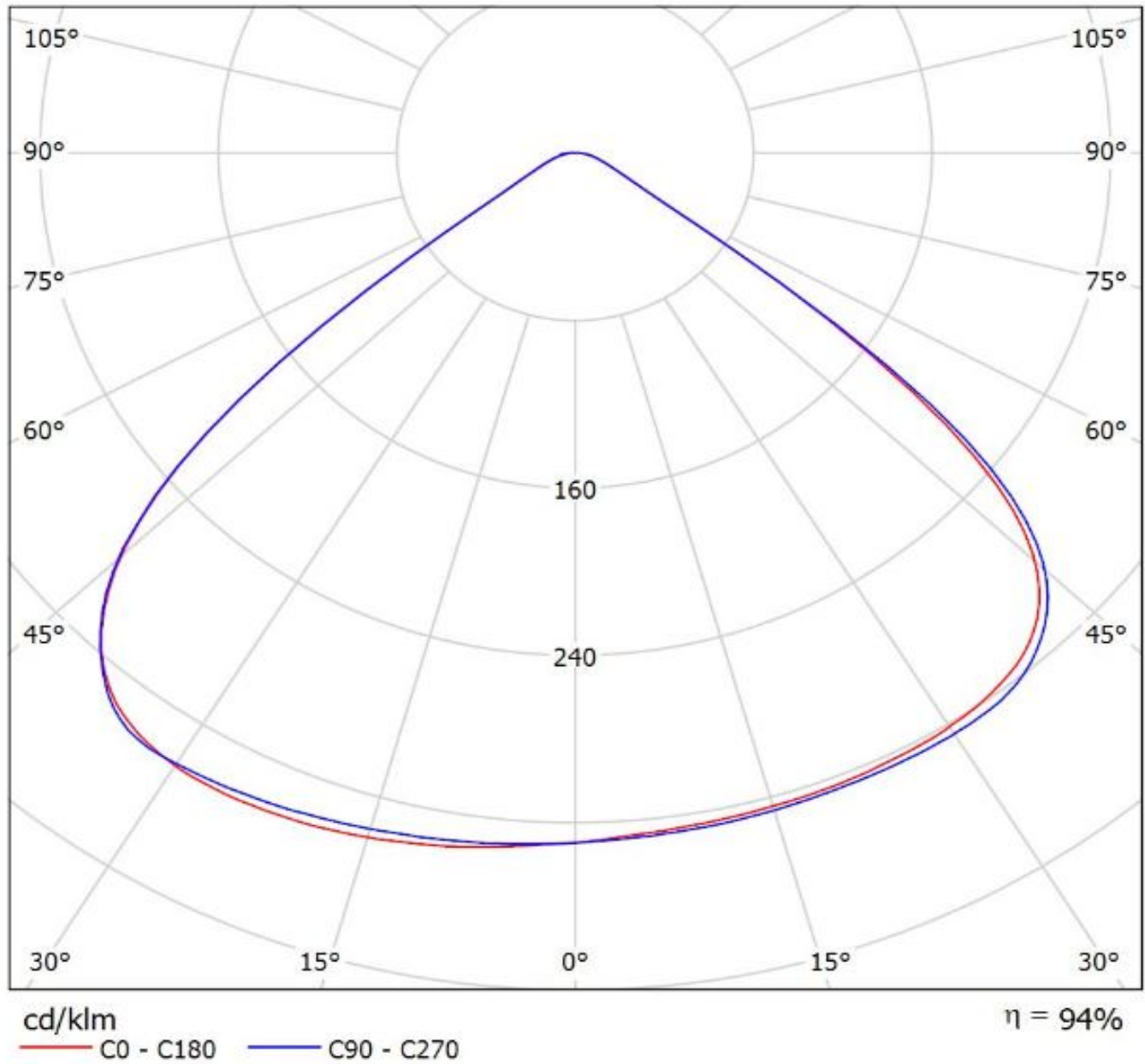

Luminaire: Ledil FCN14648_JENNY-CY_(MJT_12W_Les9,8)

Lamps: 1 x Seoul_MJT_12W_Les9.8mm_(SAWx1063A)_1245.58lm@250mA_P=8.30025W_I=0.25A

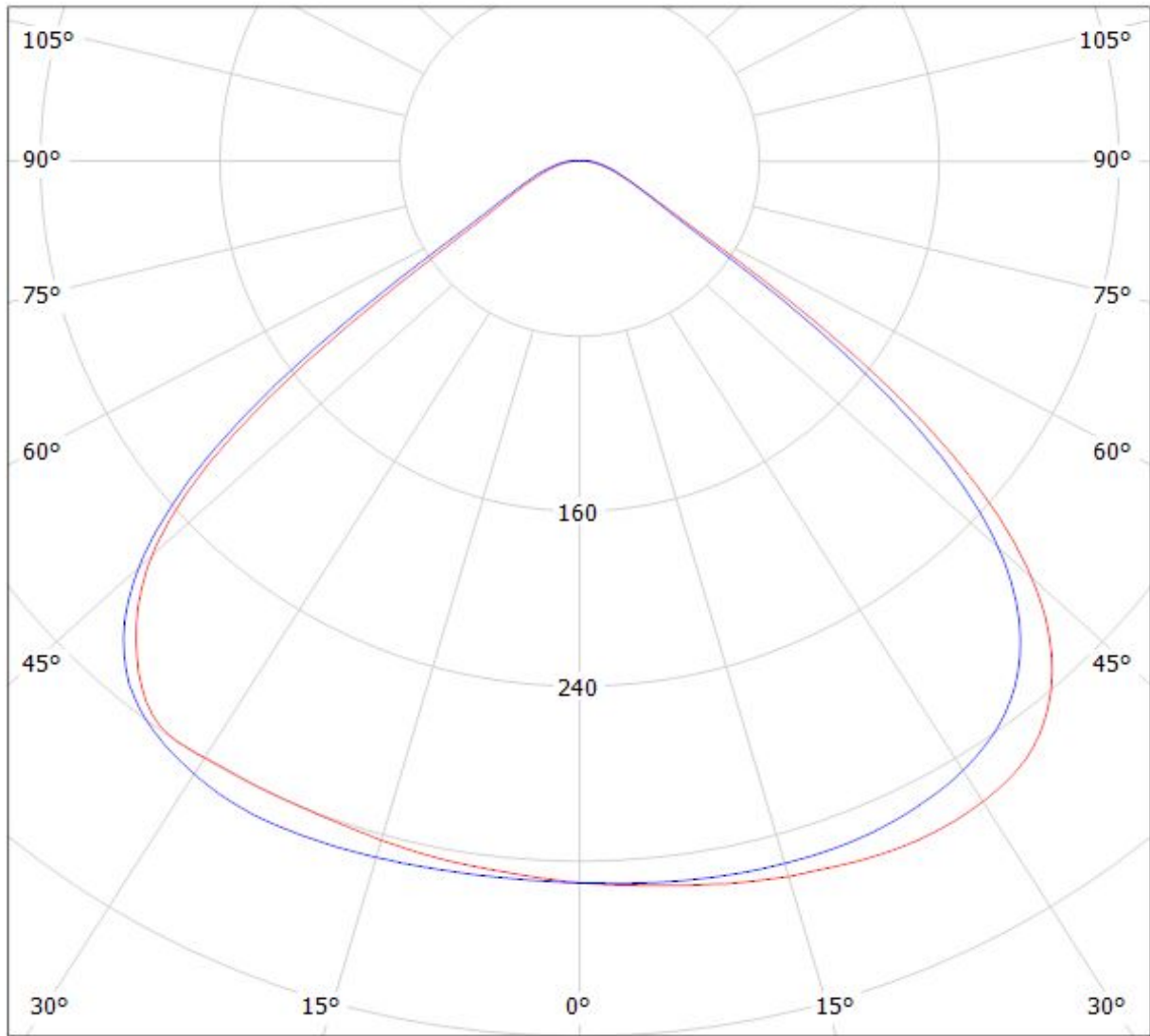

cd/klm

— C0 - C180

— C90 - C270

$\eta = 93\%$

Luminaire: Ledil FCN14648_JENNY-CY_(MJT_6W_Les6)

Lamps: 1 x Seoul_MJT_6W_Les6mm_(SAWx0661A)_820.711lm@180mA_P=6.3909W_I=0.18A

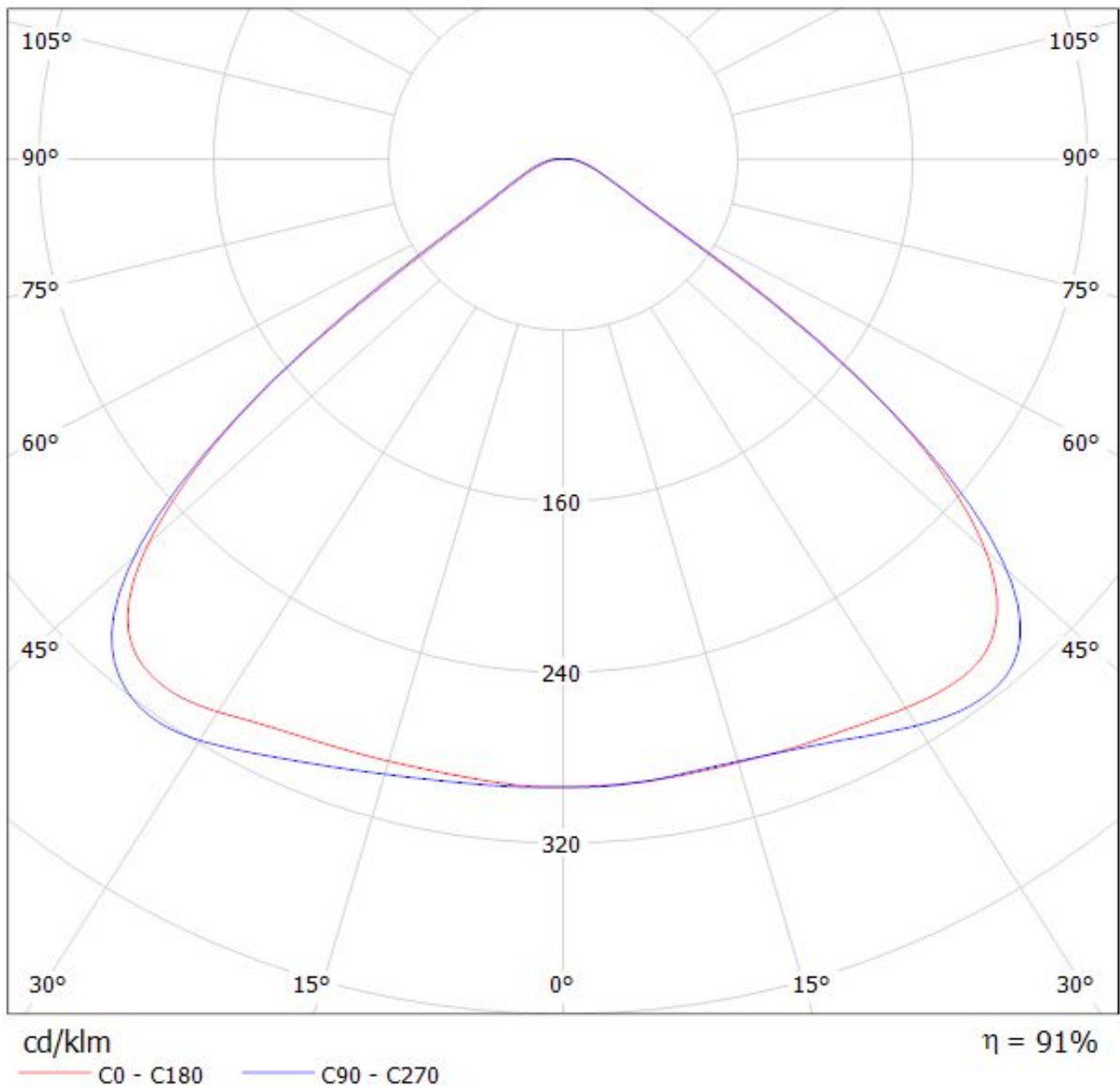

Luminaire: LEDiL Oy FCN14648_JENNY-CY_(SLE-G5_LES-6)

Lamps: 1 x Tridonic_SLE-G5_LES-6_470.842lm@100mA_P=3.3743W_I=0.100A

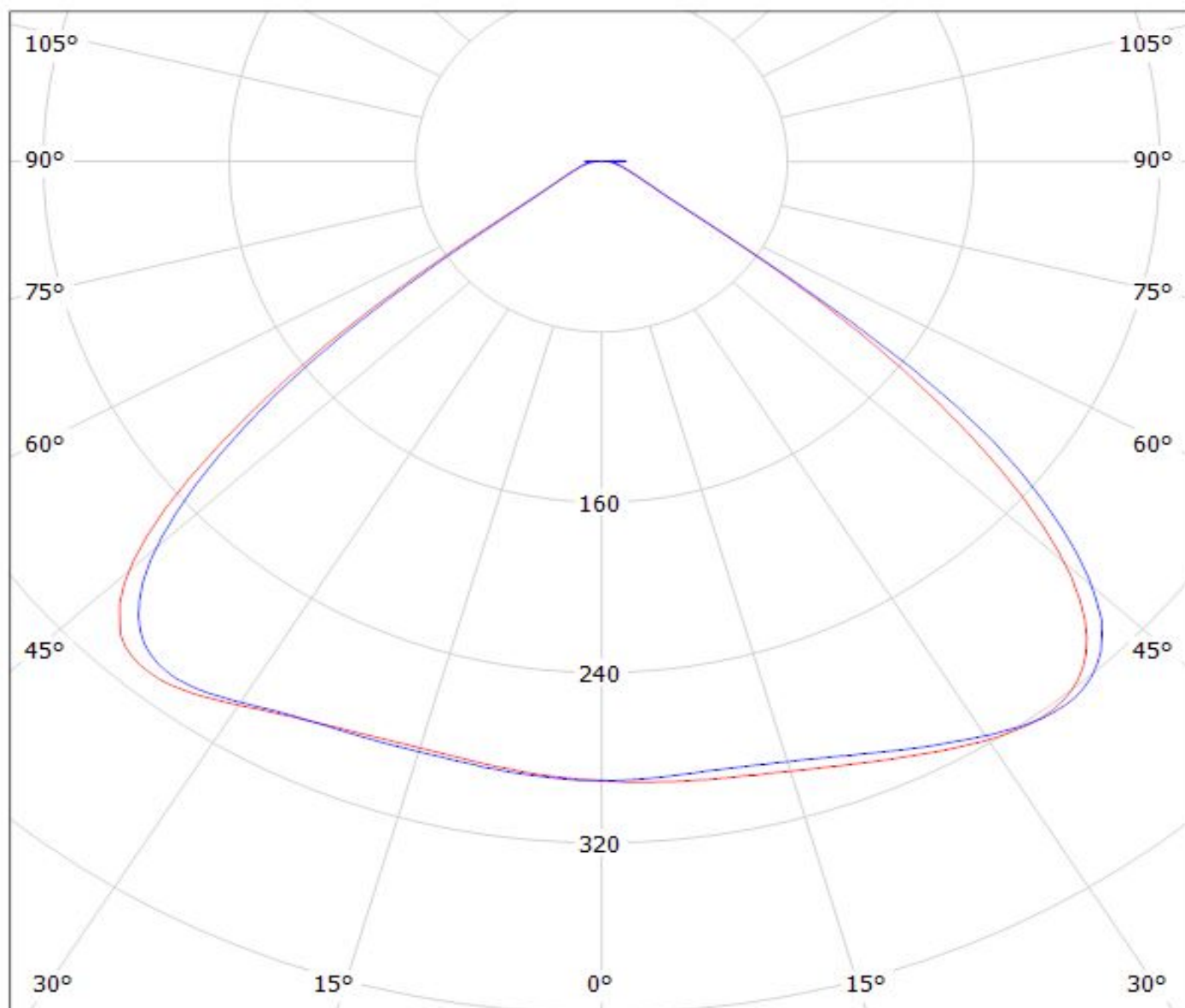

cd/klm

— C0 - C180 — C90 - C270

$\eta = 93\%$

Luminaire: LEDiL Oy FCN14648_JENNY-CY_(SLE-G5_LES-11)

Lamps: 1 x Tridonic_SLE-G5_LES-11_1186.5lm@250mA_P=8.3528W_η=0.250A

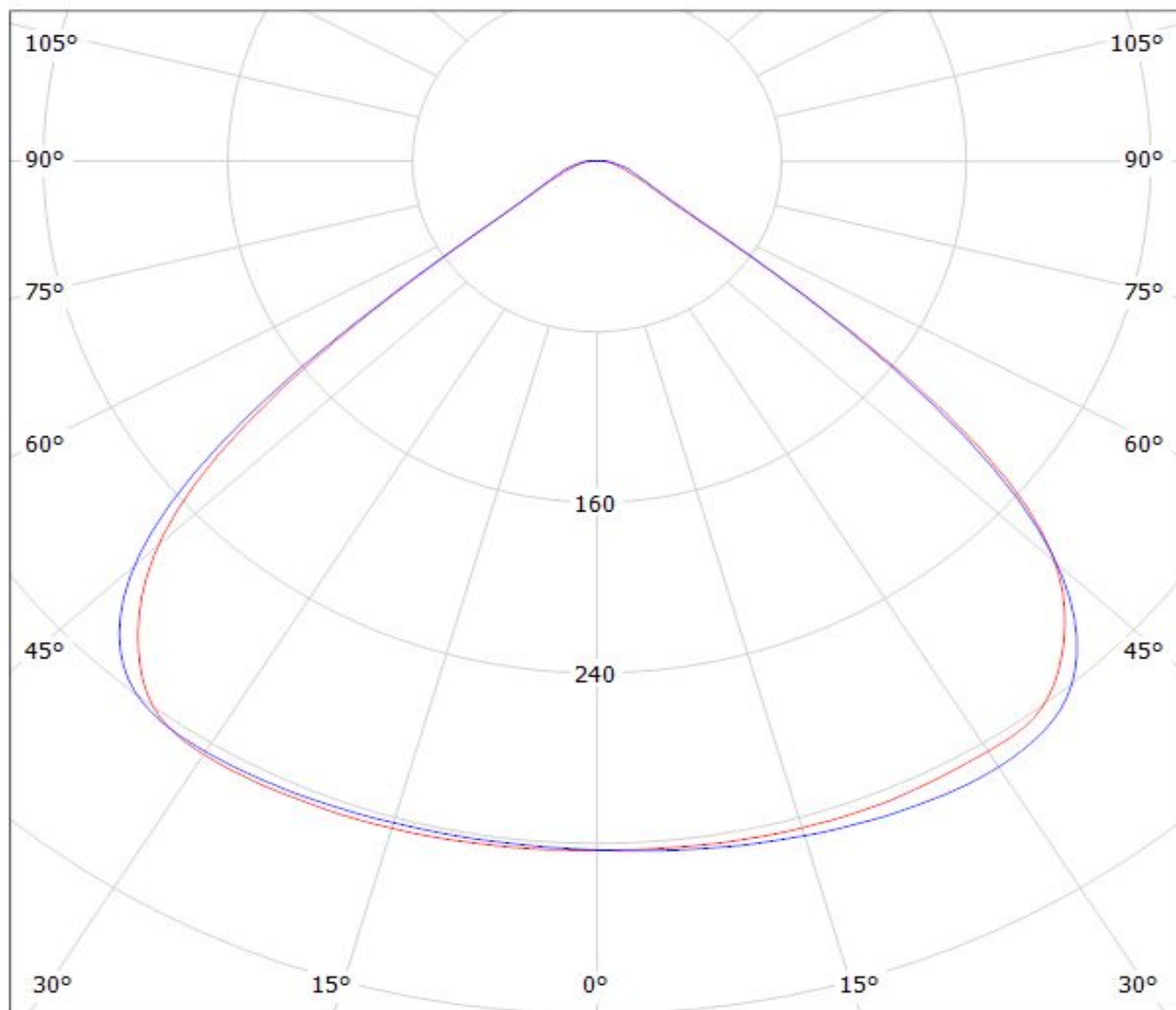

cd/klm

— C0 - C180

— C90 - C270

η = 91%

NOTE: The typical divergence will be changed by different color, chip size and chip position tolerance. The typical total divergence is the full angle measured where the luminous intensity is half of the peak value.

GENERAL INFORMATION

- Product series especially designed & optimized for series of LEDs.
- Special care taken to make light distribution as uniform as possible.

Note! Due to use of high power COB's with this product, special attention to proper thermal design is highly recommended. LEDiL has no liability for direct, indirect or consecutive damages arising from the LEDiL products being used outside of the recommended temperature range.