

1. PART NO. EXPRESSION :

Z 1 K 3 0 0 - R C - □ □
 (a)(b)(c) (d) (e)(f) (g)

- (a) Series code
- (b) Dimension code
- (c) Material code
- (d) Impedance code : 300 = 30.0Ω
- (e) R : Reel
- (f) Current : C = 300mA
- (g) 10: Standard
11 ~ 99 : Internal control number

2. CONFIGURATION & DIMENSIONS :

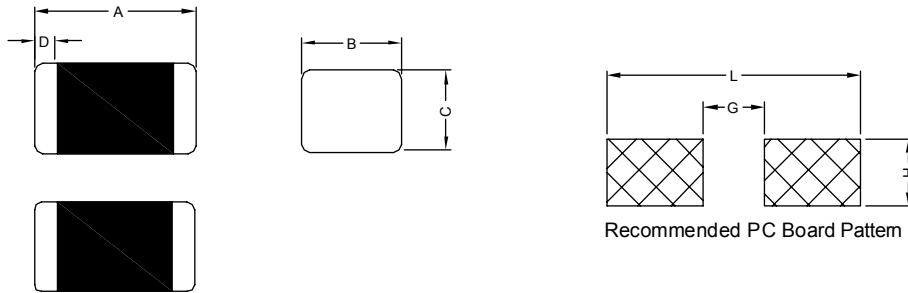

Recommended PC Board Pattern

Unit:m/m

A	B	C	D	G	H	L
1.00± 0.10	0.50± 0.10	0.50± 0.10	0.25± 0.10	0.40 Ref.	0.55 Ref.	1.50 Ref.

3. SCHEMATIC :

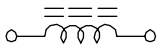

4. MATERIALS :

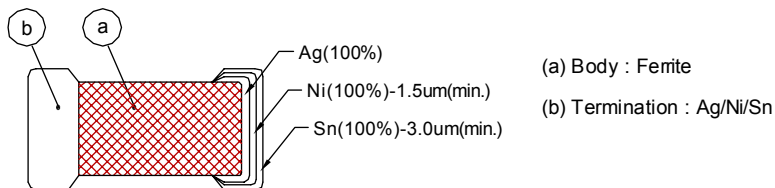

- (a) Body : Ferrite
- (b) Termination : Ag/Ni/Sn

5. GENERAL SPECIFICATION :

- a) Operating temp. : -40° C to +125° C (including self-temperature. rise)
- b) Storage condition (component in its packaging)
 - i) Temperature : -10 to 40° C
 - ii) Humidity : 60%



RoHS Compliant

NOTE : Specifications subject to change without notice. Please check our website for latest information.

19.01.2015

6. ELECTRICAL CHARACTERISTICS :

Part Number	Impedance (Ω)	Test Frequency (MHz)	DC Resistance (Ω) Max.	Rated Current (mA) Max.
Z1K300-RC-10	30 \pm 25%	100	0.20	300
Z1K600-RC-10	60 \pm 25%	100	0.25	300
Z1K121-RA-10	120 \pm 25%	100	0.30	100
Z1K151-RA-10	150 \pm 25%	100	0.30	100
Z1K221-RA-10	220 \pm 25%	100	0.40	100
Z1K301-RA-10	300 \pm 25%	100	0.50	100
Z1K471-RA-10	470 \pm 25%	100	0.65	100
Z1K601-RA-10	600 \pm 25%	100	0.80	80
Z1K102-RA-10	1000 \pm 25%	100	1.20	50
Z1M600-RA-10	60 \pm 25%	100	0.30	100
Z1M121-RA-10	120 \pm 25%	100	0.45	80
Z1M221-RA-10	220 \pm 25%	100	0.60	50
Z1M301-RA-10	300 \pm 25%	100	0.75	50



RoHS Compliant

NOTE : Specifications subject to change without notice. Please check our website for latest information.

19.01.2015



SUPERWORLD ELECTRONICS (S) PTE LTD

7. CHARACTERISTICS CURVES :

Z1K300-RC-10

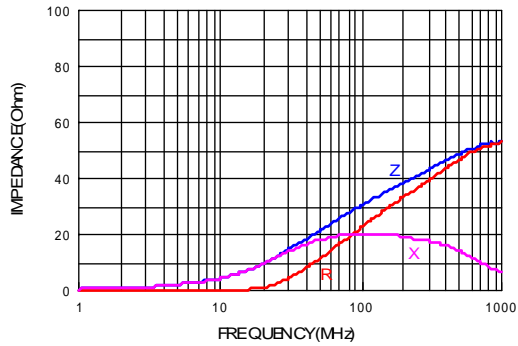

Z1K600-RC-10

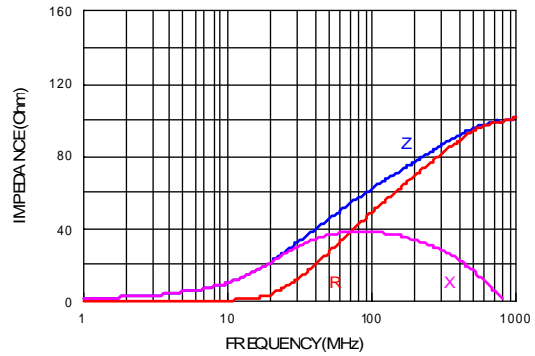

Z1K121-RA-10

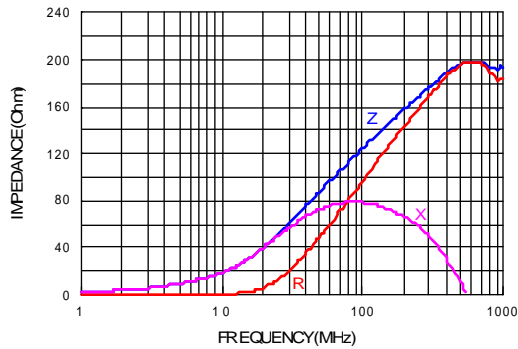

Z1K151-RA-10

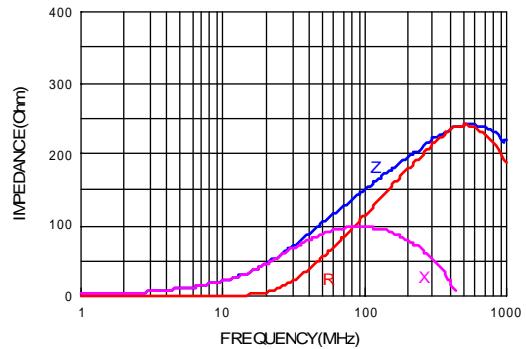

Z1K221-RA-10

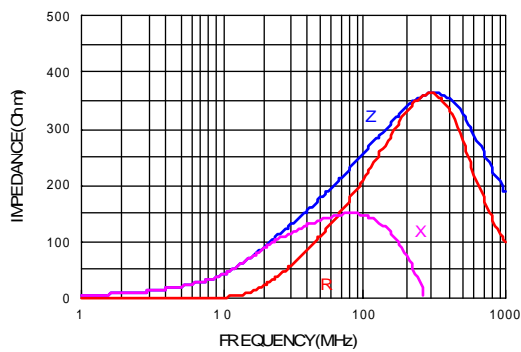

Z1K301-RA-10

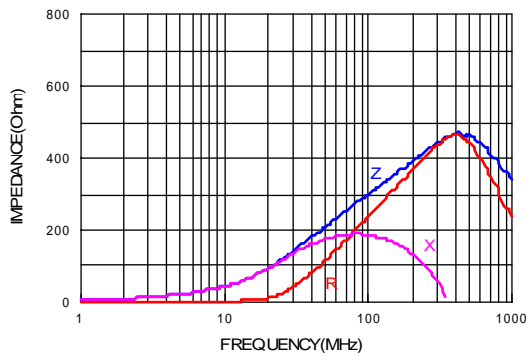

RoHS Compliant

NOTE : Specifications subject to change without notice. Please check our website for latest information.

19.01.2015



SUPERWORLD ELECTRONICS (S) PTE LTD

Z1K471-RA-10

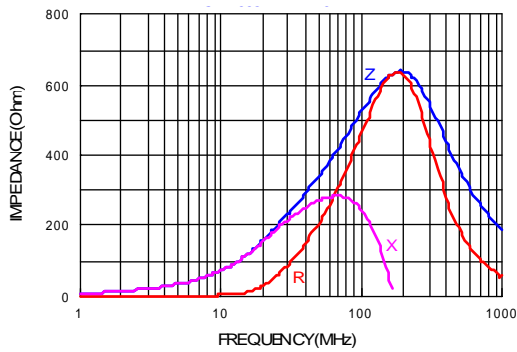

Z1K601-RA-10

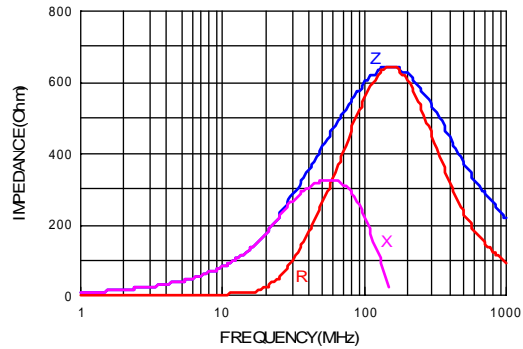

Z1K102-RA-10

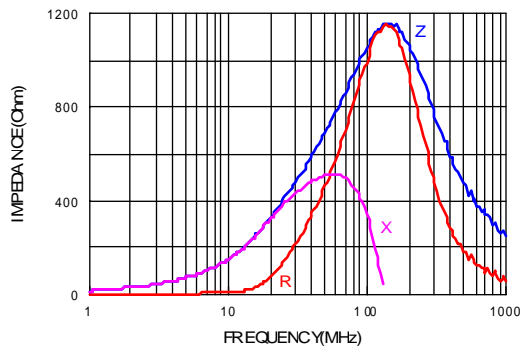

Z1M600-RA-10

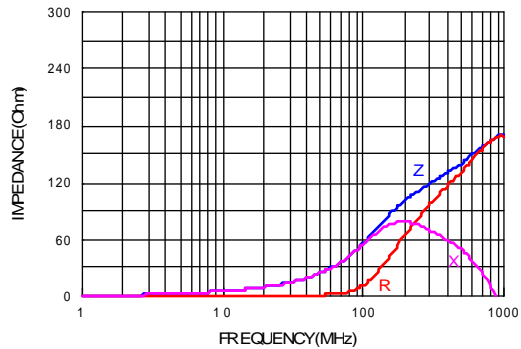

Z1M121-RA-10

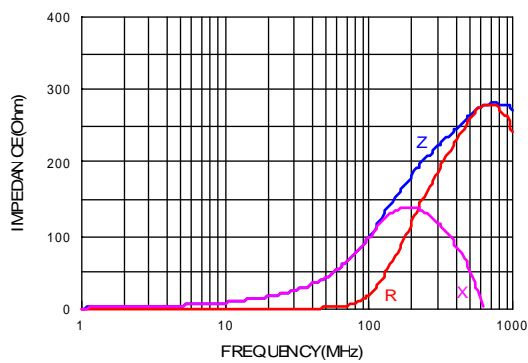

Z1M221-RA-10

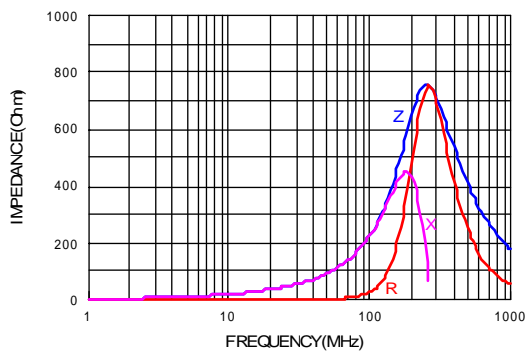

RoHS Compliant

NOTE : Specifications subject to change without notice. Please check our website for latest information.

19.01.2015



SUPERWORLD ELECTRONICS (S) PTE LTD

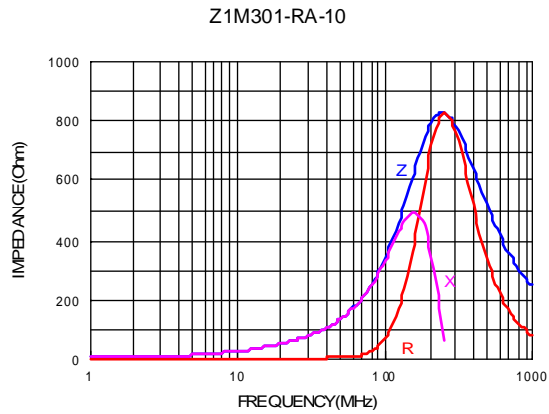

RoHS Compliant

NOTE : Specifications subject to change without notice. Please check our website for latest information.

19.01.2015



SUPERWORLD ELECTRONICS (S) PTE LTD

8. SOLDERING AND MOUNTING :

8-1. Recommended PC Board Pattern

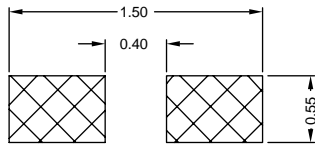

PC board should be designed so that products can prevent damage from mechanical stress when warping the board.

8-2. Soldering

Mildly activated rosin fluxes are preferred. The terminations are suitable for re-flow soldering systems. If hand soldering cannot be avoided, the preferred technique is the utilization of hot air soldering tools.

Note.

If wave soldering is used, there will be some risk.

Re-flow soldering temperatures below 240 degrees, there will be non-wetting risk

8-2.1 Lead Free Solder Re-flow :

Recommended temperature profiles for lead free re-flow soldering in Figure 1. (Referred to J-STD-020C)

8-2.2 Soldering Iron :

Products attachment with a soldering iron is discouraged due to the inherent process control limitations. If a soldering iron must be employed the following precautions are recommended. for Iron Soldering in Figure 2.

Note :

- a) Preheat circuit and products to 150° C.
- b) 350° C tip temperature for Ferrite chip bead (max)
- c) Never contact the ceramic with the iron tip
- d) 1.0mm tip diameter (max)
- e) Use a 20 watt soldering iron with tip diameter of 1.0mm
- f) Limit soldering time to 4-5 secs.

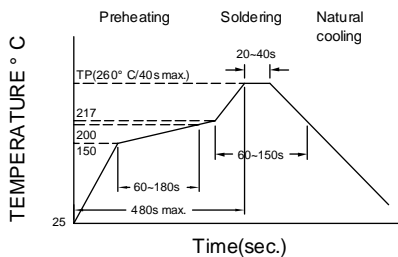

Figure 1. Re-flow Soldering:3 times max

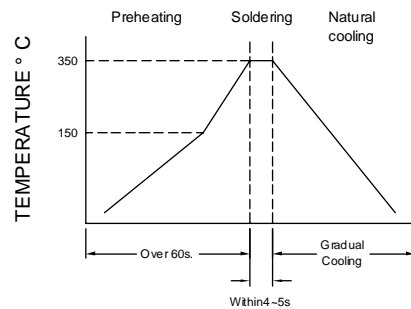

Figure 2. Wave Soldering:1 times max



RoHS Compliant

NOTE : Specifications subject to change without notice. Please check our website for latest information.



SUPERWORLD ELECTRONICS (S) PTE LTD

19.01.2015

8-3. Solder Volume

Accordingly increasing the solder volume, the mechanical stress to product is also increased. Exceeding solder volume may cause the failure of mechanical or electrical performance. Solder shall be used not to be exceed as shown in Fig. 3.

Minimum fillet height = soldering thickness + 25% product height

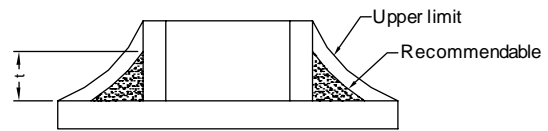

Figure 3



RoHS Compliant

NOTE : Specifications subject to change without notice. Please check our website for latest information.

19.01.2015



SUPERWORLD ELECTRONICS (S) PTE LTD

PG. 7

9. PACKAGING INFORMATION :

9-1. Reel Dimension

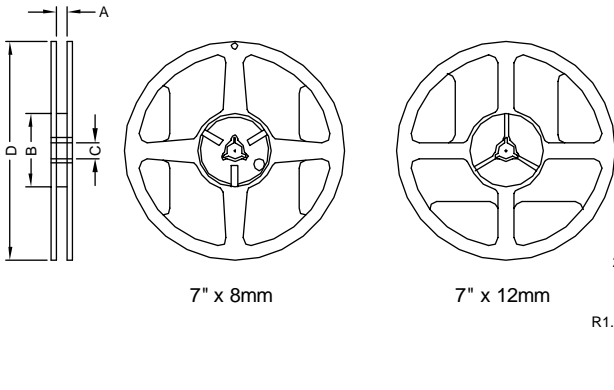

Type	A(mm)	B(mm)	C(mm)	D(mm)
7" x 8mm	9.0±0.5	60.0±2.0	13.5±0.5	178.0±2.0
7" x 12mm	13.5±0.5	60.0±2.0	13.5±0.5	178.0±2.0

9-2.1 Tape Dimension / 8mm

Material of taping is paper

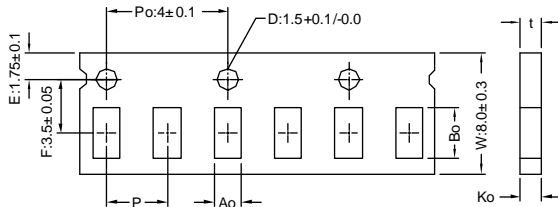

Size	Bo(mm)	Ao(mm)	Ko(mm)	P(mm)	t(mm)
0	0.68± 0.05	0.38± 0.05	0.50max	2.0± 0.05	0.50max

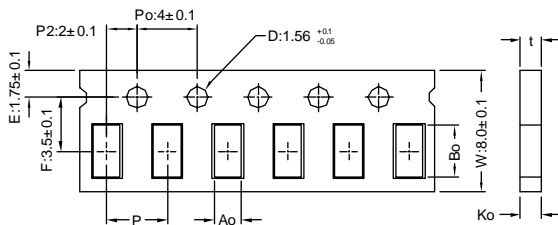

Size	Bo(mm)	Ao(mm)	Ko(mm)	P(mm)	t(mm)
1	1.12± 0.03	0.62± 0.03	0.60± 0.03	2.0± 0.10	0.60± 0.03
2	1.85± 0.05	1.05± 0.05	0.95± 0.05	4.0± 0.10	0.95± 0.05
3(09)	2.30± 0.05	1.50± 0.05	0.95± 0.05	4.0± 0.10	0.95± 0.05

Material of taping is plastic

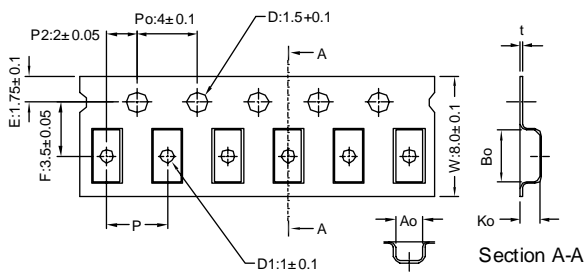

Size	Bo(mm)	Ao(mm)	Ko(mm)	P(mm)	t(mm)	D1(mm)
2(08)	1.95± 0.10	1.05± 0.10	1.05± 0.10	4.0± 0.10	0.23± 0.05	none
3(09)	2.25± 0.10	1.42± 0.10	1.04± 0.10	4.0± 0.10	0.22± 0.05	1.0± 0.10
3(12)	2.35± 0.10	1.50± 0.10	1.45± 0.10	4.0± 0.10	0.22± 0.05	1.0± 0.10
4(11)	3.50± 0.10	1.88± 0.10	1.27± 0.10	4.0± 0.10	0.22± 0.05	1.0± 0.10
5	3.42± 0.10	2.77± 0.10	1.55± 0.10	4.0± 0.10	0.22± 0.05	1.0± 0.10
4(09)	3.40± 0.10	1.77± 0.10	1.04± 0.10	4.0± 0.10	0.22± 0.05	1.0± 0.10



RoHS Compliant

NOTE : Specifications subject to change without notice. Please check our website for latest information.



9-2.2 Tape Dimension / 12mm

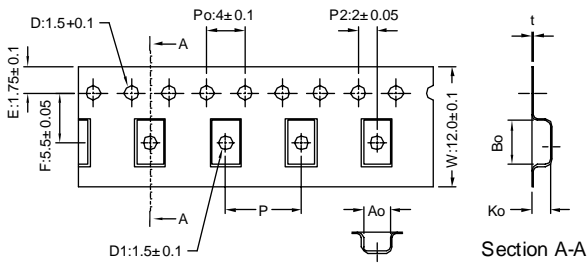

Series	Size	Bo(mm)	Ao(mm)	Ko(mm)	P(mm)	t(mm)	D1(mm)
Z / L	6	4.95±0.1	1.93±0.1	1.93±0.1	4.0±0.1	0.24±0.05	1.5±0.1
	7	4.95±0.1	3.66±0.1	1.85±0.1	8.0±0.1	0.24±0.05	1.5±0.1

9-3. Packaging Quantity

Chip Size	7	6	5	4(11)	4(09)	3(12)	3(09)	2	1	0
Chip / Reel	1000	2000	2500	3000	3000	2000	4000	4000	10000	15000
Inner Box	4000	8000	12500	15000	15000	10000	20000	20000	50000	75000
Middle Box	20000	40000	62500	75000	75000	50000	100000	100000	250000	375000
Carton	40000	80000	125000	150000	150000	100000	200000	200000	500000	750000

9-4. Tearing Off Force

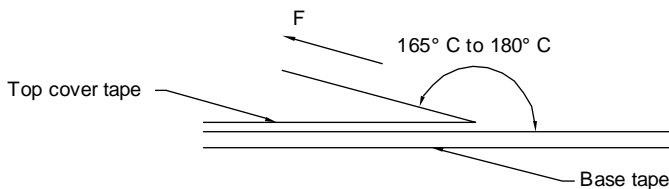

The force for tearing off cover tape is 15 to 60 grams in the arrow direction under the following conditions.

Room Temp. (° C)	Room Humidity (%)	Room atm (hPa)	Tearing Speed (mm/min)
5~35	45~85	860~1060	300

Application Notice

1. Storage Conditions :

To maintain the solderability of terminal electrodes :

- Recommended products should be used within 12 months from the time of delivery.
- The packaging material should be kept where no chlorine or sulfur exists in the air.

2. Transportation :

- Products should be handled with care to avoid damage or contamination from perspiration and skin oils.
- The use of tweezers or vacuum pick up is strongly recommended for individual components.
- Bulk handling should ensure that abrasion and mechanical shock are minimized.



RoHS Compliant

NOTE : Specifications subject to change without notice. Please check our website for latest information.

