

FEATURES :

- 2:1 Wide Input Voltages Range
- 16PIN SMD Package
- High Efficiency up to 83%
- Regulated Output Types
- Internal SMD Construction
- No External Component Required
- Operating Temperature:-40°C TO +85°C
- Industry Standard Pinout

Specifications typical at TA=25°C, nominal input voltage and rated output current unless otherwise specified

Part Number	Input Voltage Range	Output Voltage	Output Current	Efficiency
	Vdc	Vdc	mA	%TYP
28D-05S03R1W	4.5-9	3.3	303	68
28D-05S05R1W	4.5-9	5	200	71
28D-05S12R1W	4.5-9	12	84	73
28D-05S15R1W	4.5-9	15	67	71
28D-05D05R1W	4.5-9	±5	±100	68
28D-05D12R1W	4.5-9	±12	±42	70
28D-05D15R1W	4.5-9	±15	±34	71
28D-12S03R1W	9-18	3.3	303	71
28D-12S05R1W	9-18	5	200	75
28D-12S12R1W	9-18	12	84	78
28D-12S15R1W	9-18	15	67	78
28D-12D05R1W	9-18	±5	±100	71
28D-12D12R1W	9-18	±12	±42	78
28D-12D15R1W	9-18	±15	±34	76
28D-24S03R1W	18-36	3.3	303	71
28D-24S05R1W	18-36	5	200	78
28D-24S12R1W	18-36	12	84	82
28D-24S15R1W	18-36	15	67	83
28D-24D05R1W	18-36	±5	±100	74
28D-24D12R1W	18-36	±12	±42	78
28D-24D15R1W	18-36	±15	±34	80
28D-48S03R1W	36-75	3.3	303	70
28D-48S05R1W	36-75	5	200	74
28D-48S12R1W	36-75	12	84	80
28D-48S15R1W	36-75	15	67	80
28D-48D05R1W	36-75	±5	±100	74
28D-48D12R1W	36-75	±12	±42	77
28D-48D15R1W	36-75	±15	±34	78

Input Specifications

Parameters	Conditions	Min	Typ	Max	Units
Voltage Tolerance	Vo, Io Nom			2:1	
Filter	Capacitor				

YUAN DEAN SCIENTIFIC



DC-DC Converter

28D-1W SERIES

1Watt 1.5KV Isolated

2 : 1 Input Voltage Range

Single & Dual Output

SMD



Temperature Derating Graph

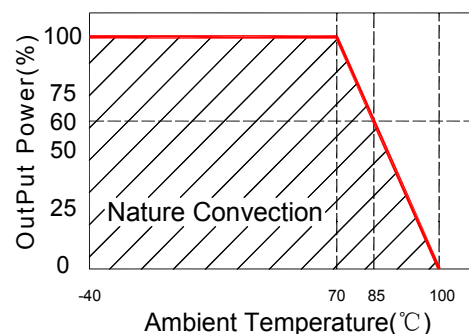

Output Specifications

Parameters	Conditions	Min	Typ	Max	Units
Voltage Tolerance	100% full load			±2	%
Short Circuit Protection	Continuous				
Line Regulation	Regulated			±0.5	%
Load Regulation	Regulated			±0.8	%
Ripple & Noise	BW=DC To 20MHz			100	mVp-p
Transient response setting time	50% load step change		350		us

General Specifications

Parameters	Conditions	Min	Typ	Max	Units
Isolation Resistance	500Vdc	1000			MΩ
Switching Frequency	Full load, nominal input		100		KHz
Operating Temperature		-40		+85	°C
Humidity	Non Condensing			95	%
Cooling	Free air Convection				
Case material	DAP				
MTBF	MIL-HDBK-217F@25°C	1000000			Hours
Weight			3.9		g
Dimensions			24.1x14.35x10.25		mm

Markings and dimensions

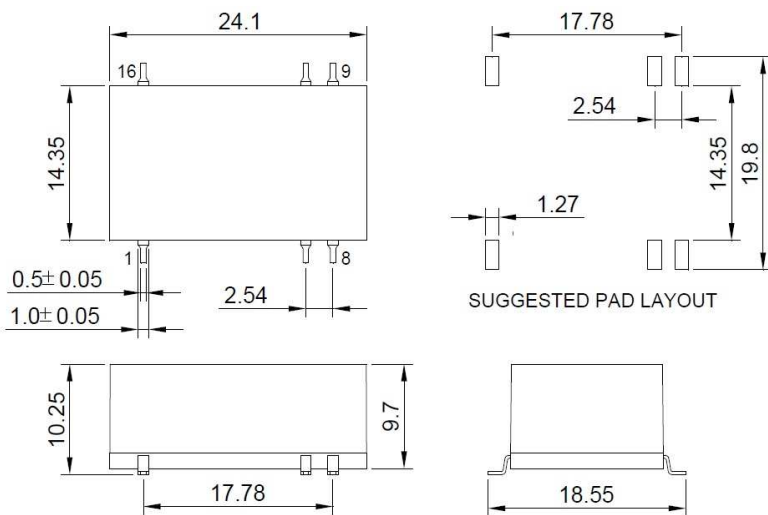

UNIT:mm Unless otherwise specified,all tolerances are ±0.25

Part Number

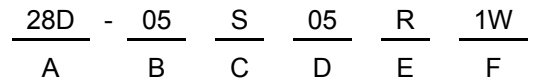

- A : Series
- B : Input Voltage
- C : Single(S);Dual(D)
- D : Output Voltage
- E : Regulated(R)
- F : Output Power

Recommended Test Circuit

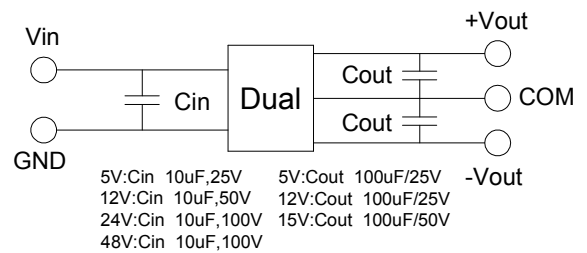
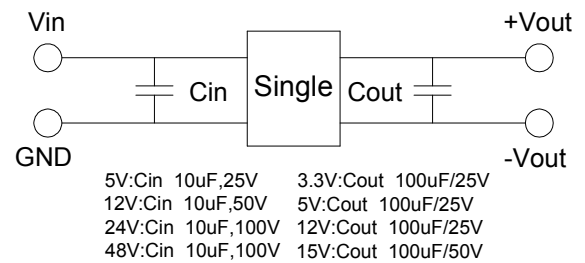

PIN Assignment

Pin	1	7	8	9	10	16
Single	-Vin	NC	NC	+Vout	-Vout	+Vin
Dual	-Vin	NC	Com	+Vout	-Vout	+Vin