



DESCRIPTION: Wide Input Non-Isolated, Regulated Single Output

The TP78xx-0.5 series have high efficiency, short circuit protection, Thermal shutdown, no heat sink required, Industry standard pinout .ideal for redialing 78xx linear regulates and are pin compatible.

FEATURES

ROHS compliant	Wide input non-isolated, regulated single output	Efficiency up to 96%
Short circuit protection, thermal shutdown	Temperature range: -40°C ~ +85°C	Low ripple and noise
SIP package	No heat sink required	Industry standard pinout

SELECTION GUIDE

Part Number	Input Voltage (VDC)		Output		Efficiency (%)	
	Nominal	Range	Voltage (VDC)	Current (mA)	Vin (Min)	Vin(Max)
TP781.5-0.5	12	4.75~26	1.5	500	76	66
TP781.8-0.5	12	4.75~28	1.8	500	79	67
TP782.5-0.5	12	4.75~28	2.5	500	85	73
TP783.3-0.5	24	4.75~28	3.3	500	90	80
TP785.0-0.5	24	6.5~30	5.0	500	93	84
TP786.5-0.5	24	8~32	6.5	500	94	87
TP789.0-0.5	24	11~32	9.0	500	95	91
TP7812-0.5	24	15~32	12	500	95	92
TP7815-0.5	24	18~32	15	500	96	93

OUTPUT CHARACTERISTICS

Parameter	Conditions	Min	Typ.	Max.	Units
Output voltage accuracy	100% full load		±2	±3	
Line regulation	Vin= min. to max. (at full load)	Vout:1.5V-2.5V	±0.5	±1.0	%
		Vout:3.3V-15V	±0.2	±0.4	
Load regulation	10% to 100% load	Vout:1.5V-2.5V	±0.4	±0.75	
		Vout:3.3V-15V	±0.4	±0.6	
Ripple & Noise	20MHz Bandwidth(refer to figure 3)		25	35	mvp-p
Short circuit input power			0.5	1.8	W
Short circuit protection		Continuous, automatic recovery			
Thermal shutdown	Internal IC junction		150		°C
Output current limit	Vin= min. to max. at full load)	Vout:1.5V-3.3V		3000	mA
		Vout:5V-15V		2000	
Switching frequency	At full load, input voltage range	280	330	450	KHz
Quiescent current			5	8	mA
Temperature coefficient	-40°C~+85°C			±0.02	%/°C
Max capacitance load				1000	µF

All specifications typical at TA=25°C, nominal input voltage and rated output current unless otherwise specified.

COMMON SPECIFICATIONS

Parameter	Conditions	Min.	Typ.	Max.	Units
Storage humidity range				95	
Operating temp. range	Power derating (above 71 °C)	-40		85	
Storage temp. range		-55		125	°C
Storage temp. Range Temp rise at full load				100	
Lead temperature	1.5mm from case for 10 seconds			300	
Cooling				Free air convection	
Case material				Plastic (UL94-V0)	
MTBF	25°C (MIL-HDBK-217F)	2000			k hours
Weight			2.0		g

TEMPERATURE DERATING GRAPHS

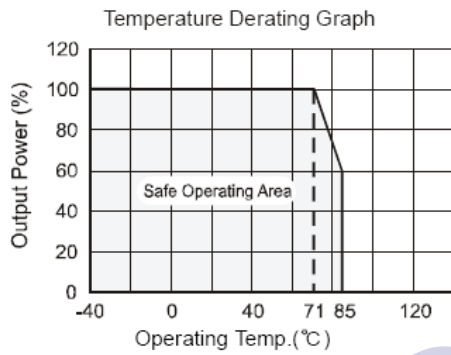

EXTERNAL CAPACITOR TABLE

Part Number	C1(Ceramic Capacitor)	C2(Ceramic Capacitor)
TP781.5-0.5	10μF/50V	22μF/6.3V
TP781.8-0.5	10μF/50V	22μF/6.3V
TP782.5-0.5	10μF/50V	22μF/6.3V
TP783.3-0.5	10μF/50V	22μF/6.3V
TP785.0-0.5	10μF/50V	22μF/10V
TP786.5-0.5	10μF/50V	10μF/10V
TP789.0-0.5	10μF/50V	10μF/16V
TP7812-0.5	10μF/50V	10μF/25V
TP7815-0.5	10μF/50V	10μF/25V

STANDARD APPLICATION CIRCUIT

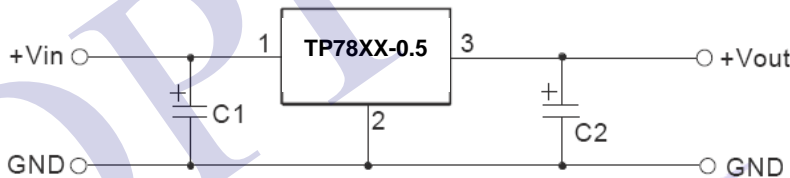

- Note:
1. C1 and C2 are required and should be fitted close to the converter pins.
 2. The capacitance of C1,C2 sees external capacitor table, it can be increased properly if required, and tantalum or low ESR electrolytic capacitors may also suffice.
 3. No parallel connection or plug and play.

TEST CONFIGURATIONS (TA=25°C)

1. Efficiency and Output Voltage Ripple Test

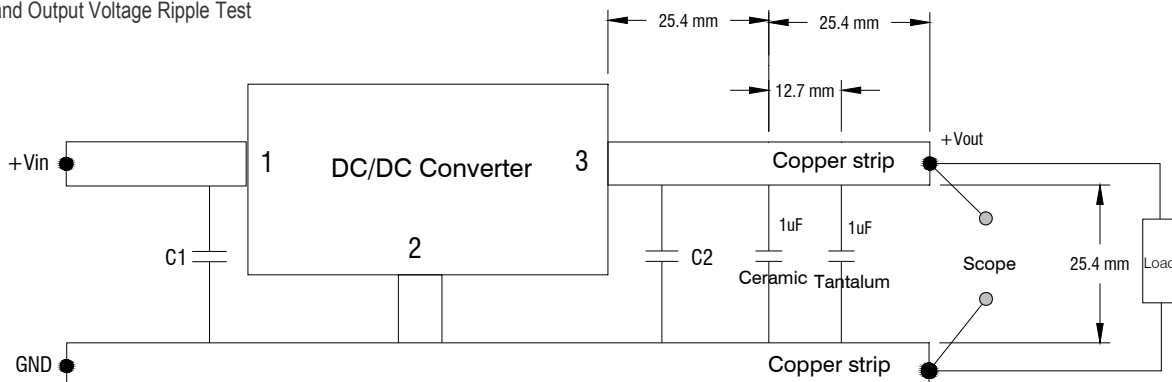

TEST CONFIGURATIONS (TA=25°C)

2.Start-up and Load Transient Response Test

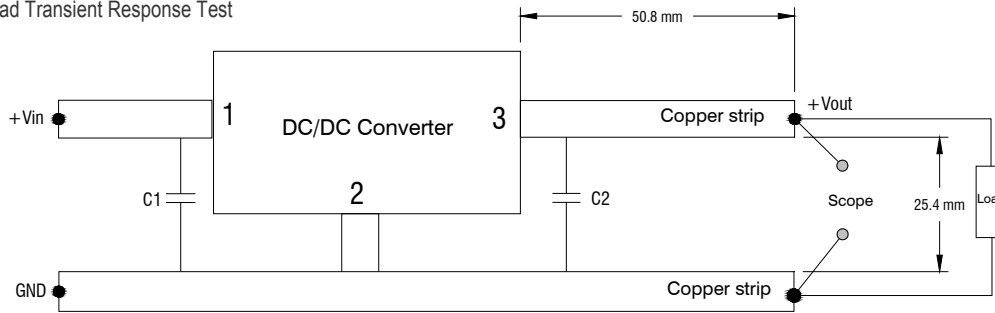

OUTPUT RIPPLE REDUCTION

To reduce output ripple, it is recommended to add a LC filter in output port. L: Recommended parameter $10 \mu H \sim 47 \mu H$.

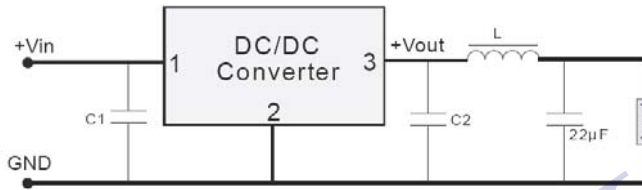

MECHANICAL DIMENSIONS

SIP Package

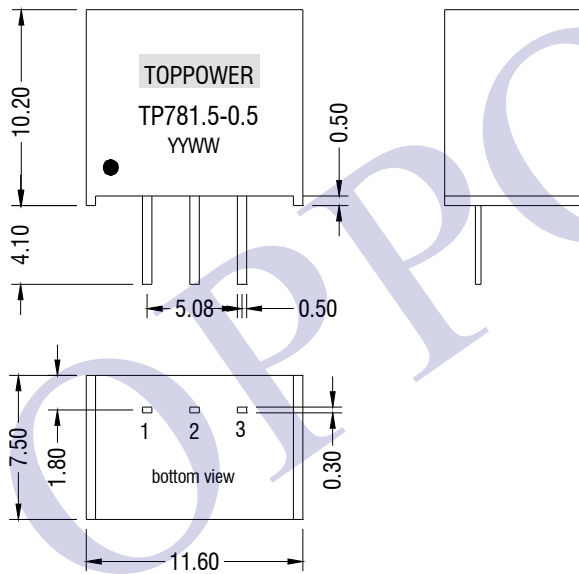

All dimensions in mm ± 0.25 . All pins on a 2.54mm pitch.

PIN CONNECTIONS

Pin	Function
1	+Vin
2	GND
3	+Vout

RECOMMENDED FOOTPRINT DETAILS

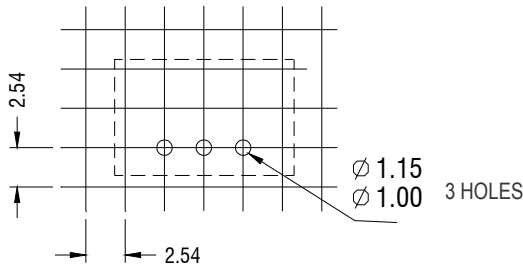

Unless otherwise stated all dimensions in mm ± 0.5 mm.

TUBE OUTLINE DIMENSIONS

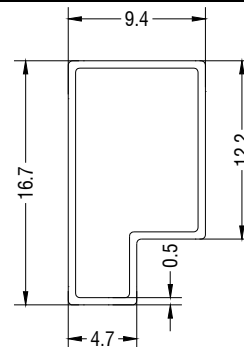

Unless otherwise stated all dimensions in mm ± 0.5 mm.

L=520mm ± 2 mm Packaging quantity:43PCS

L=220mm ± 2 mm Packaging quantity:17PCS