

THIS DRAWING IS UNPUBLISHED. RELEASED FOR PUBLICATION 20
 © COPYRIGHT 20 BY - ALL RIGHTS RESERVED.

REVISIONS					
LOC	DIST	DESCRIPTION	DATE	DWN	APVD
-	-	G ECR-13-018192	27NOV2013	TB	DM
-	-	H ECR-15-001933	16FEB2015	TB	DM

2106391-1 SHOWN

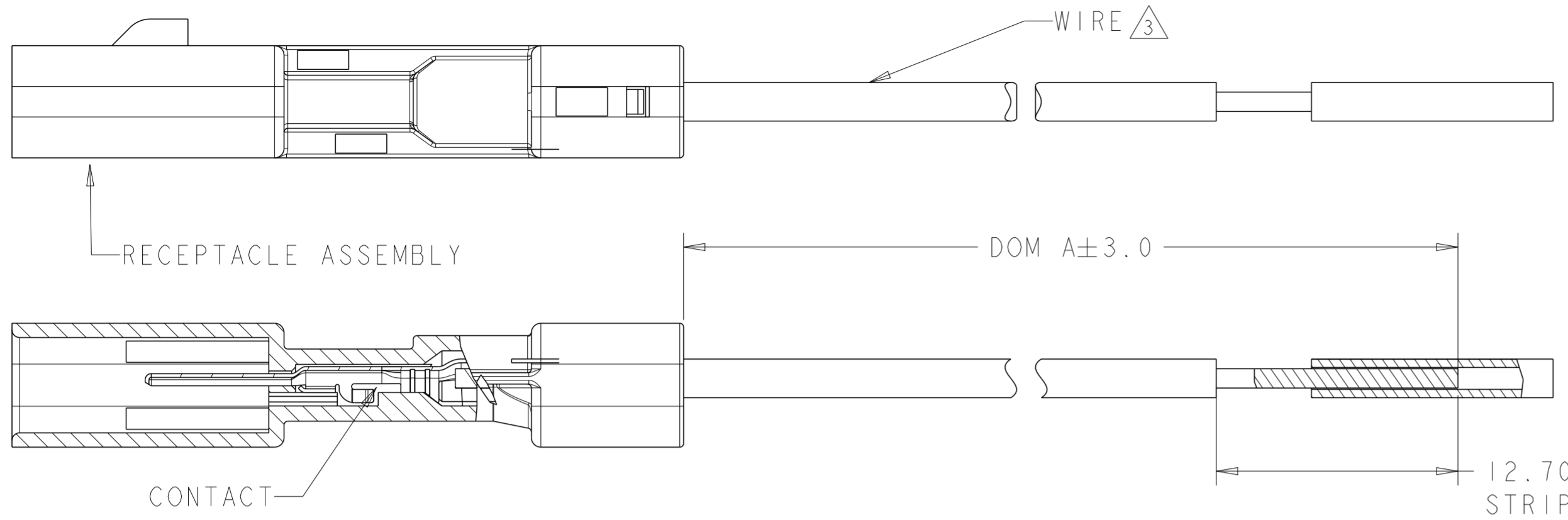

2106391-2, 2106391-5, 2106391-8, 1-2106391-1, 1-2106391-4, 1-2106391-7, 2-2106391-0, 2-2106391-3, 2-2106391-6, 2-2106391-7 and 2-2106391-8 SHOWN

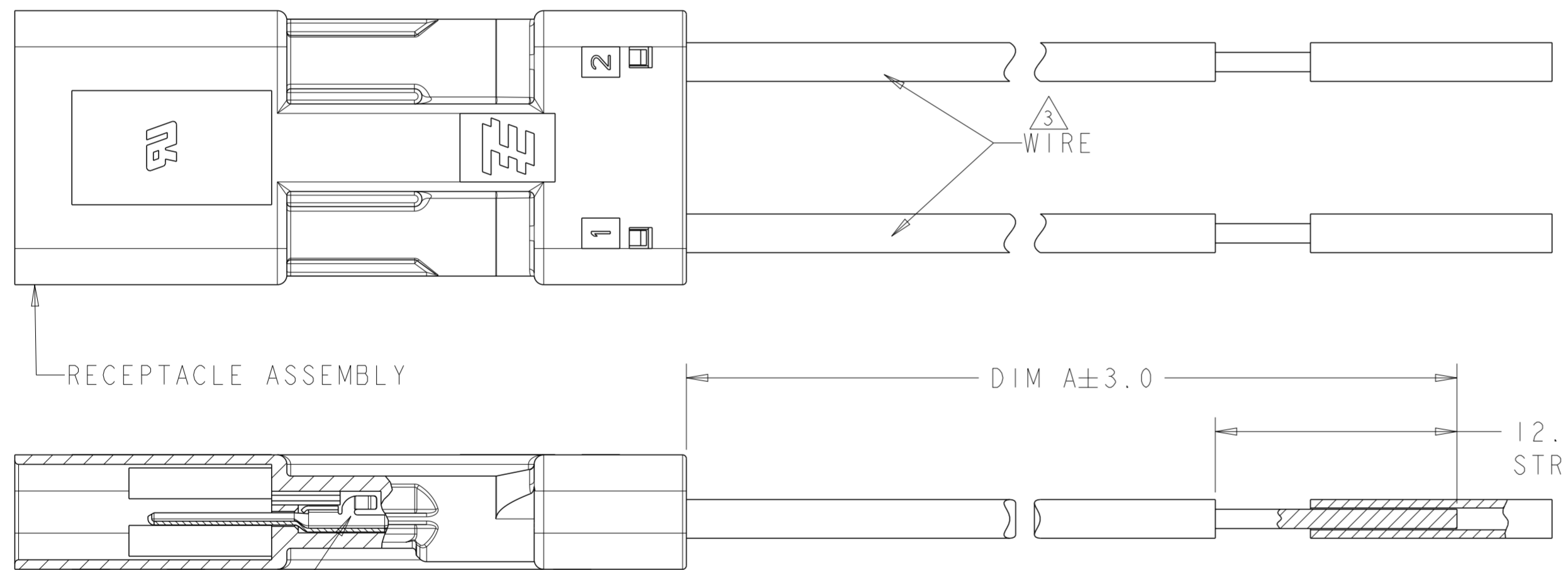

DIM A	WIRE SIZE	POSN	PART NO.
2000.0	20 AWG	2	2-2106391-8
5000.0	18 AWG	2	2-2106391-7
381.0	18 AWG	2	2-2106391-6
304.8	24 AWG	4	2-2106391-5
304.8	24 AWG	3	2-2106391-4
304.8	24 AWG	2	2-2106391-3
101.6	24 AWG	4	2-2106391-2
101.6	24 AWG	3	2-2106391-1
101.6	24 AWG	2	2-2106391-0
304.8	22 AWG	4	1-2106391-9
304.8	22 AWG	3	1-2106391-8
304.8	22 AWG	2	1-2106391-7
101.6	22 AWG	4	1-2106391-6
101.6	22 AWG	3	1-2106391-5
101.6	22 AWG	2	1-2106391-4
304.8	20 AWG	4	1-2106391-3
304.8	20 AWG	3	1-2106391-2
304.8	20 AWG	2	1-2106391-1
101.6	20 AWG	4	1-2106391-0
101.6	20 AWG	3	2106391-9
101.6	20 AWG	2	2106391-8
304.8	18 AWG	4	2106391-7
304.8	18 AWG	3	2106391-6
304.8	18 AWG	2	2106391-5
101.6	18 AWG	4	2106391-4
101.6	18 AWG	3	2106391-3
101.6	18 AWG	2	2106391-2
101.6	18 AWG	1	2106391-1

POS	-1	-2	-3	-4	-5	-6	-7	-8	-9	-10	-11	-12	-13	-14	-15	-16	-17	-18	-19	-20	-21	-22	-23	-24	-25	-26	-27	-28
4	-	-	-	BLUE	-	-	BLUE	-	-	BLUE	-	-	BLUE	-	-	BLUE	-	-	BLUE	-	-	BLUE	-	-	BLUE	-	-	-
3	-	-	WHITE	WHITE	-	WHITE	WHITE	-	WHITE	WHITE	-	WHITE	WHITE	-	WHITE	WHITE	-	WHITE	WHITE	-	WHITE	WHITE	-	WHITE	WHITE	-	-	-
2	-	RED	RED	RED	RED	RED	RED	RED	RED	RED	RED	RED	RED	RED	RED	RED	RED	RED	RED	RED	RED	RED	RED	RED	RED	RED	RED	RED
1	BLACK	BLACK	BLACK	BLACK	BLACK	BLACK	BLACK	BLACK	BLACK	BLACK	BLACK	BLACK	BLACK	BLACK	BLACK	BLACK	BLACK	BLACK	BLACK	BLACK	BLACK	BLACK	BLACK	BLACK	BLACK	BLACK	BLACK	BLACK

△ MATERIALS AND FINISH:
 -CONTACTS: COPPER ALLOY
 FINISH: TIN IN CONTACT AREA OVER NICKEL UNDERPLATE
 -WIRE: 18 AWG, STRANDED, UL 1007 STYLE

2. MUST COMPLY WITH DIRECTIVE 2002/95/EC (ROHS)

△ REFERENCE CHART FOR SPECIFIC WIRE COLOR/POSITION

THIS DRAWING IS A CONTROLLED DOCUMENT.

DIMENSIONS: mm

TOLERANCES UNLESS OTHERWISE SPECIFIED:

0 PLC	±
1 PLC	±0.2
2 PLC	±
3 PLC	±
4 PLC	±
ANGLES	±
FINISH	±

MATERIAL: -

DWN: R BROWN 20APR2009
 CHK: M MOSTOLLER 20APR2009
 APVD: -

PRODUCT SPEC: -
 APPLICATION SPEC: -
 WEIGHT: -

Customer Drawing

STE TE Connectivity

NAME: CABLE ASSEMBLY, RECEPTACLE, SLIMSEAL SSL CONNECTOR

SIZE: A2 CAGE CODE: 00779 DRAWING NO: 2106391 RESTRICTED TO: -

SCALE: 4:1 SHEET 1 OF 3 REV: H

THIS DRAWING IS UNPUBLISHED. RELEASED FOR PUBLICATION 20
 © COPYRIGHT 20 BY - ALL RIGHTS RESERVED.

LOC		DIST		REVISIONS			
P	LTR	DESCRIPTION	DATE	DWN	APVD		
-	-	SEE SHEET 1	-	-	-		

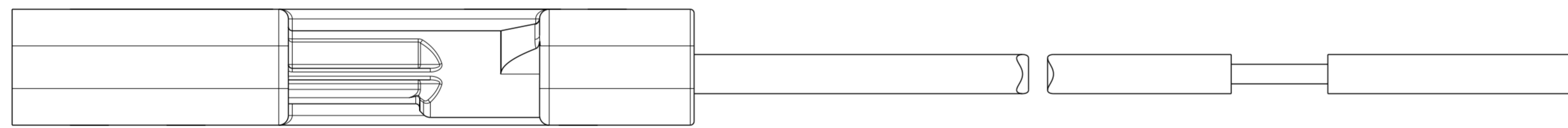
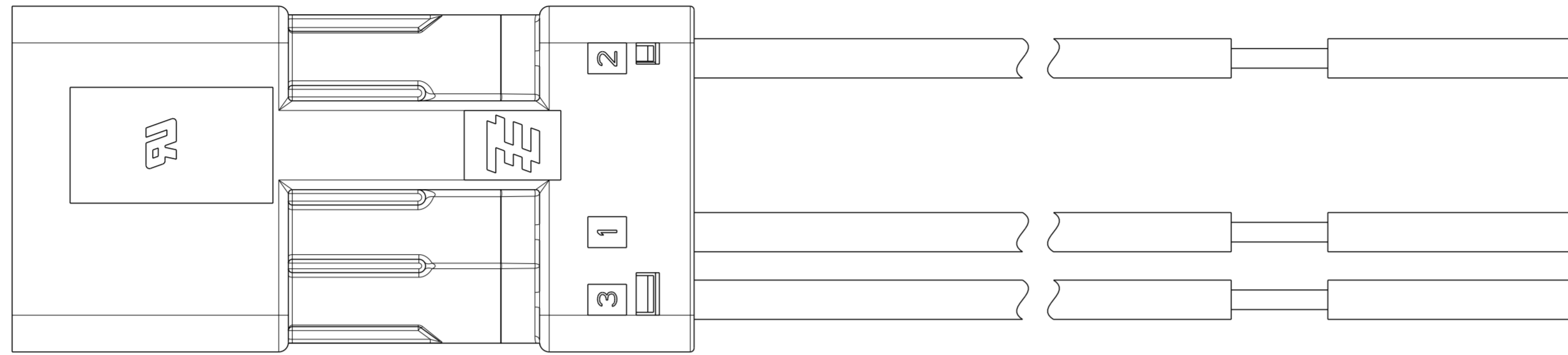

2106391-3, 2106391-6, 2106391-9, 1-2106391-2, 1-2106391-5, 1-2106391-8, 2-2106391-1 and 2-2106391-4 SHOWN

2106391-3 SHOWN
 (SAME AS 2106391-2 EXCEPT 3 POSITION) 

THIS DRAWING IS A CONTROLLED DOCUMENT.		DWN R BROWN 20APR2009	 TE Connectivity	
DIMENSIONS: mm		CHK M MOSTOLLER 20APR2009		
TOLERANCES UNLESS OTHERWISE SPECIFIED:		APVD -	NAME CABLE ASSEMBLY, RECEPTACLE, SLIMSEAL SSL CONNECTOR	
0 PLC ± 1 PLC ±0.2 2 PLC ± 3 PLC ± 4 PLC ± ANGLES ± FINISH		PRODUCT SPEC -	RESTRICTED TO -	
MATERIAL -		APPLICATION SPEC -	SIZE A200779	DRAWING NO C-2106391
-		WEIGHT -	SCALE 4:1	SHEET 2 OF 3 REV H
-		Customer Drawing		

THIS DRAWING IS UNPUBLISHED. RELEASED FOR PUBLICATION 20
 © COPYRIGHT 20 BY - ALL RIGHTS RESERVED.

LOC		DIST		REVISIONS			
P	LTR	DESCRIPTION	DATE	DWN	APVD		
-	-	SEE SHEET 1	-	-	-		

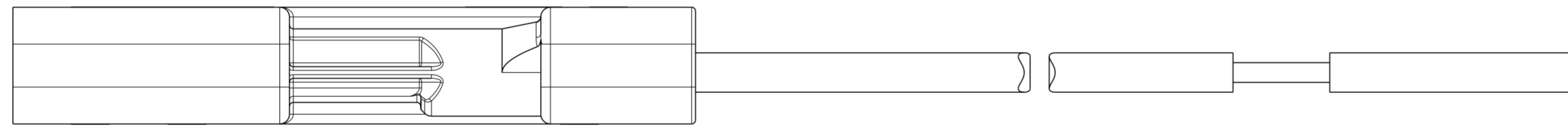
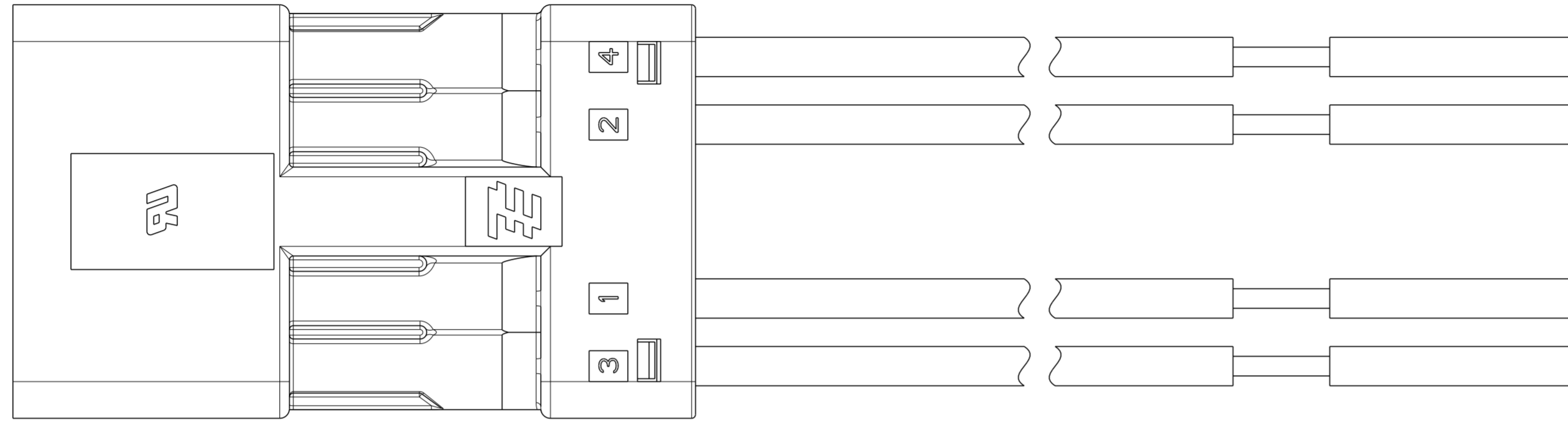

2106391-4, 2106391-7, 1-2106391-0, 1-2106391-3, 1-2106391-6, 1-2106391-9, 2-2106391-2 and 2-2106391-5 SHOWN

2106391-4 SHOWN
 (SAME AS 2106391-2 EXCEPT 4 POSITION)

THIS DRAWING IS A CONTROLLED DOCUMENT.		DWN R BROWN 20APR2009	TE Connectivity	
DIMENSIONS: mm		CHK M MOSTOLLER 20APR2009		
TOLERANCES UNLESS OTHERWISE SPECIFIED:		APVD -	NAME CABLE ASSEMBLY, RECEPTACLE, SLIMSEAL SSL CONNECTOR	
0 PLC ± 1 PLC ±0.2 2 PLC ± 3 PLC ± 4 PLC ± ANGLES ± FINISH		PRODUCT SPEC -	SIZE A200779	
MATERIAL -		APPLICATION SPEC -	DRAWING NO C-2106391	
		WEIGHT -	RESTRICTED TO -	
		Customer Drawing	SCALE 4:1	SHEET 3 OF 3
			REV H	