

RM600DY-66S

HIGH POWER SWITCHING USE
INSULATED TYPE

High Voltage Diode Module

RM600DY-66S



- IF 600A
- VRRM 3300V
- Insulated Type
- 2-element in a Pack
- Copper Baseplate

APPLICATION

Traction drives, High Reliability Converters / Inverters, DC choppers

OUTLINE DRAWING & CIRCUIT DIAGRAM

Dimensions in mm

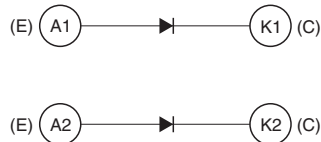
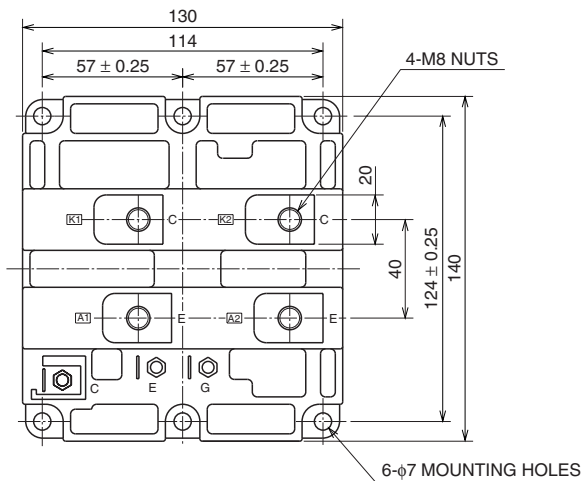

CIRCUIT DIAGRAM

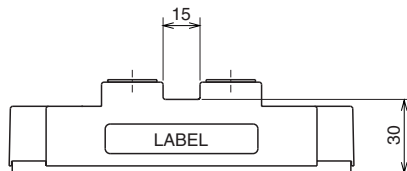
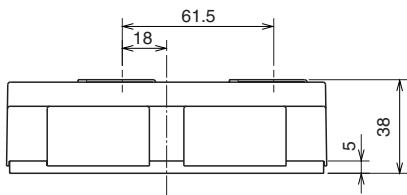

High Voltage Diode Module

RM600DY-66S

**HIGH POWER SWITCHING USE
INSULATED TYPE**

High Voltage Diode Module

MAXIMUM RATINGS

Symbol	Item	Conditions	Ratings	Unit
VRRM	Repetitive peak reverse voltage	T _j = 25 °C	3300	V
V _{RRM}	Non-repetitive peak reverse voltage	T _j = 25 °C	3300	V
V _{R(DC)}	Reverse DC voltage	T _j = 25 °C	2200	V
I _F	DC forward current	T _c = 25 °C	600	A
I _{FSM}	Surge forward current	T _j = 25 °C start, t _w = 8.3 ms Half sign wave	4800	A
i ² t	Current-squared, time integration	T _j = 25 °C start, t _w = 8.3 ms Half sign wave	96	kA ² s
V _{iso}	Isolation voltage	Charged part to the baseplate RMS sinusoidal, 60Hz 1min.	6000	V
T _j	Junction temperature	—	-40 ~ +150	°C
T _{op}	Operating temperature	—	-40 ~ +125	°C
T _{stg}	Storage temperature	—	-40 ~ +125	°C

ELECTRICAL CHARACTERISTICS

Symbol	Item	Conditions	Limits			Unit
			Min	Typ	Max	
I _{RRM}	Repetitive reverse current	V _{RM} = V _{RRM}	T _j = 25 °C	—	4.0	mA
			T _j = 125 °C	—	15	
V _{FM}	Forward voltage (Note 1)	I _F = 600 A	T _j = 25 °C	—	4.55	V
			T _j = 125 °C	—	3.75	
t _{rr}	Reverse recovery time	V _R = 1650 V, I _F = 600 A di/dt = -1200 A/μs L _s =200nH, T _j = 125 °C	—	0.75	—	μs
I _{rr}	Reverse recovery current		—	450	—	A
Q _{rr}	Reverse recovery charge		—	300	—	μC
E _{rec}	Reverse recovery energy (Note 2)		—	0.23	—	J/P

Note 1. It doesn't include the voltage drop by internal lead resistance.
2. E_{rec} is the integral of 0.1V_Rx 0.1I_{rr}x dt.

RM600DY-66S

**HIGH POWER SWITCHING USE
INSULATED TYPE**

High Voltage Diode Module

THERMAL CHARACTERISTICS

Symbol	Item	Conditions	Limits			Unit
			Min	Typ	Max	
Rth(j-c)	Thermal resistance	Junction to case (per 1/2 module)	—	—	48.0	K/kW
Rth(c-f)	Contact thermal resistance	Case to Fin, $\lambda_{grease} = 1W/m\cdot K$ $D_{(c-f)}=100\mu m$, (per 1/2 module)	—	24.0	—	K/kW

MECHANICAL CHARACTERISTICS

Symbol	Item	Conditions	Limits			Unit
			Min	Typ	Max	
Mt	Mounting torque	M8: Main terminals screw	6.67	—	8.24	N·m
Ms		M6: Mounting screw	2.84	—	3.43	N·m
m	Mass	—	—	1.5	—	kg

PERFORMANCE CURVES

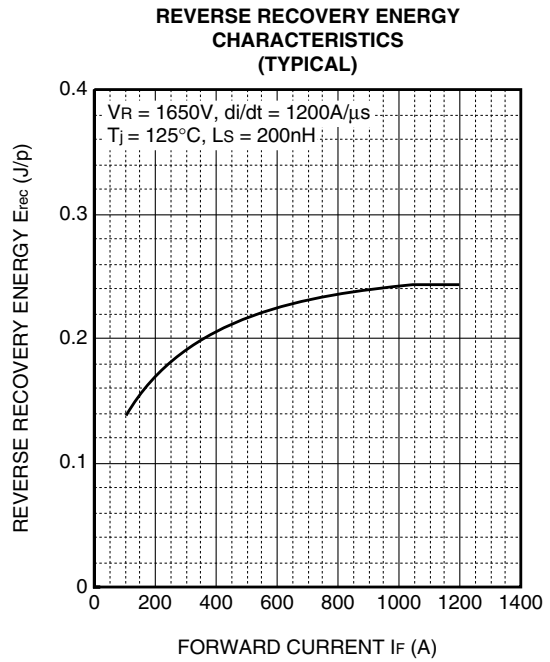
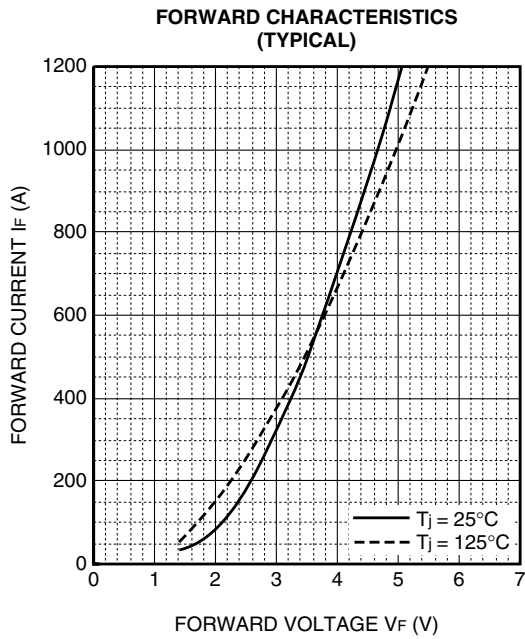

RM600DY-66S

**HIGH POWER SWITCHING USE
INSULATED TYPE**

High Voltage Diode Module

REVERSE RECOVERY CHARACTERISTICS (TYPICAL)

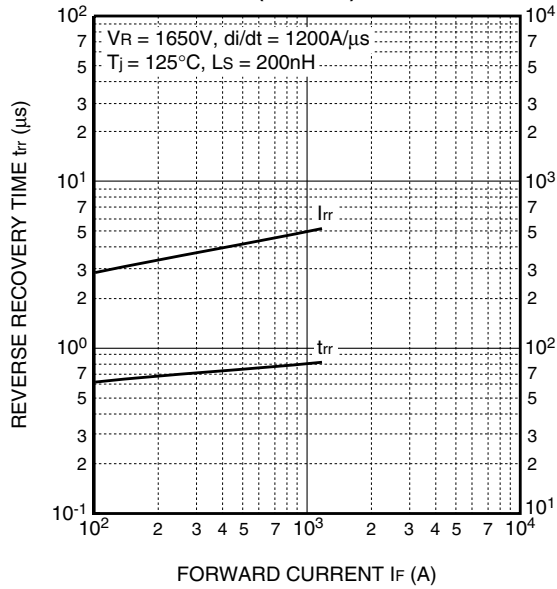

REVERSE RECOVERY SAFE OPERATING AREA (RRSOA)

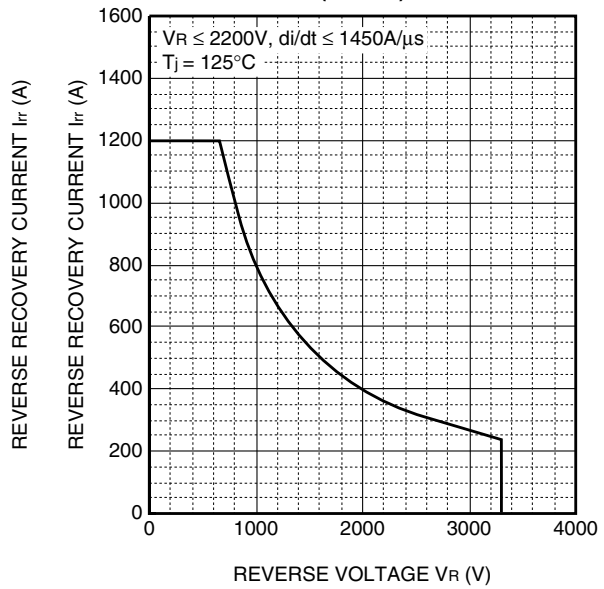

TRANSIENT THERMAL IMPEDANCE CHARACTERISTICS

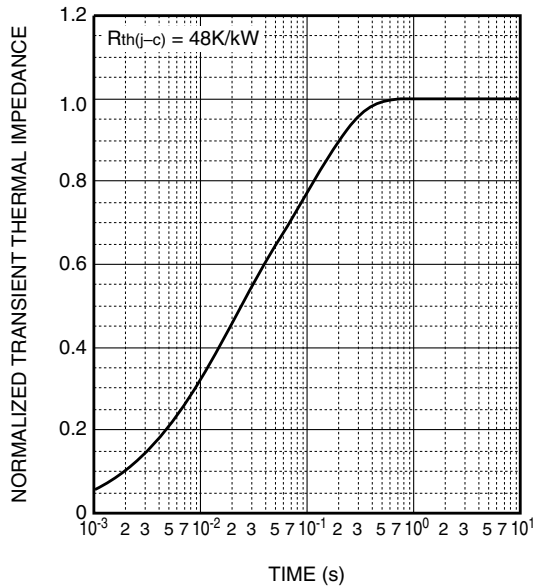

High Voltage Diode Module