

GaAs SPDT IC 7 W T/R Switch DC–6 GHz



AS230-348

Features

- Low DC Power Consumption
- Low Insertion Loss
- High Linearity (63 dBm IP3)
- T/R Switch
- Small Low Cost Plastic Package

Description

The AS230-348 is an IC FET SPDT switch in a low cost plastic package. It features extremely high linearity, low insertion loss, with very low DC power consumption. Some standard implementations include antenna changeover, T/R and diversity switching over 2 W. This switch can be used in many analog and digital wireless communication systems.

-348 (QFN 3 x 3)

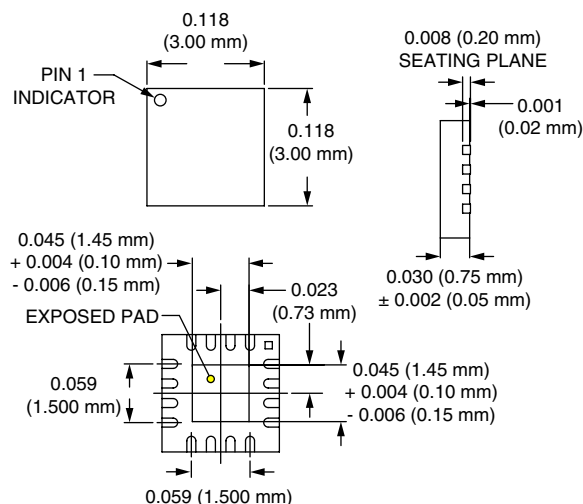

Electrical Specifications at 25°C

Parameter ¹	Frequency ⁵	Min.	Typ.	Max.	Unit
Insertion Loss ²	DC–1.0 GHz		0.8	1.0	dB
	DC–2.0 GHz		0.9	1.1	dB
	DC–4.0 GHz		1.0	1.2	dB
	DC–6.0 GHz		1.2	1.4	dB
Isolation	DC–1.0 GHz	28	30		dB
	DC–2.0 GHz	23	25		dB
	DC–4.0 GHz	14	16		dB
	DC–6.0 GHz	13	15		dB
Return Loss ³	DC–1.0 GHz		22		dB
	DC–2.0 GHz		22		dB
	DC–4.0 GHz		15		dB
	DC–6.0 GHz		20		dB

Operating Characteristics at 25°C

Parameter	Condition	Frequency	Min.	Typ.	Max.	Unit
Switching Characteristics	Rise, Fall (10/90% or 90/10% RF)			6		ns
	On, Off (50% CTL to 90/10% RF)			12		ns
	Video Feedthru ⁴			30		mV
Input Power for 1 dB Compression	@ -5 V	0.9 GHz		35		dBm
	@ -10 V	0.9 GHz		40		dBm
Intermodulation Intercept Point (IP3)	For Two-tone Input Power 13 dBm, V _{High} = -10 V	0.9 GHz		63		dBm
Control Voltages	V _{Low} = -12.0 V ≤ V _{Low} ≤ 0 V, 500 μA Max. V _{High} = 0 V ≤ V _{High} ≤ +12.0 V, 500 μA Max. Differential = + 5.0 V ≤ (V _{High} - V _{Low}) < +12.0 V					

1. All measurements made in a 50 Ω system, unless otherwise specified.

2. Insertion loss changes by 0.003 dB/°C.

3. Insertion loss state.

4. Video feedthru measured with 1 ns risetime pulse and 500 MHz bandwidth.

5. DC = 300 kHz.

Typical Performance Data

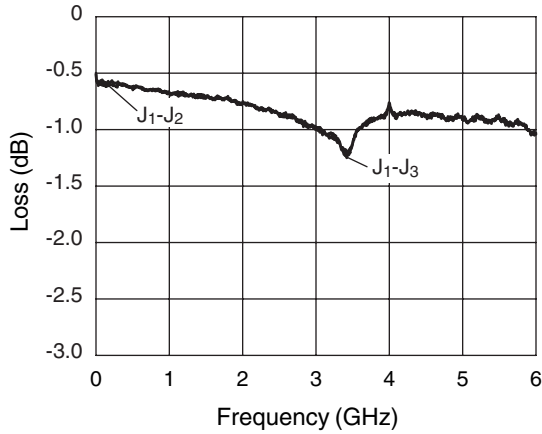

Insertion Loss

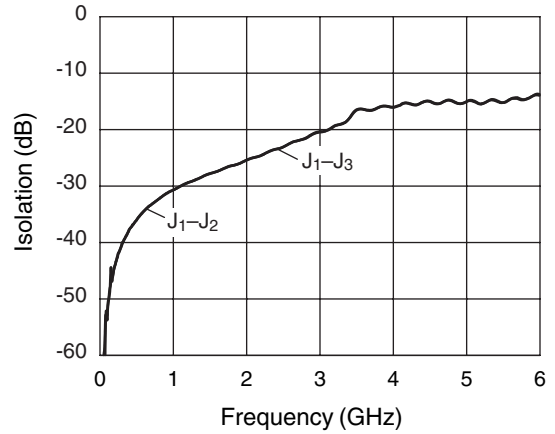

Isolation

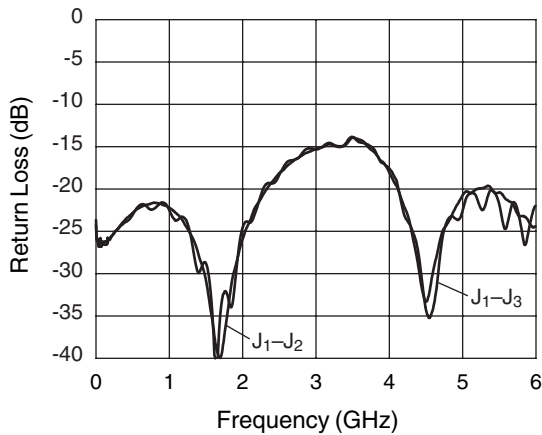

Return Loss

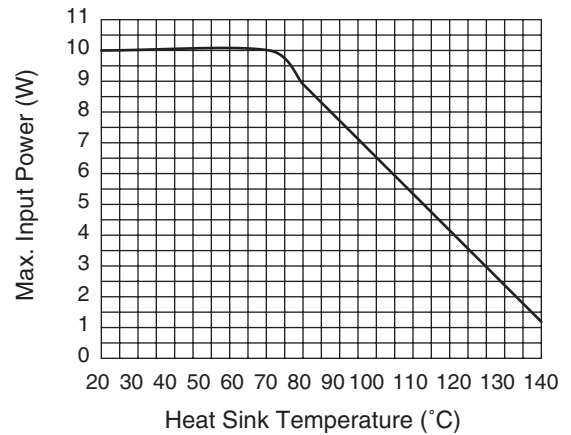

Temperature Derating Curve (0, 10 V)

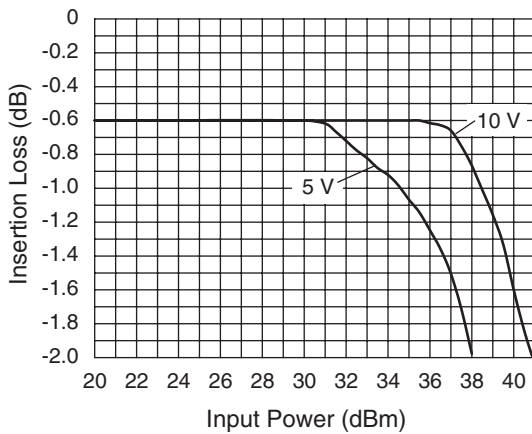

Compression at 900 MHz 25°C

Absolute Maximum Ratings

Characteristic	Value
RF Input Power (RF In)	8 W Max. > 900 MHz 0/-10 V Control
Control Voltage (V _C)	+0.2 V, -12 V
Operating Temperature (T _{OP})	-40°C to +85°C
Storage Temperature (T _{ST})	-65°C to +150°C
Thermal Resistance (θ _{JC})	45°C/W

Truth Table

V ₁	V ₂	J ₁ –J ₂	J ₁ –J ₃
V _{High}	V _{Low}	Insertion Loss	Isolation
V _{Low}	V _{High}	Isolation	Insertion Loss

V_{Low} = 0 to -12.0 V.
 V_{High} = 0 to +12.0 V.
 Differential = +5.0 V ≤ (V_{High} – V_{Low}) < +12.0 V.

Pin Out

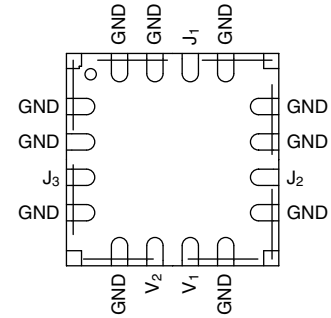

Exposed paddle should be grounded.
 DC blocking capacitors (C_{BL}) are required on RF lines for positive voltage operation.