



WLL170-2P360

WLL170-2

FIBER-OPTIC SENSORS AND FIBERS

SICK
Sensor Intelligence.



Illustration may differ



Ordering information

| Type | Part no. |
|--------------|----------|
| WLL170-2P360 | 6029529 |

Other models and accessories → www.sick.com/WLL170-2

Detailed technical data

Features

| | |
|--|---|
| Sensor/detection principle | Fiber-optic photoelectric sensor |
| Dimensions (W x H x D) | 10.5 mm x 35.5 mm x 83.7 mm |
| Housing design (light emission) | Rectangular |
| Sensing range max. | 0 mm ... 1,600 mm, Through-beam system ¹⁾ |
| Sensing range | 0 mm ... 65 mm, Proximity system ^{2) 3)} 0 mm ... 350 mm, Through-beam system ⁴⁾ |
| Focus | ⁵⁾ |
| Type of light | Visible red light |
| Light source | LED ⁶⁾ |
| Angle of dispersion | Approx. 65° ⁵⁾ |
| Wave length | 660 nm |
| Adjustment | Potentiometer, 10 turns |
| Time type | Off delay |
| Delay time | Selectable by sliding switch, 40 ms |
| Indication | LED |

¹⁾ LL3-TB02 and tip adapter LL3-TA01.

²⁾ Objects to be sensed with 90% reflectivity (based on DIN 5033 white standard). Sensing range depends on fiber-optic cable.

³⁾ LL3-DB01.

⁴⁾ LL3-TB01.

⁵⁾ See LL3 fiber-optic data.

⁶⁾ Average service life: 100,000 h at T_U = +25 °C.

Mechanics/electronics

| | |
|--|--|
| Supply voltage | 10 V DC ... 30 V DC ¹⁾ |
| Ripple | 10 % ²⁾ |
| Power consumption | ≤ 30 mA ³⁾ |
| Output type | PNP |
| Number of switching outputs | 1 |
| Switching mode | Light/dark switching |
| Switching mode selector | Selectable via light/dark selector |
| Output current I_{max.} | ≤ 100 mA |
| Response time | ≤ 50 μs ⁴⁾ |
| Switching frequency | 10,000 Hz ⁵⁾ |
| Input | - |
| Connection type | Connector M8, 3-pin |
| Circuit protection | A ⁶⁾ B ⁷⁾ C ⁸⁾ D ⁹⁾ |
| Protection class | III |
| Weight | 70 g |
| Housing material | Plastic, ABS/PC |
| Enclosure rating | IP66 ¹⁰⁾ |
| Items supplied | BEF-WLL170 mounting bracket |
| Ambient operating temperature | -25 °C ... +55 °C |
| Ambient storage temperature | -40 °C ... +70 °C |
| UL File No. | NRKH.E300503 & NRKH7.E300503 |

¹⁾ Limit values.

²⁾ May not exceed or fall below U_v tolerances.

³⁾ Without load.

⁴⁾ Signal transit time with resistive load.

⁵⁾ With light/dark ratio 1:1.

⁶⁾ A = V_S connections reverse-polarity protected.

⁷⁾ B = inputs and output reverse-polarity protected.

⁸⁾ C = interference suppression.

⁹⁾ D = outputs overcurrent and short-circuit protected.

¹⁰⁾ With correctly attached fibre-optic cable LL3 and closed protection hood.

Classifications

| | |
|---------------------|----------|
| ECl@ss 5.0 | 27270905 |
| ECl@ss 5.1.4 | 27270905 |
| ECl@ss 6.0 | 27270905 |
| ECl@ss 6.2 | 27270905 |
| ECl@ss 7.0 | 27270905 |
| ECl@ss 8.0 | 27270905 |
| ECl@ss 8.1 | 27270905 |

| | |
|-----------------------|----------|
| ECl@ss 9.0 | 27270905 |
| ETIM 5.0 | EC002651 |
| ETIM 6.0 | EC002651 |
| UNSPSC 16.0901 | 39121528 |

Adjustments possible

WLL170-2

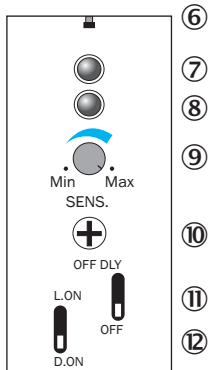

- ⑥ Indicating pin correctly inserted LL3 fiber
- ⑦ LED indicator orange, lights up when switching output is active
- ⑧ LED signal strength indicator green, lights up, when light received < 0.9 or > 1.1 (switching threshold = 1)
- ⑨ Sensitivity scale 270°
- ⑩ Sensitivity control (10 revolutions)
- ⑪ OFF delay selector switch: "OFF DLY" (on)/"OFF" (off), 40 ms fixed
- ⑫ Selector switch: "L.ON" (light switching) /"D.ON" (dark switching)

Connection diagram

Cd-045

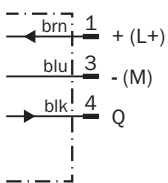

Dimensional drawing (Dimensions in mm (inch))



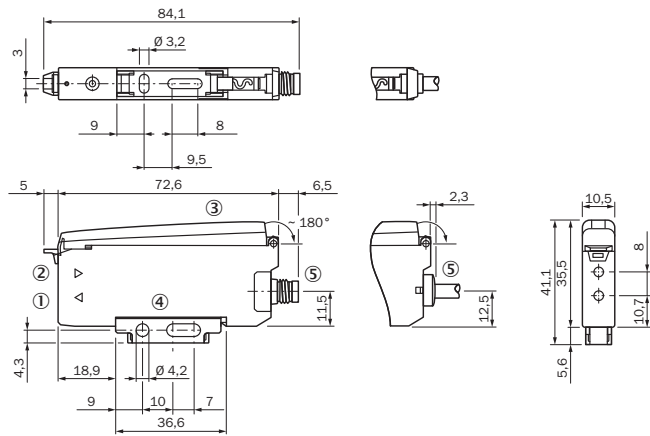

WLL170-2



- ① Sender LED, installation of LL3 fibre-optic cable (sender fibre)
- ② Receiver, installation of LL3 fibre optic cable (receiver fibre)
- ③ Protective hood, can be raised at both ends
- ④ Mounting bracket, included with delivery
- ⑤ Connection

Recommended accessories

Other models and accessories → www.sick.com/WLL170-2

| | Brief description | Type | Part no. |
|---|---|---------------|-----------------|
| Mounting brackets and plates | | | |
|  | Mounting bracket, steel, zinc coated, without mounting hardware | BEF-WLL170 | 5306574 |
| Other mounting accessories | | | |
|  | Rail end piece for block mounting, Stainless steel, mounting hardware included | BEF-EB01-W190 | 5313011 |
|  | Cutter for fibers, supplied with LL3 | FC | 5304141 |
| Plug connectors and cables | | | |
|  | Head A: female connector, M8, 3-pin, straight Head B: cable Cable: PVC, unshielded, 2 m | DOL-0803-G02M | 6010785 |
| | Head A: female connector, M8, 3-pin, straight Head B: cable Cable: PVC, unshielded, 5 m | DOL-0803-G05M | 6022009 |
|  | Head A: female connector, M8, 3-pin, angled Head B: cable Cable: PVC, unshielded, 2 m | DOL-0803-W02M | 6008489 |
| | Head A: female connector, M8, 3-pin, angled Head B: cable Cable: PVC, unshielded, 5 m | DOL-0803-W05M | 6022010 |

| | Brief description | Type | Part no. |
|---|---|------------|----------|
|  | Head A: female connector, M8, 3-pin, straight Head B: - Cable: unshielded | DOS-0803-G | 7902077 |
|  | Head A: female connector, M8, 3-pin, angled Head B: - Cable: unshielded | DOS-0803-W | 7902078 |
|  | Head A: female connector, M8, 4-pin, straight Head B: - Cable: unshielded | DOS-0804-G | 6009974 |
|  | Head A: female connector, M8, 4-pin, angled Head B: - Cable: unshielded | DOS-0804-W | 6009975 |
|  | Head A: male connector, M8, 3-pin, straight Head B: - Cable: unshielded | STE-0803-G | 6037322 |

SICK AT A GLANCE

SICK is one of the leading manufacturers of intelligent sensors and sensor solutions for industrial applications. A unique range of products and services creates the perfect basis for controlling processes securely and efficiently, protecting individuals from accidents and preventing damage to the environment.

We have extensive experience in a wide range of industries and understand their processes and requirements. With intelligent sensors, we can deliver exactly what our customers need. In application centers in Europe, Asia and North America, system solutions are tested and optimized in accordance with customer specifications. All this makes us a reliable supplier and development partner.

Comprehensive services complete our offering: SICK LifeTime Services provide support throughout the machine life cycle and ensure safety and productivity.

For us, that is “Sensor Intelligence.”

WORLDWIDE PRESENCE:

Contacts and other locations –www.sick.com