

PLEASE CHECK WWW.MOLEX.COM FOR LATEST PART INFORMATION

Part Number: **0923150836**
Status: **Active**
Overview: Picoflex Ribbon-Cable Connectors
Description: Picoflex PF-50 IDT-to-Picoflex PF-50 IDT Cable Assembly, 0.36m Length, Tin (Sn) Plating, 8 Circuits

Documents:

[3D Model](#) [Product Specification PS-99020-0011-001 \(PDF\)](#)
[Drawing \(PDF\)](#) [RoHS Certificate of Compliance \(PDF\)](#)

Application tooling part link

Application Tooling Part Link 62100-6000
 Application Tooling Part Link 62100-6010

General

Product Family Cable Assemblies
 Series [92315](#)
 Assembly Configuration Dual Ended Connectors
 Connector to Connector Picoflex IDT-to-IDT
 Overview [Picoflex Ribbon-Cable Connectors](#)
 Product Name Picoflex
 UPC 884982153868

Physical

Cable Length 0.36m
 Circuits (Loaded) 8
 Color - Resin Natural
 Gender Female-Female
 Lock to Mating Part None
 Material - Metal Phosphor Bronze
 Material - Plating Mating Tin
 Material - Plating Termination Tin
 Material - Resin Polyester
 Net Weight 5.920/g
 Number of Rows 2
 Packaging Type Bag
 Pitch - Mating Interface 1.27mm
 Plating min - Mating 2.032µm
 Plating min - Termination 2.032µm
 Single Ended No
 Termination Interface: Style IDT or Pierce
 Waterproof / Dustproof No
 Wire Insulation Diameter N/A
 Wire Size AWG 28
 Wire/Cable Type PVC, Ribbon Cable

Electrical

Current - Maximum per Contact 1.2A
 Shielded No
 Voltage - Maximum 250V

Material Info

Reference - Drawing Numbers

Product Specification PS-99020-0011-001
 Sales Drawing SD-92315-001-001

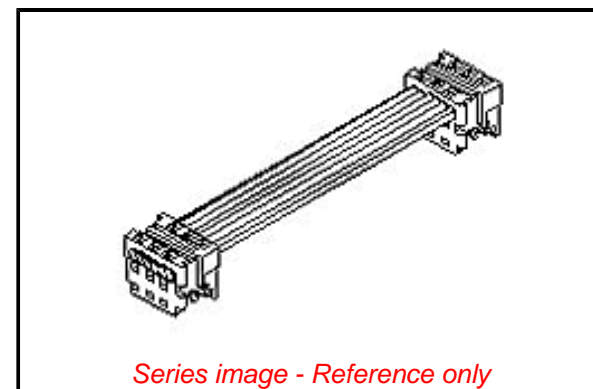

Series image - Reference only

EU ELV

Not Relevant

EU RoHS

Compliant

REACH SVHC

Not Contained Per -
 D(2020)9139-DC (19
 Jan 2021)

Halogen-Free

Status

Not Low-Halogen

For more information, please visit [Contact US](#)

China ROHS

ELV

RoHS Phthalates

China RoHS

Green Image

Not Relevant

Not Contained

Search Parts in this Series

[92315](#) Series

Mates With

Picoflex PF-50 Header [90325](#) , [90800](#) ,
[90779](#) , [90715](#) , [90814](#)

Application Tooling | FAQ

Tooling specifications and manuals are found by selecting the products below. Crimp Height Specifications are then contained in the Application Tooling Specification document.

Global

Description

Product #

Extractor Tool for [621006000](#)
 Connectors

This document was generated on 08/26/2021

PLEASE CHECK WWW.MOLEX.COM FOR LATEST PART INFORMATION