

## 1 A Surface Mount Schottky Barrier Diode

## 1N5817WS~1N5819WS

### PINNING

PIN	DESCRIPTION
1	Cathode
2	Anode

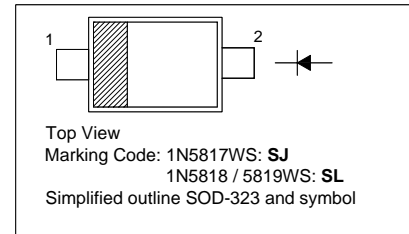

### Absolute Maximum Ratings ( $T_a = 25\text{ }^\circ\text{C}$ )

Parameter	Symbol	Value	Unit
Reverse Voltage	$V_R$	1N5817WS	20
		1N5818WS	30
		1N5819WS	40
Average Forward Rectified Current	$I_{F(AV)}$	1	A
Non-Repetitive Peak Forward Surge Current ( $t = 8.3\text{ ms}$ )	$I_{FSM}$	9	A
Power Dissipation	$P_{tot}$	450	mW
Operating Temperature Range	$T_j$	- 55 to + 125	$^\circ\text{C}$
Storage Temperature Range	$T_{stg}$	- 55 to + 125	$^\circ\text{C}$

### Characteristics at $T_a = 25\text{ }^\circ\text{C}$

Parameter	Symbol	Min.	Max.	Unit
Reverse Breakdown Voltage at $I_R = 1\text{ mA}$	$V_{(BR)R}$	1N5817WS	20	-
		1N5818WS	30	-
		1N5819WS	40	-
Forward Voltage at $I_F = 1\text{ A}$  at $I_F = 3\text{ A}$	$V_F$	1N5817WS	-	0.45
		1N5818WS	-	0.55
		1N5819WS	-	0.6
		1N5817WS	-	0.75
		1N5818WS	-	0.875
		1N5819WS	-	0.9
Reverse Voltage Leakage Current at $V_R = 20\text{ V}$ at $V_R = 30\text{ V}$ at $V_R = 40\text{ V}$	$I_R$	1N5817WS	-	1
		1N5818WS	-	1
		1N5819WS	-	1
Total Capacitance at $V_R = 4\text{ V}$ , $f = 1\text{ MHz}$	$C_{tot}$	-	120	pF



# 1N5817WS~1N5819WS

Fig. 1 - Forward Current Derating Curve

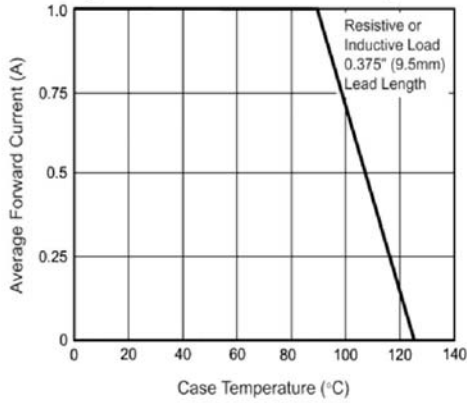

Fig. 2 - Maximum Non-Repetitive Peak Forward Surge Current

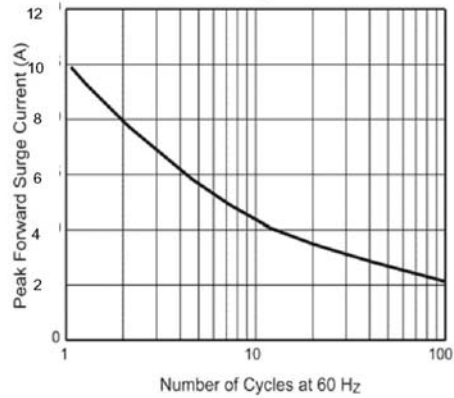

Fig. 3 - Typical Instantaneous Forward Characteristics

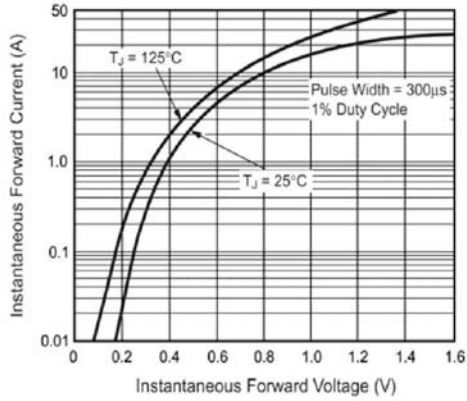

Fig. 4 - Typical Reverse Characteristics

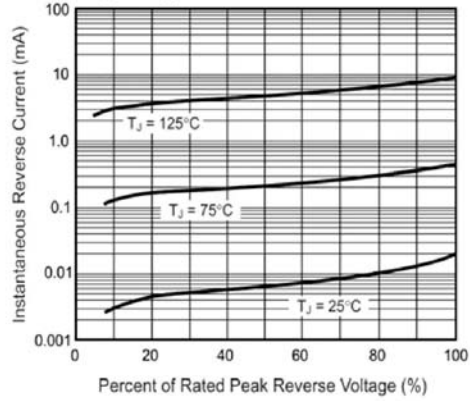

Fig. 5 - Typical Junction Capacitance

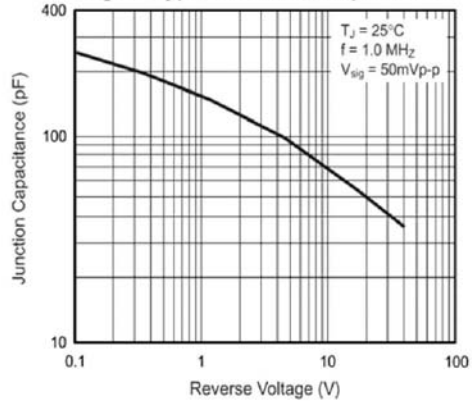
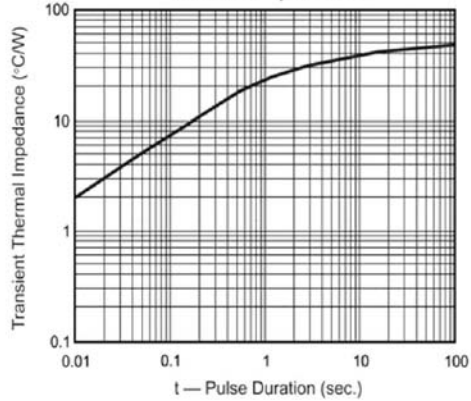

Fig. 6 - Typical Transient Thermal Impedance





# PACKAGE OUTLINE 1N5817WS~1N5819WS

Plastic surface mounted package; 2 leads

SOD-323

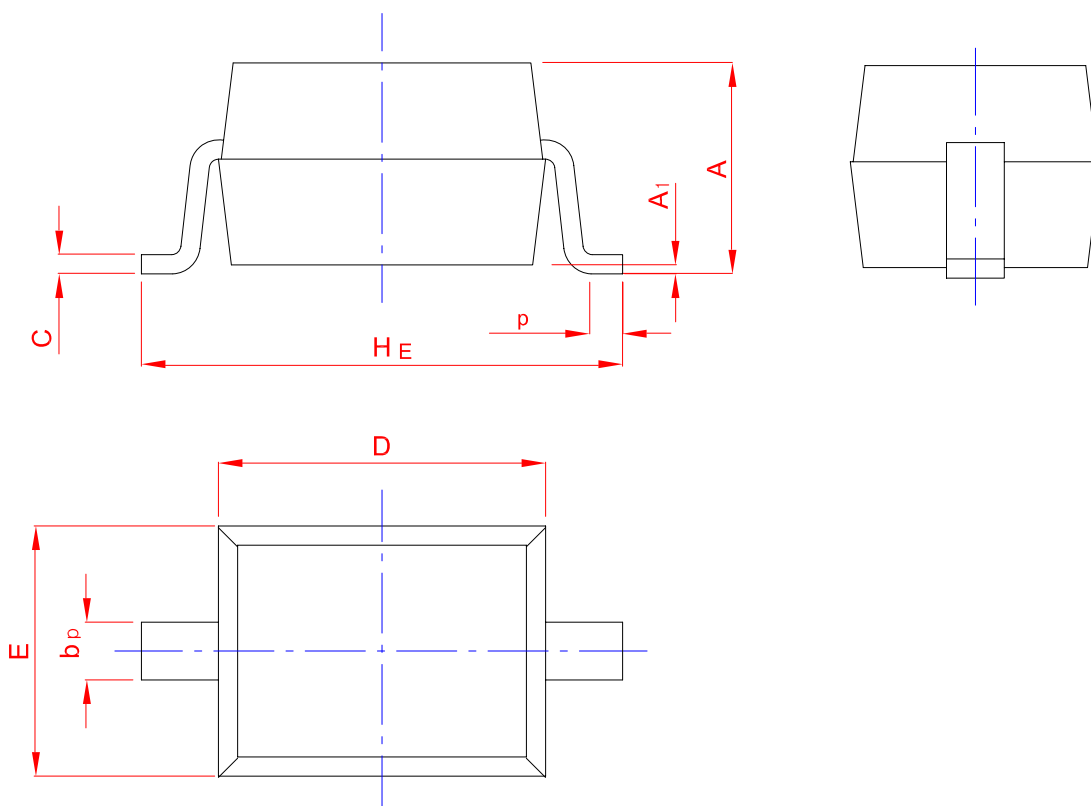
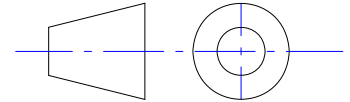

UNIT	A	bp	C	D	E	HE	A1	Lp
mm	1.20	0.40	0.15	1.80	1.35	2.80	0.10	0.50
	0.90	0.25	0.10	1.60	1.15	2.30	0.01	0.20