

20A SCHOTTKY BARRIER RECTIFIER

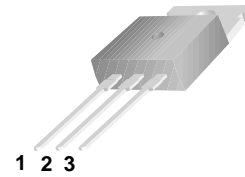

Features

- Low power loss, high efficiency. High surge capacity.
- For use in low voltage, high frequency inverters, free wheeling, and polarity protection applications.
- Metal silicon junction, majority carrier conduction.
- High current capacity, low forward voltage drop.
- Guard ring for over voltage protection.

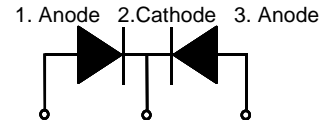

TO-220

Absolute Maximum Ratings*

$T_A = 25^\circ\text{C}$ unless otherwise noted

Symbol	Parameter	Value				Units
		2035CT	2045CT	2050CT	2060CT	
V_{RRM}	Maximum Repetitive Reverse Voltage	35	45	50	60	V
$I_{F(AV)}$	Average Rectified Forward Current .375" lead length @ $T_A = 135^\circ\text{C}$	20				A
I_{FSM}	Non-repetitive Peak Forward Surge Current 8.3 ms Single Half-Sine-Wave	150				A
T_{stg}	Storage Temperature Range	-65 to +175				$^\circ\text{C}$
T_J	Operating Junction Temperature	-65 to +150				$^\circ\text{C}$

*These ratings are limiting values above which the serviceability of any semiconductor device may be impaired.

Thermal Characteristics

Symbol	Parameter	Value	Units
P_D	Power Dissipation	2.0	W
$R_{\theta JA}$	Thermal Resistance, Junction to Ambient *	60	$^\circ\text{C}/\text{W}$
$R_{\theta JL}$	Thermal Resistance, Junction to Lead	2.0	$^\circ\text{C}/\text{W}$

Electrical Characteristics

$T_A = 25^\circ\text{C}$ unless otherwise noted

Symbol	Parameter	Device				Units
		2035CT	2045CT	2050CT	2060CT	
V_F	Forward Voltage $I_F = 10\text{ A}, T_C = 25^\circ\text{C}$ $I_F = 10\text{ A}, T_C = 125^\circ\text{C}$ $I_F = 20\text{ A}, T_C = 25^\circ\text{C}$ $I_F = 20\text{ A}, T_C = 125^\circ\text{C}$	-		0.80		V
		0.57		0.70		V
		0.84		0.95		V
		0.72		0.85		V
I_R	Reverse Current @ rated V_R $T_A = 25^\circ\text{C}$ $T_A = 125^\circ\text{C}$	0.1		0.15		mA
		15		150		mA
I_{RRM}	Peak Repetitive Reverse Surge Current 2.0 μs Pulse Width, $f = 1.0\text{ KHz}$	1.0		0.5		A

Typical Characteristics

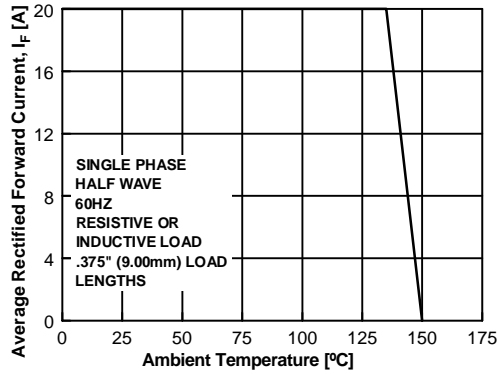

Figure 1. Forward Current Derating Curve

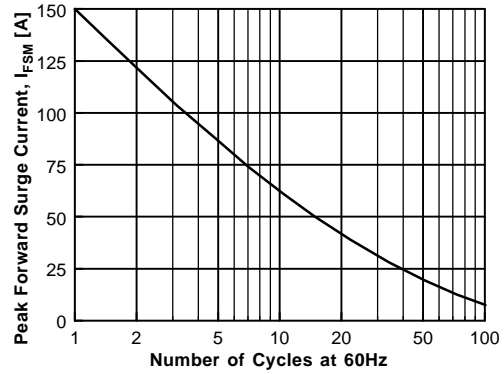

Figure 2. Non-Repetitive Surge Current

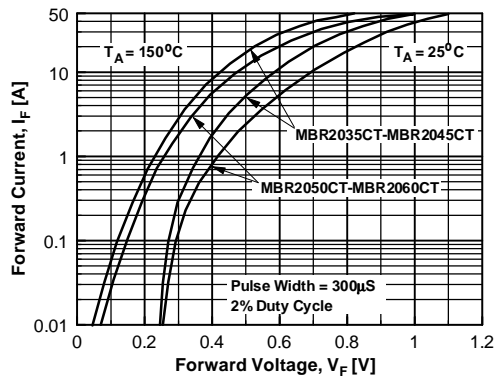

Figure 3. Forward Voltage Characteristics

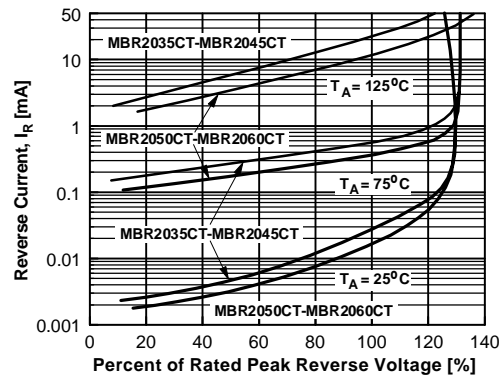

Figure 4. Reverse Current vs Reverse Voltage

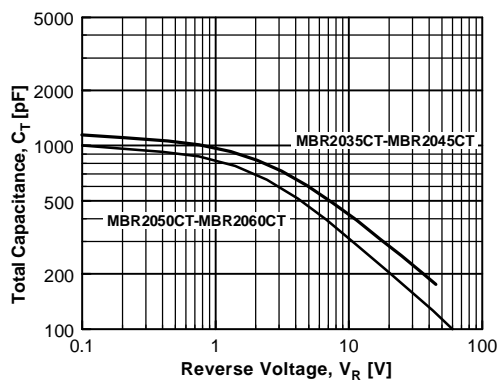

Figure 5. Total Capacitance

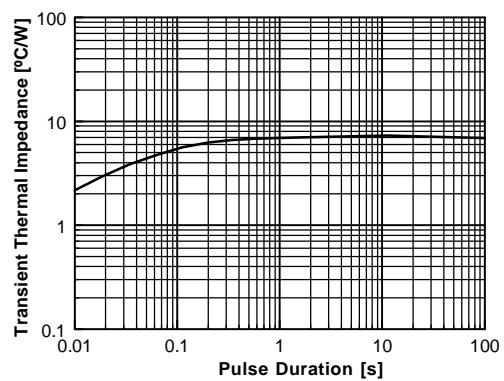
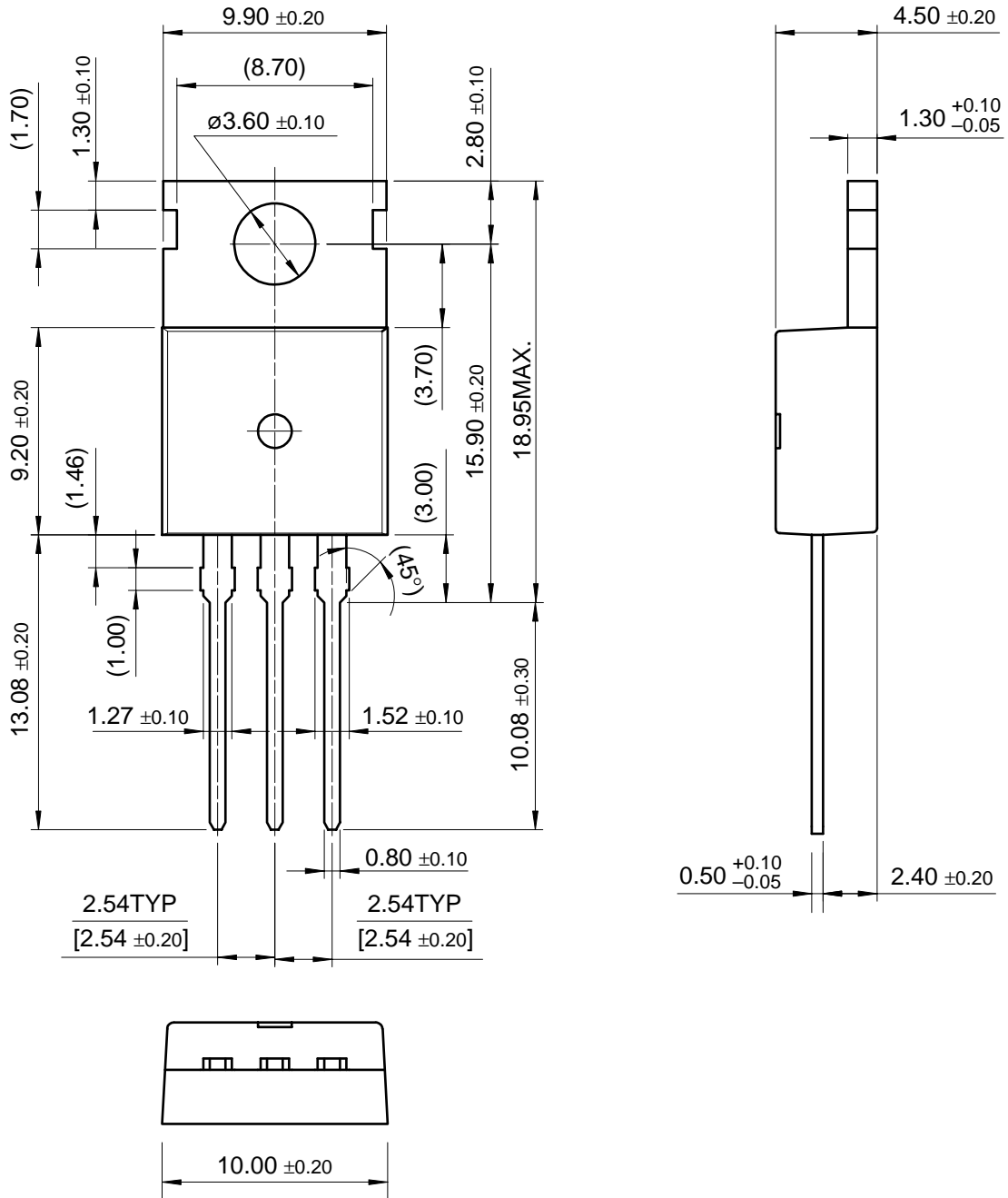

Figure 6. Thermal Impedance Characteristics

Package Dimension

TO-220



Dimensions in Millimeters