

Multipoint RS485/RS422 Transceivers/Repeaters

Check for Samples: [DS3695](#), [DS3695T](#), [DS3696](#), [DS3697](#)

FEATURES

- Meets EIA standard RS485 for Multipoint Bus Transmission and is Compatible with RS-422
- 15 ns Driver Propagation Delays with 2 ns Skew (Typical)
- Single +5V supply
- -7V to +12V Bus Common Mode Range Permits ±7V Ground Difference Between Devices on the Bus
- Thermal Shutdown Protection
- High Impedance to Bus with Driver in TRI-STATE or with Power Off, Over the Entire Common Mode Range Allows the Unused Devices on the Bus to be Powered Down
- Combined Impedance of a Driver Output and Receiver Input is Less than one RS485 Unit Load, Allowing up to 32 Transceivers on the Bus
- 70 mV Typical Receiver Hysteresis

DESCRIPTION

The DS3695, DS3696, and DS3697 are high speed differential TRI-STATE bus/line transceivers/repeaters designed to meet the requirements of EIA standard RS485 with extended common mode range (+12V to -7V), for multipoint data transmission.

The driver and receiver outputs feature TRI-STATE capability. The driver outputs remain in TRI-STATE over the entire common mode range of +12V to -7V. Bus faults that cause excessive power dissipation within the device trigger a thermal shutdown circuit, which forces the driver outputs into the high impedance state. The DS3696 provides an output pin TS (thermal shutdown) which reports the occurrence of the thermal shutdown of the device. This is an "open collector" pin with an internal 10 kΩ pull-up resistor. This allows the line fault outputs of several devices to be wire OR-ed.

Both AC and DC specifications are specified over the 0°C to 70°C temperature and 4.75V to 5.25V supply voltage range.

Connection and Logic Diagrams

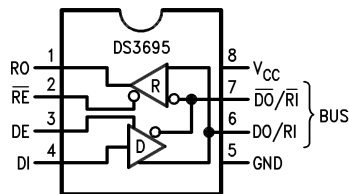

Figure 1. PDIP (Top View)
See Package Number P (R-PDIP-T8)

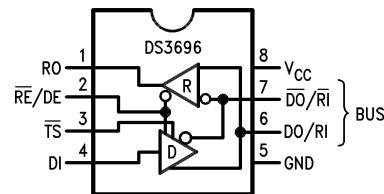

Figure 2. PDIP (Top View)
See Package Number P (R-PDIP-T8)

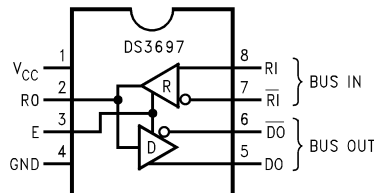

Figure 3. PDIP (Top View)
See Package Number P (R-PDIP-T8)

\overline{TS} pin was \overline{LF} (Line Fault) in previous data sheets and reports the occurrence of a thermal shutdown of the device.



Please be aware that an important notice concerning availability, standard warranty, and use in critical applications of Texas Instruments semiconductor products and disclaimers thereto appears at the end of this data sheet.

All trademarks are the property of their respective owners.



These devices have limited built-in ESD protection. The leads should be shorted together or the device placed in conductive foam during storage or handling to prevent electrostatic damage to the MOS gates.

Absolute Maximum Ratings ⁽¹⁾⁽²⁾

	VALUE	UNIT
Supply Voltage, V_{CC}	7	V
Control Input Voltages	7	V
Driver Input Voltage	7	V
Driver Output Voltages	+15/-10	V
Receiver Input Voltages (DS3695, DS3696)	+15/-10	V
Receiver Common Mode Voltage (DS3697)	± 25	V
Receiver Output Voltage	5.5	V
Continuous Power Dissipation @ 25°C - N Package ⁽³⁾	1.07	W
Storage Temperature Range	-65 to +150	°C
Lead Temperature (Soldering, 4 sec.)	260	°C

- (1) "Absolute Maximum Ratings" are those beyond which the safety of the device cannot be verified. They are not meant to imply that the device should be operated at these limits. The tables of "Electrical Characteristics" provide conditions for actual device operation.
- (2) If Military/Aerospace specified devices are required, please contact the TI Sales Office/ Distributors for availability and specifications.
- (3) All typicals are given for $V_{CC} = 5V$ and $T_A = 25^\circ C$.

Recommended Operating Conditions

		Min	Max	Units
Supply Voltage, V_{CC}		4.75	5.25	V
Bus Voltage		-7	+12	V
Operating Free Air Temp. (T_A)	Commercial	0	+70	°C
	Industrial	-40	+85	°C

Electrical Characteristics ⁽¹⁾⁽²⁾

0°C ≤ T_A ≤ +70°C, 4.75V < V_{CC} < 5.25V unless otherwise specified

Symbol	Parameter	Conditions	Min	Typ	Max	Units	
V_{OD1}	Differential Driver Output Voltage (Unloaded)	$I_O = 0$			5	V	
V_{OD2}	Differential Driver Output Voltage (with Load)	See Figure 4	R = 50Ω; (RS-422) ⁽³⁾			V	
				R = 27Ω; (RS-485)	1.5		V
ΔV_{OD}	Change in Magnitude of Driver Differential Output Voltage for Complementary Output States	See Figure 4	R = 27Ω		0.2	V	
V_{OC}	Driver Common Mode Output Voltage				3.0	V	
$\Delta V_{OC} $	Change in Magnitude of Driver Common Mode Output Voltage for Complementary Output States				0.2	V	
V_{IH}	Input High Voltage	DI, DE, \overline{RE} , E, \overline{RE}/DE	2			V	
V_{IL}	Input Low Voltage				0.8	V	
V_{CL}	Input Clamp Voltage				-1.5	V	
I_{IL}	Input Low Current				-200	μA	
I_{IH}	Input High Current				20	μA	
I_{IN}	Input Current	DO/RI, $\overline{DO}/\overline{RI}$ RI, \overline{RI}	$V_{CC} = 0V$ or 5.25V \overline{RE}/DE or $DE = 0V$	$V_{IN} = 12V$		+1.0	mA
				$V_{IN} = -7V$		-0.8	mA

- (1) All currents into device pins are positive; all currents out of device pins are negative. All voltages are referenced to device ground unless otherwise specified.
- (2) All typicals are given for $V_{CC} = 5V$ and $T_A = 25^\circ C$.
- (3) All limits for which derate linearly at 11.1 mW/°C to 570 mW at 70°C is applied must be derated by 10% for DS3695T and DS3696T. Other parameters remain the same for this extended temperature range device (-40°C ≤ T_A ≤ +85°C).

Electrical Characteristics ⁽¹⁾⁽²⁾ (continued)
 $0^{\circ}\text{C} \leq T_A \leq +70^{\circ}\text{C}$, $4.75\text{V} < V_{CC} < 5.25\text{V}$ unless otherwise specified

Symbol	Parameter	Conditions	Min	Typ	Max	Units	
I_{OZD}	TRI-STATE Current DS3697 & DS3698	DO, \overline{DO} $V_{CC} = 0\text{V}$ or 5.25V , $E = 0\text{V}$ $-7\text{V} < V_O < +12\text{V}$			± 100	μA	
V_{TH}	Differential Input Threshold Voltage for Receiver	$-7\text{V} \leq V_{CM} \leq +12\text{V}$	-0.2		+0.2	V	
ΔV_{TH}	Receiver Input Hysteresis	$V_{CM} = 0\text{V}$		70		mV	
V_{OH}	Receiver Output High Voltage	$I_{OH} = -400\ \mu\text{A}$	2.4			V	
V_{OL}	Output Low Voltage	RO			0.5	V	
		\overline{TS}			0.45	V	
I_{OZR}	OFF-State (High Impedance) Output Current at Receiver	$V_{CC} = \text{Max}$ $0.4\text{V} \leq V_O \leq 2.4\text{V}$			± 20	μA	
R_{IN}	Receiver Input Resistance	$-7\text{V} \leq V_{CM} \leq +12\text{V}$	12			k Ω	
I_{CC}	Supply Current	No Load ⁽³⁾	Driver Outputs Enabled		42	60	mA
			Driver Outputs Disabled		27	40	mA
I_{OSD}	Driver Short-Circuit Output Current	$V_O = -7\text{V}$ ⁽³⁾			-250	mA	
		$V_O = +12\text{V}$ ⁽³⁾			+250	mA	
I_{OSR}	Receiver Short-Circuit Output Current	$V_O = 0\text{V}$	-15		-85	mA	

Receiver Switching Characteristics ⁽¹⁾⁽²⁾
 $0^{\circ}\text{C} \leq T_A \leq +70^{\circ}\text{C}$, $4.75\text{V} < V_{CC} < 5.25\text{V}$ unless otherwise specified (Figure 5, Figure 6, Figure 7)

Symbol	Conditions	Min	Typ	Max	Units
t_{PLH}	$C_L = 15\ \text{pF}$	15	25	37	ns
t_{PHL}	S1 and S2	15	25	37	ns
$ t_{PLH} - t_{PHL} $	Closed	0			ns
t_{PLZ}	$C_L = 15\ \text{pF}$, S2 Open	5	12	16	ns
t_{PHZ}	$C_L = 15\ \text{pF}$, S1 Open	5	12	16	ns
t_{PZL}	$C_L = 15\ \text{pF}$, S2 Open	7	15	20	ns
t_{PZH}	$C_L = 15\ \text{pF}$, S1 Open	7	15	20	ns

 (1) All typicals are given for $V_{CC} = 5\text{V}$ and $T_A = 25^{\circ}\text{C}$.

(2) Switching Characteristics apply for DS3695, DS3695T, DS3696, DS3697 only.

Driver Switching Characteristics
 $0^{\circ}\text{C} \leq T_A \leq +70^{\circ}\text{C}$, $4.75\text{V} < V_{CC} < 5.25\text{V}$ unless otherwise specified

Symbol	Conditions	Min	Typ	Max	Units
SINGLE ENDED CHARACTERISTICS (Figure 8, Figure 9, Figure 10)					
t_{PLH}	$R_{L\text{DIFF}} = 60\ \Omega$	9	15	22	ns
t_{PHL}	$C_{L1} = C_{L2} = 100\ \text{pF}$	9	15	22	ns
$t_{\text{SKEW}} t_{PLH} - t_{PHL} $			2	8	ns
t_{PLZ}	$C_L = 15\ \text{pF}$, S2 Open	7	15	30	ns
t_{PHZ}	$C_L = 15\ \text{pF}$, S1 Open	7	15	30	ns
t_{PZL}	$C_L = 100\ \text{pF}$, S2 Open	30	35	50	ns
t_{PZH}	$C_L = 100\ \text{pF}$, S1 Open	30	35	50	ns
DIFFERENTIAL CHARACTERISTICS (Figure 8 Figure 11)					
t_r, t_f	$R_{L\text{DIFF}} = 60\ \Omega$ $C_{L1} = C_{L2} = 100\ \text{pF}$	6	10	18	ns

AC Test Circuits and Switching Waveforms

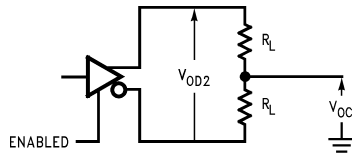

Figure 4. Driver V_{OD} and V_{OC}

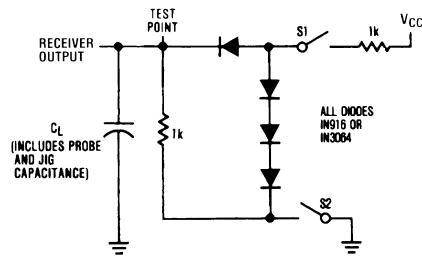
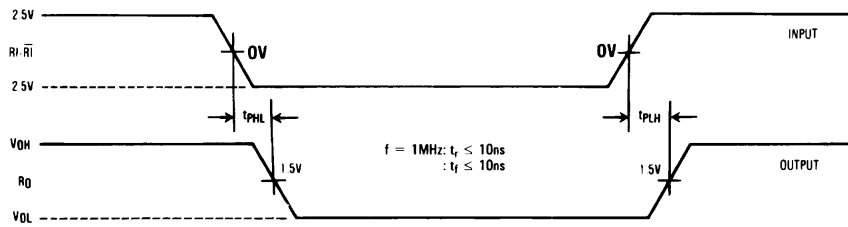

Figure 5. Receiver Propagation Delay Test Circuit



Note: Differential input voltage may be realized by grounding $\bar{R}I$ and pulsing R_I between +2.5V and -2.5V.

Figure 6. Receiver Input-to-Output Propagation Delay Timing

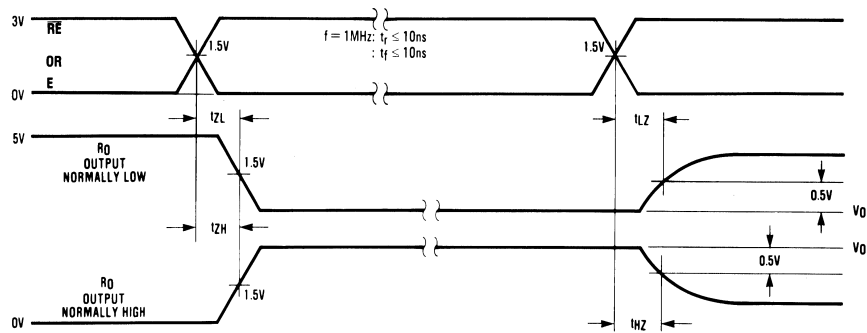
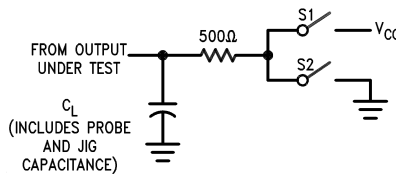

Figure 7. Receiver Enable/Disable Propagation Delay Timing



Note: Unless otherwise specified the switches are closed.

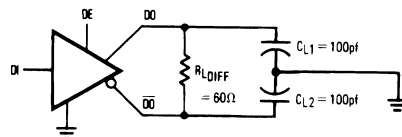
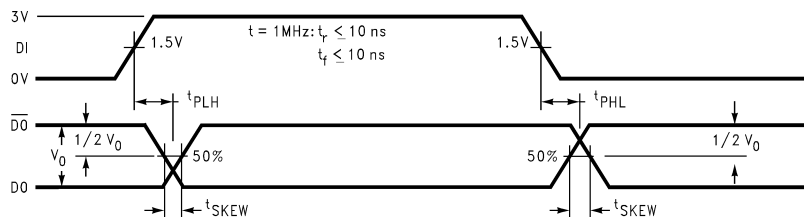

Figure 8. Driver Propagation Delay and Transition Time Test Circuits



Note: t_{PLH} and t_{PHL} are measured to the respective 50% points. t_{SKEW} is the difference between propagation delays of the complementary outputs.

Figure 9. Driver Input-to-Output Propagation Delay Timing (Single-Ended)

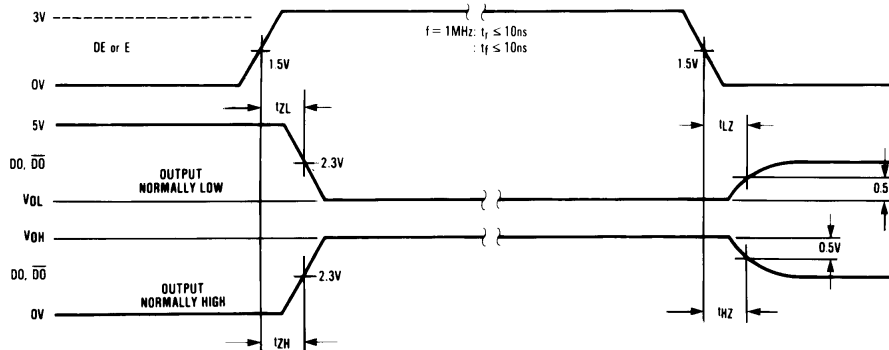

Figure 10. Driver Enable/Disable Propagation Delay Timing

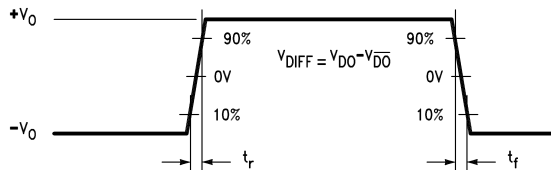

Figure 11. Driver Differential Transition Timing

Function Tables

Table 1. DS3695/DS3696 Transmitting⁽¹⁾

Inputs			Thermal Shutdown	Outputs		
\overline{RE}	DE	DI		\overline{DO}	DO	\overline{TS}^* (DS3696 Only)
X	1	1	OFF	0	1	H
X	1	0	OFF	1	0	H
X	0	X	OFF	Z	Z	H
X	1	X	ON	Z	Z	L

- (1) X—Don't care condition
 Z—High impedance state
 * \overline{TS} is an "open collector" output with an on-chip 10 k Ω pull-up resistor that reports the occurrence of a thermal shutdown of the device.

Table 2. DS3695/DS3696 Receiving⁽¹⁾

Inputs			Outputs	
\overline{RE}	DE	RI- \overline{RI}	RO	\overline{TS}^* (DS3696 Only)
0	0	$\geq +0.2V$	1	H
0	0	$\leq -0.2V$	0	H
1	0	X	Z	H

- (1) X—Don't care condition
 Z—High impedance state
 * \overline{TS} is an "open collector" output with an on-chip 10 k Ω pull-up resistor that reports the occurrence of a thermal shutdown of the device.

Table 3. DS3697⁽¹⁾

Inputs		Thermal Shutdown	Outputs		
E	RI- \overline{RI}		\overline{DO}	DO	RO (DS3697 Only)
1	$\geq +0.2V$	OFF	0	1	1
1	$\leq -0.2V$	OFF	1	0	0
0	X	OFF	Z	Z	Z
1	$\geq +0.2V$	ON	Z	Z	1
1	$\leq -0.2V$	ON	Z	Z	0

- (1) X—Don't care condition
 Z—High impedance state
 * \overline{TS} is an "open collector" output with an on-chip 10 k Ω pull-up resistor that reports the occurrence of a thermal shutdown of the device.

Typical Application

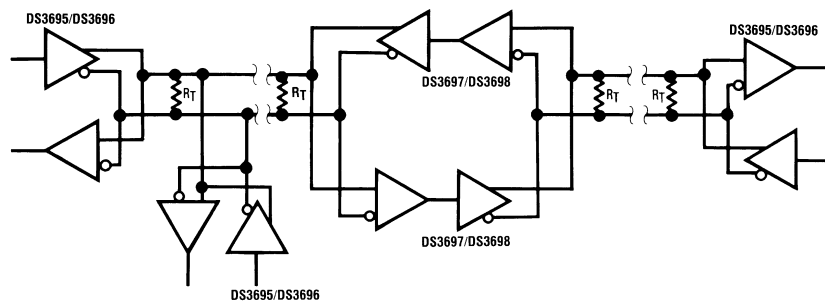

Note: Repeater control logic not shown

Typical Performance Characteristics

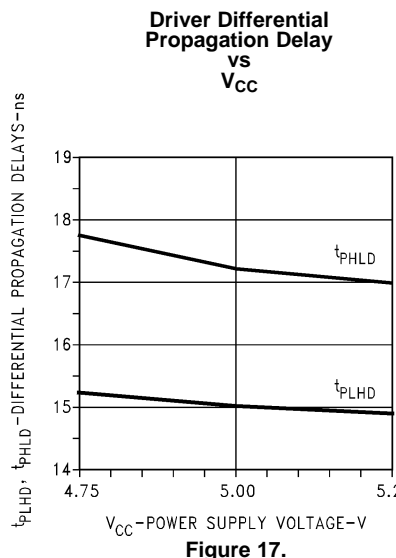
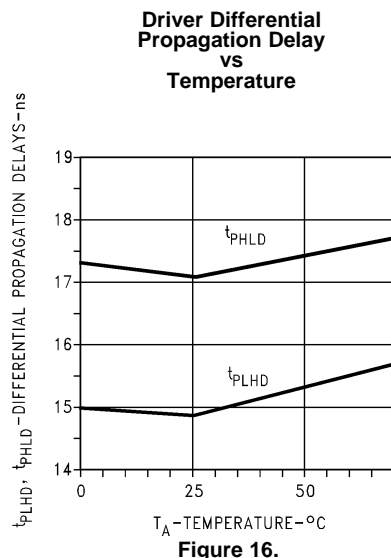
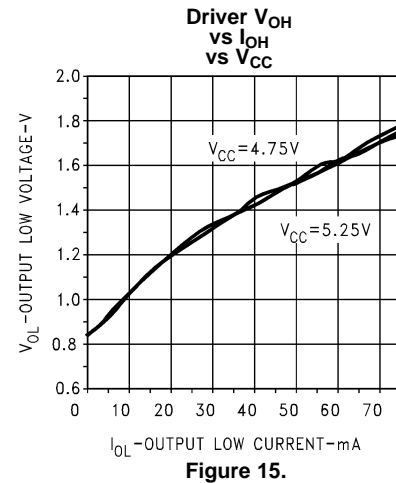
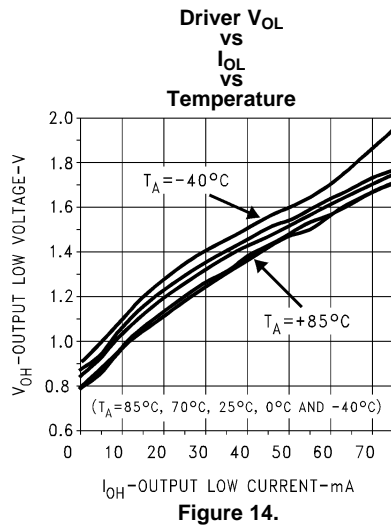
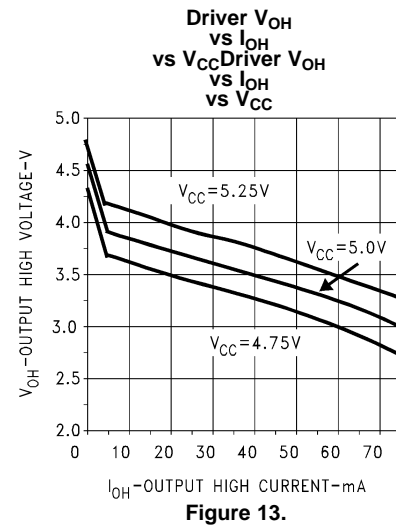
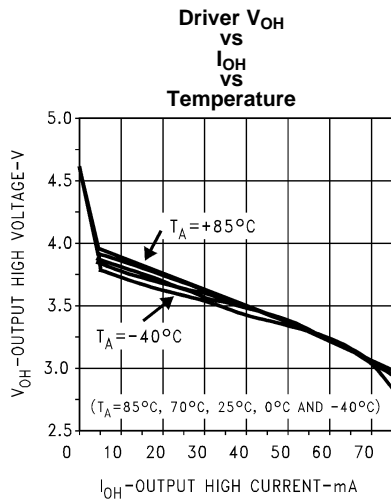

Typical Performance Characteristics (continued)

Driver Single-Ended Propagation Delay vs Temperature

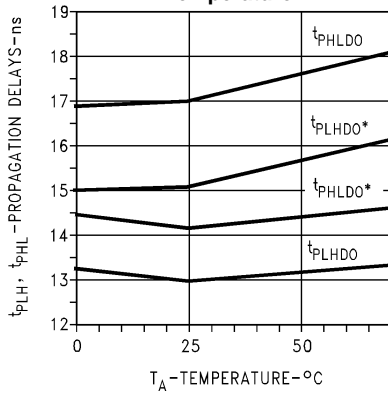

Figure 18.

Driver Single-Ended Propagation Delay vs VCC

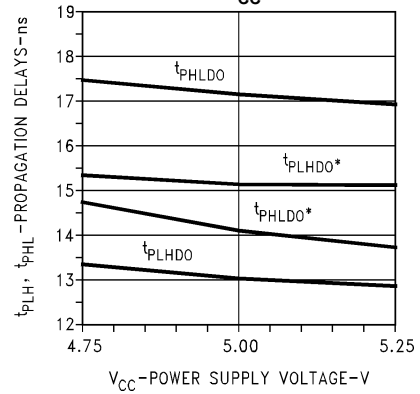

Figure 19.

Driver Transition Time vs Temperature

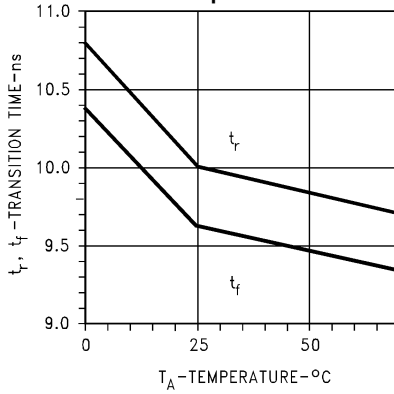

Figure 20.

Driver Transition Time vs VCC

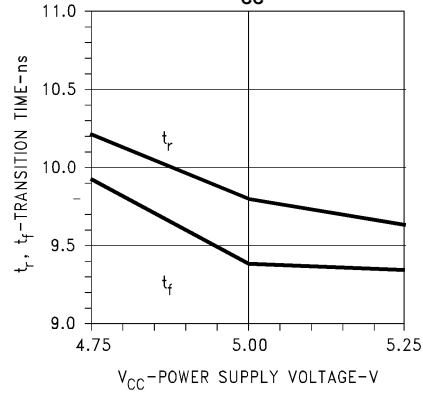

Figure 21.

Cable Length vs Data Rate

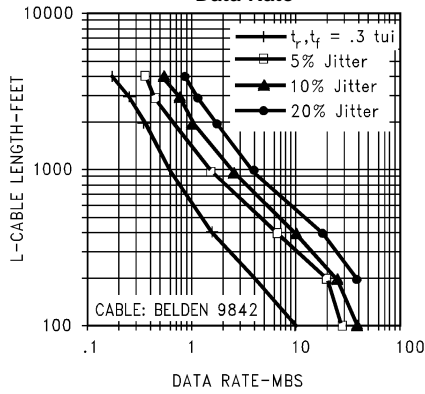

Figure 22.

Supply Current vs Temperature

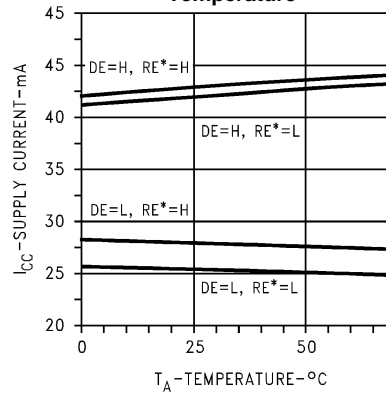

Figure 23.

Typical Performance Characteristics (continued)

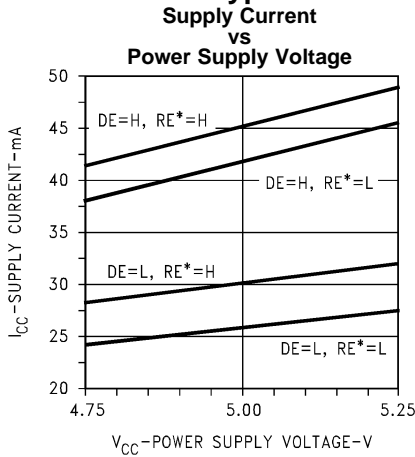

Figure 24.

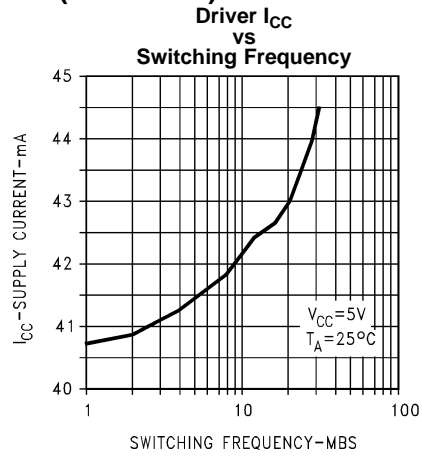

Figure 25.

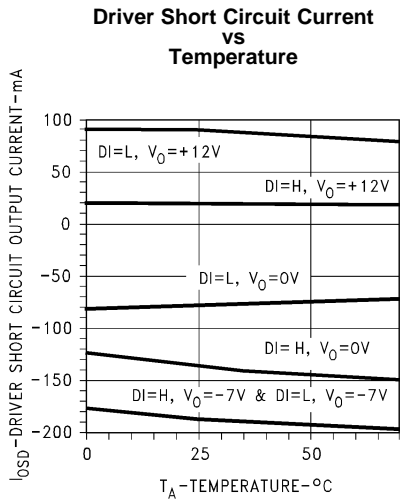

Figure 26.

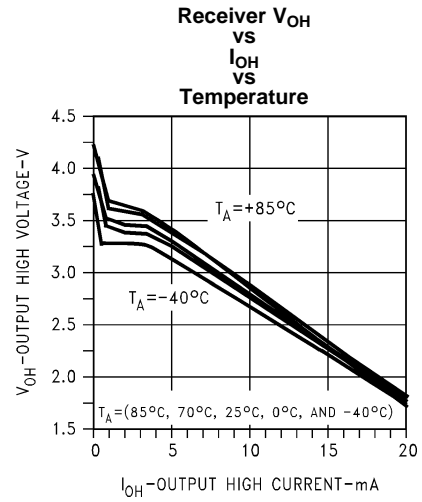

Figure 27.

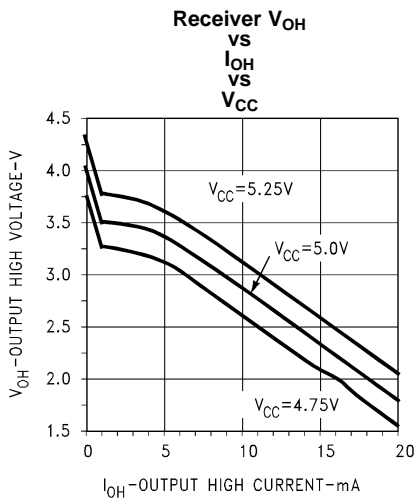

Figure 28.

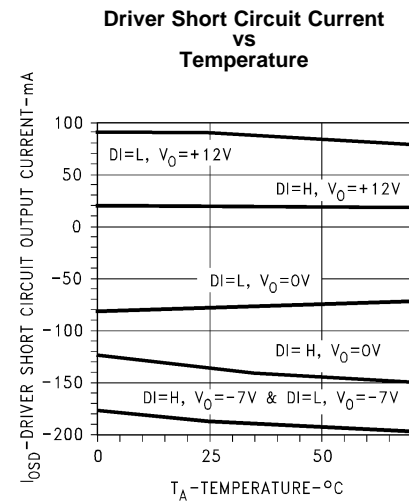
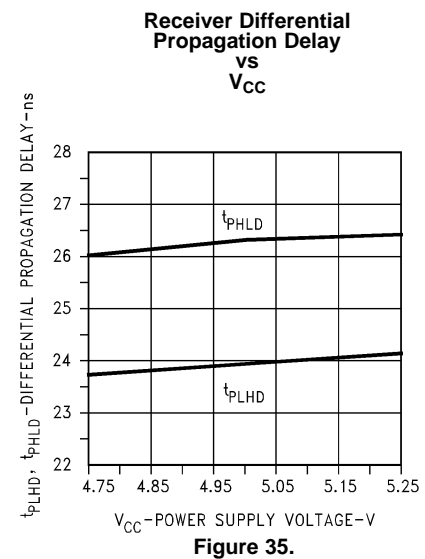
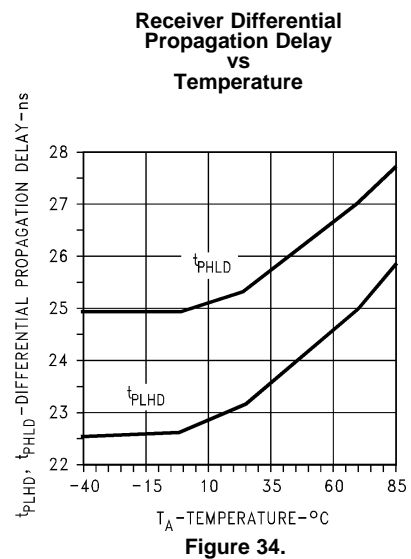
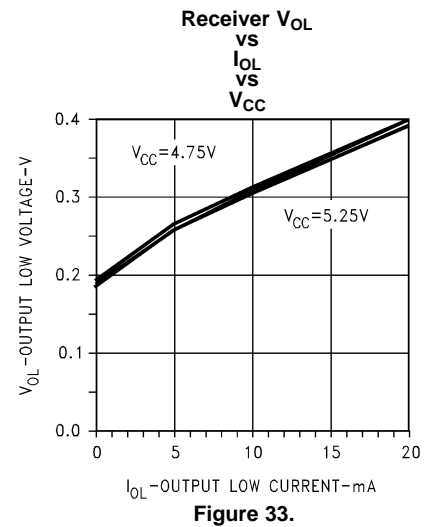
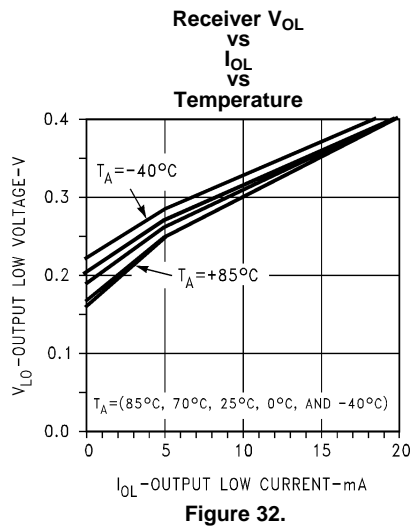
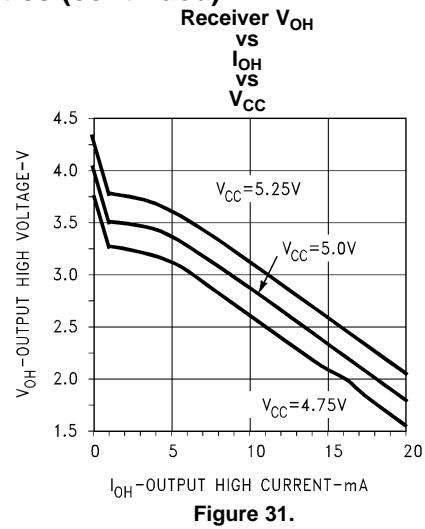
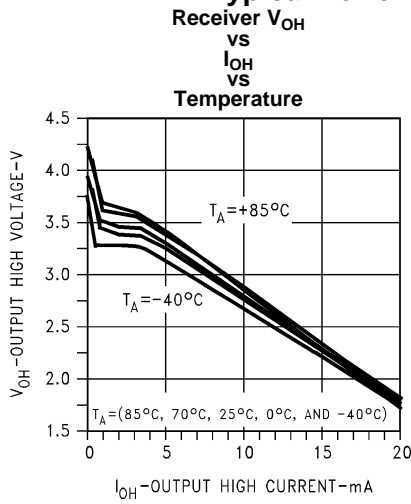

Figure 29.

Typical Performance Characteristics (continued)



Typical Performance Characteristics (continued)

Receiver Short Circuit Current vs Temperature

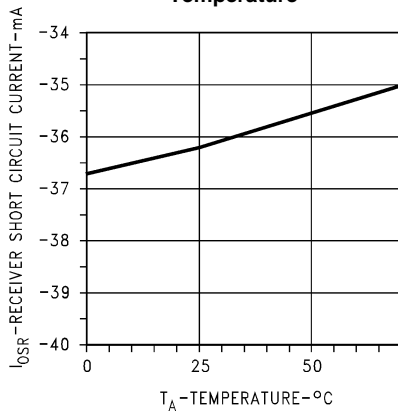

Figure 36.

Receiver Short Circuit Current vs Power Supply

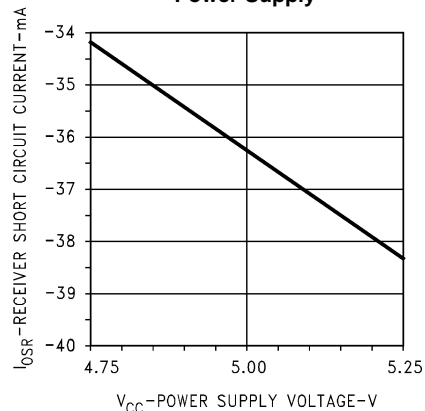

Figure 37.

Receiver Non-Inverting Input Current vs Temperature

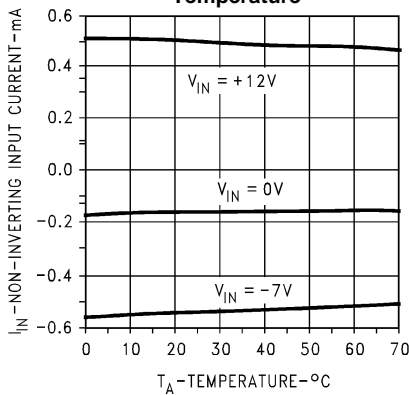

Figure 38.

Receiver Non-Inverting Input Current vs Power Supply Voltage

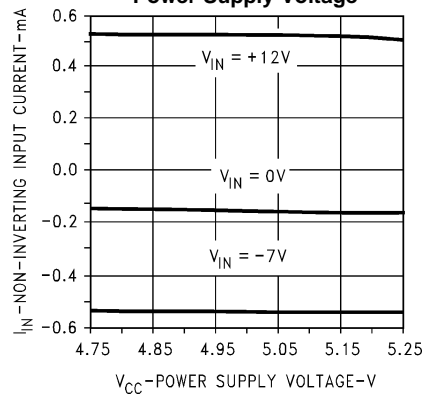

Figure 39.

Receiver Inverting Input Current vs Temperature

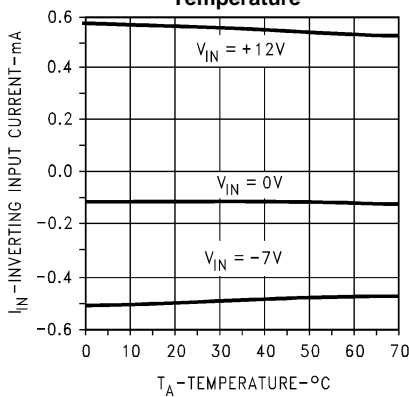

Figure 40.

Receiver Inverting Input Current vs Power Supply Voltage

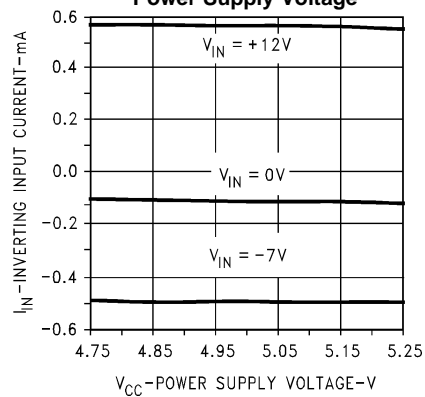
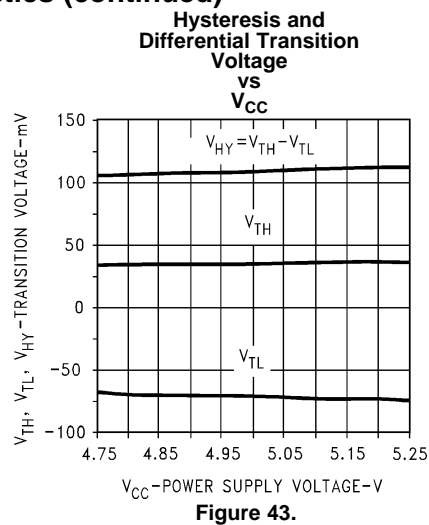
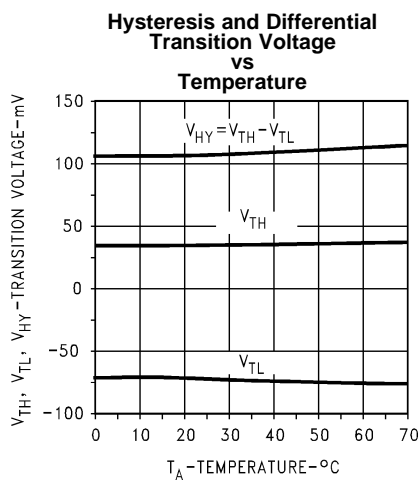

Figure 41.

Typical Performance Characteristics (continued)



REVISION HISTORY

Changes from Revision B (April 2013) to Revision C	Page
• Changed layout of National Data Sheet to TI format	11

PACKAGING INFORMATION

Orderable Device	Status (1)	Package Type	Package Drawing	Pins	Package Qty	Eco Plan (2)	Lead/Ball Finish (6)	MSL Peak Temp (3)	Op Temp (°C)	Device Marking (4/5)	Samples
DS3695N	NRND	PDIP	P	8	40	TBD	Call TI	Call TI	0 to 70	DS3695N	
DS3695N/NOPB	ACTIVE	PDIP	P	8	40	Green (RoHS & no Sb/Br)	SN CU SN	Level-1-NA-UNLIM	0 to 70	DS3695N	Samples
DS3695TN	NRND	PDIP	P	8	40	TBD	Call TI	Call TI	-40 to 85	DS 3695TN	
DS3695TN/NOPB	ACTIVE	PDIP	P	8	40	Green (RoHS & no Sb/Br)	SN CU SN	Level-1-NA-UNLIM	-40 to 85	DS 3695TN	Samples

(1) The marketing status values are defined as follows:

ACTIVE: Product device recommended for new designs.

LIFEBUY: TI has announced that the device will be discontinued, and a lifetime-buy period is in effect.

NRND: Not recommended for new designs. Device is in production to support existing customers, but TI does not recommend using this part in a new design.

PREVIEW: Device has been announced but is not in production. Samples may or may not be available.

OBSELETE: TI has discontinued the production of the device.

(2) Eco Plan - The planned eco-friendly classification: Pb-Free (RoHS), Pb-Free (RoHS Exempt), or Green (RoHS & no Sb/Br) - please check <http://www.ti.com/productcontent> for the latest availability information and additional product content details.

TBD: The Pb-Free/Green conversion plan has not been defined.

Pb-Free (RoHS): TI's terms "Lead-Free" or "Pb-Free" mean semiconductor products that are compatible with the current RoHS requirements for all 6 substances, including the requirement that lead not exceed 0.1% by weight in homogeneous materials. Where designed to be soldered at high temperatures, TI Pb-Free products are suitable for use in specified lead-free processes.

Pb-Free (RoHS Exempt): This component has a RoHS exemption for either 1) lead-based flip-chip solder bumps used between the die and package, or 2) lead-based die adhesive used between the die and leadframe. The component is otherwise considered Pb-Free (RoHS compatible) as defined above.

Green (RoHS & no Sb/Br): TI defines "Green" to mean Pb-Free (RoHS compatible), and free of Bromine (Br) and Antimony (Sb) based flame retardants (Br or Sb do not exceed 0.1% by weight in homogeneous material)

(3) MSL, Peak Temp. - The Moisture Sensitivity Level rating according to the JEDEC industry standard classifications, and peak solder temperature.

(4) There may be additional marking, which relates to the logo, the lot trace code information, or the environmental category on the device.

(5) Multiple Device Markings will be inside parentheses. Only one Device Marking contained in parentheses and separated by a "~" will appear on a device. If a line is indented then it is a continuation of the previous line and the two combined represent the entire Device Marking for that device.

(6) Lead/Ball Finish - Orderable Devices may have multiple material finish options. Finish options are separated by a vertical ruled line. Lead/Ball Finish values may wrap to two lines if the finish value exceeds the maximum column width.

Important Information and Disclaimer: The information provided on this page represents TI's knowledge and belief as of the date that it is provided. TI bases its knowledge and belief on information provided by third parties, and makes no representation or warranty as to the accuracy of such information. Efforts are underway to better integrate information from third parties. TI has taken and continues to take reasonable steps to provide representative and accurate information but may not have conducted destructive testing or chemical analysis on incoming materials and chemicals. TI and TI suppliers consider certain information to be proprietary, and thus CAS numbers and other limited information may not be available for release.

In no event shall TI's liability arising out of such information exceed the total purchase price of the TI part(s) at issue in this document sold by TI to Customer on an annual basis.

P (R-PDIP-T8)

PLASTIC DUAL-IN-LINE PACKAGE



- NOTES:
- A. All linear dimensions are in inches (millimeters).
 - B. This drawing is subject to change without notice.
 - C. Falls within JEDEC MS-001 variation BA.

IMPORTANT NOTICE

Texas Instruments Incorporated and its subsidiaries (TI) reserve the right to make corrections, enhancements, improvements and other changes to its semiconductor products and services per JESD46, latest issue, and to discontinue any product or service per JESD48, latest issue. Buyers should obtain the latest relevant information before placing orders and should verify that such information is current and complete. All semiconductor products (also referred to herein as "components") are sold subject to TI's terms and conditions of sale supplied at the time of order acknowledgment.

TI warrants performance of its components to the specifications applicable at the time of sale, in accordance with the warranty in TI's terms and conditions of sale of semiconductor products. Testing and other quality control techniques are used to the extent TI deems necessary to support this warranty. Except where mandated by applicable law, testing of all parameters of each component is not necessarily performed.

TI assumes no liability for applications assistance or the design of Buyers' products. Buyers are responsible for their products and applications using TI components. To minimize the risks associated with Buyers' products and applications, Buyers should provide adequate design and operating safeguards.

TI does not warrant or represent that any license, either express or implied, is granted under any patent right, copyright, mask work right, or other intellectual property right relating to any combination, machine, or process in which TI components or services are used. Information published by TI regarding third-party products or services does not constitute a license to use such products or services or a warranty or endorsement thereof. Use of such information may require a license from a third party under the patents or other intellectual property of the third party, or a license from TI under the patents or other intellectual property of TI.

Reproduction of significant portions of TI information in TI data books or data sheets is permissible only if reproduction is without alteration and is accompanied by all associated warranties, conditions, limitations, and notices. TI is not responsible or liable for such altered documentation. Information of third parties may be subject to additional restrictions.

Resale of TI components or services with statements different from or beyond the parameters stated by TI for that component or service voids all express and any implied warranties for the associated TI component or service and is an unfair and deceptive business practice. TI is not responsible or liable for any such statements.

Buyer acknowledges and agrees that it is solely responsible for compliance with all legal, regulatory and safety-related requirements concerning its products, and any use of TI components in its applications, notwithstanding any applications-related information or support that may be provided by TI. Buyer represents and agrees that it has all the necessary expertise to create and implement safeguards which anticipate dangerous consequences of failures, monitor failures and their consequences, lessen the likelihood of failures that might cause harm and take appropriate remedial actions. Buyer will fully indemnify TI and its representatives against any damages arising out of the use of any TI components in safety-critical applications.

In some cases, TI components may be promoted specifically to facilitate safety-related applications. With such components, TI's goal is to help enable customers to design and create their own end-product solutions that meet applicable functional safety standards and requirements. Nonetheless, such components are subject to these terms.

No TI components are authorized for use in FDA Class III (or similar life-critical medical equipment) unless authorized officers of the parties have executed a special agreement specifically governing such use.

Only those TI components which TI has specifically designated as military grade or "enhanced plastic" are designed and intended for use in military/aerospace applications or environments. Buyer acknowledges and agrees that any military or aerospace use of TI components which have **not** been so designated is solely at the Buyer's risk, and that Buyer is solely responsible for compliance with all legal and regulatory requirements in connection with such use.

TI has specifically designated certain components as meeting ISO/TS16949 requirements, mainly for automotive use. In any case of use of non-designated products, TI will not be responsible for any failure to meet ISO/TS16949.

Products

Audio	www.ti.com/audio
Amplifiers	amplifier.ti.com
Data Converters	dataconverter.ti.com
DLP® Products	www.dlp.com
DSP	dsp.ti.com
Clocks and Timers	www.ti.com/clocks
Interface	interface.ti.com
Logic	logic.ti.com
Power Mgmt	power.ti.com
Microcontrollers	microcontroller.ti.com
RFID	www.ti-rfid.com
OMAP Applications Processors	www.ti.com/omap
Wireless Connectivity	www.ti.com/wirelessconnectivity

Applications

Automotive and Transportation	www.ti.com/automotive
Communications and Telecom	www.ti.com/communications
Computers and Peripherals	www.ti.com/computers
Consumer Electronics	www.ti.com/consumer-apps
Energy and Lighting	www.ti.com/energy
Industrial	www.ti.com/industrial
Medical	www.ti.com/medical
Security	www.ti.com/security
Space, Avionics and Defense	www.ti.com/space-avionics-defense
Video and Imaging	www.ti.com/video

TI E2E Community

e2e.ti.com