

1.5A ULTRA LOW DROPOUT LINEAR REGULATOR**AZ39151****General Description**

The AZ39151 is a 1.5A, high accuracy linear voltage regulator. It features 375mV dropout voltage at 1.5A output current and low ground current over all operating conditions .

The AZ39151 is specifically designed for low voltage, high current output systems, such as PC add-in cards where their tiny dropout voltage and ground current values are important attributes.

The AZ39151 has 3.3V and 5.0V versions.

The AZ39151 is available in TO-252-4 (PPAK) package.

Features

- Minimum Guaranteed Output Current: 1.5A
- Low Dropout Voltage: 375mV at $I_{OUT}=1.5A$
- Output Accuracy: $\pm 1\%$
- Low Ground Current
- Internal Current and Thermal Limit
- Reversed-battery and Reversed-lead Insertion Protection
- Fast Transient Response
- TTL/CMOS Compatible Enable Pin

Applications

- Set-top Box
- Hi-end DVD Player/Recorder
- LCD TV/PDP
- LDO Linear Regulator for PC Add-in Cards
- High Efficiency Linear Power Supplies
- SMPS Post Regulator

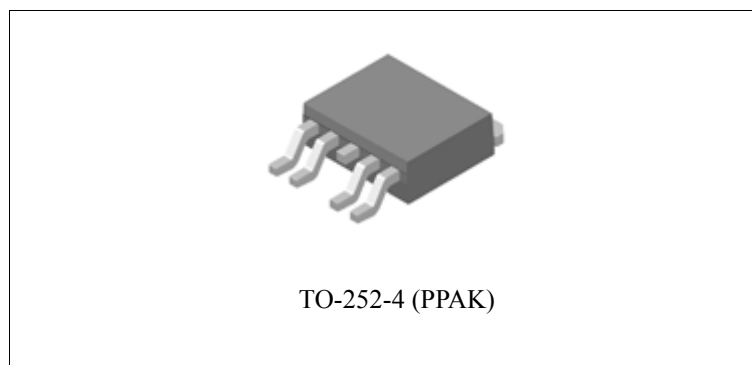

Figure 1. Package Type of AZ39151

1.5A ULTRA LOW DROPOUT LINEAR REGULATOR
AZ39151
Pin Configuration

 D4 Package
 TO-252-4 (PPAK)

Figure 2. Pin Configuration of AZ39151 (Top View)

Pin Description

Pin Number	Pin Name	Function
1	EN	Enable: TTL/CMOS compatible input. Logic high=enable; Logic low or open=shutdown
2	VIN	Unregulated input
3	GND	Ground pin. This pin and TAB are internally connected
4	VOUT	Regulated output
5	NC	No connection

1.5A ULTRA LOW DROPOUT LINEAR REGULATOR **AZ39151**

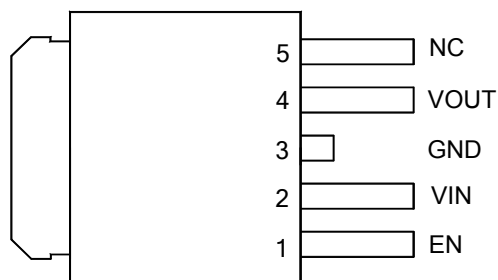
Functional Block Diagram

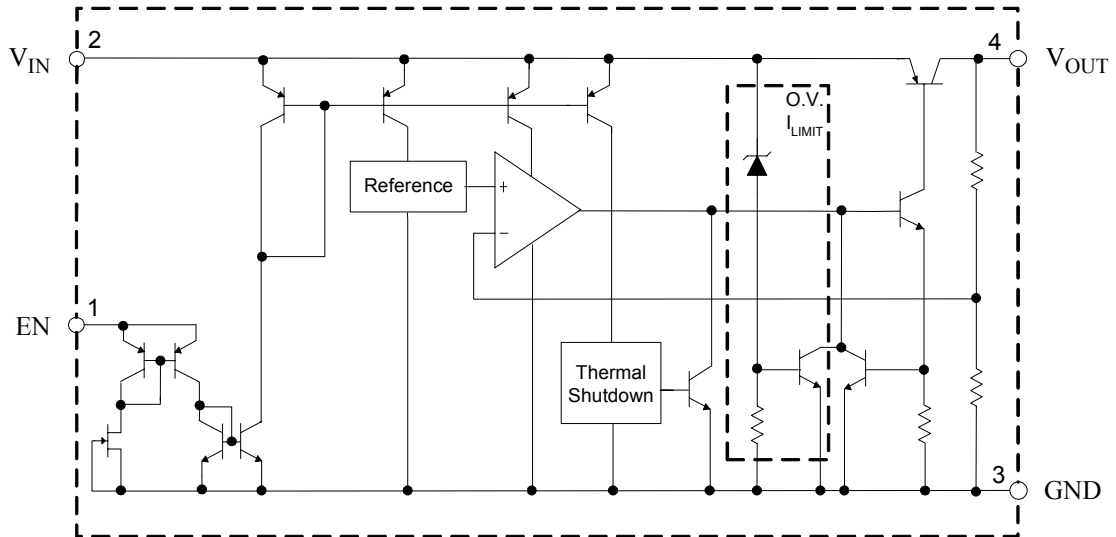

Figure 3. Functional Block Diagram of AZ39151



1.5A ULTRA LOW DROPOUT LINEAR REGULATOR

AZ39151

Ordering Information

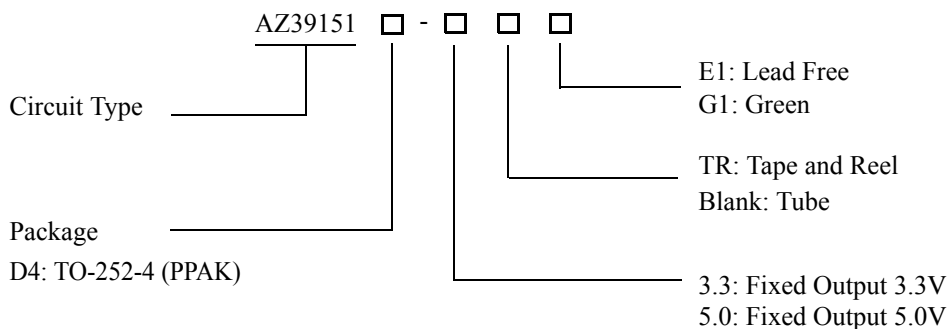

Package	Temperature Range	Part Number		Marking ID		Packing Type
		Lead Free	Green	Lead Free	Green	
TO-252-4 (PPAK)	-40 to 125°C	AZ39151D4-3.3E1	AZ39151D4-3.3G1	AZ39151D4-3.3E1	AZ39151D4-3.3G1	Tube
		AZ39151D4-3.3TRE1	AZ39151D4-3.3TRG1	AZ39151D4-3.3E1	AZ39151D4-3.3G1	Tape & Reel
		AZ39151D4-5.0E1	AZ39151D4-5.0G1	AZ39151D4-5.0E1	AZ39151D4-5.0G1	Tube
		AZ39151D4-5.0TRE1	AZ39151D4-5.0TRG1	AZ39151D4-5.0E1	AZ39151D4-5.0G1	Tape & Reel

BCD Semiconductor's Pb-free products, as designated with "E1" suffix in the part number, are RoHS compliant. Products with "G1" suffix are available in green packages.

**1.5A ULTRA LOW DROPOUT LINEAR REGULATOR****AZ39151****Absolute Maximum Ratings (Note 1)**

Parameter	Symbol	Value		Unit
Input Voltage	V_{IN}	15		V
Enable Voltage	V_{EN}	15		V
Operating Junction Temperature	T_J	150		°C
Storage Temperature Range	T_{STG}	-65 to 150		°C
Lead Temperature (Soldering, 10sec)	T_{LEAD}	260		°C
ESD (Human Body Model)	ESD	5000		V
ESD (Machine Model)	ESD	450		V
Thermal Resistance	θ_{JA}	TO-252-4 (PPAK)	100	°C/W

Note 1: Stresses greater than those listed under "Absolute Maximum Ratings" may cause permanent damage to the device. These are stress ratings only, and functional operation of the device at these or any other conditions beyond those indicated under "Recommended Operating Conditions" is not implied. Exposure to "Absolute Maximum Ratings" for extended periods may affect device reliability.

Recommended Operating Conditions

Parameter	Symbol	Min	Max	Unit
Input Voltage	V_{IN}		13.5	V
Enable Voltage	V_{EN}		13.5	V
Operating Junction Temperature	T_J	-40	125	°C



1.5A ULTRA LOW DROPOUT LINEAR REGULATOR AZ39151

Electrical Characteristics

Operating Conditions: $V_{IN}=V_{OUT}+1V$, $I_{OUT}=10mA$, $C_{IN}=10\mu F$, $C_{OUT}=10\mu F$, $T_J=25^{\circ}C$, unless otherwise specified. The **Bold-face** applies over $-40^{\circ}C \leq T_J \leq 125^{\circ}C$.

Parameter	Symbol	Conditions	Min	Typ	Max	Unit	
Output Voltage	V_{OUT}		-1		1	%	
		$10mA \leq I_{OUT} \leq 1.5A$, $V_{OUT}+1V \leq V_{IN} \leq 13.5V$	-2		2		
Line Regulation	V_{RLINE}	$V_{OUT}+1V \leq V_{IN} \leq 13.5V$		3	25	mV	
Load Regulation	V_{RLOAD}	$10mA \leq I_{OUT} \leq 1.5A$		10	50	mV	
Output Voltage Temperature Coefficient (Note 2)	$\Delta V_{OUT}/\Delta T$ $(\Delta V_{OUT}/V_{OUT})/\Delta T$			100	500	$\mu V/^{\circ}C$	
				20	100	ppm/ $^{\circ}C$	
Dropout Voltage (Note 3)	V_{DROP}	$\Delta V_{OUT}=1\%$	$I_{OUT}=100mA$		80	200	mV
			$I_{OUT}=750mA$		260		mV
			$I_{OUT}=1.5A$		375	700	mV
Ground Current	I_{GND}	$I_{OUT}=750mA$		5	10	mA	
		$I_{OUT}=1.5A$		17	34	mA	
Standby Current	I_{STD}	$V_{IN}=13.5V$, $V_{EN}=0V$		130	220	μA	
Dropout Ground Pin Current	$I_{GND(DO)}$	$V_{IN} \leq V_{OUT(NOMINAL)} - 0.5V$		5		mA	
Short Circuit Current	I_{SHORT}	$V_{OUT}=0V$		2.8		A	
Output Noise Voltage (rms)		10Hz to 100kHz, $I_{OUT}=100mA$		200		μV	
Minimum Load Current	$I_{LOAD(MIN)}$				5	mA	
Power Supply Ripple Rejection	PSRR	$f=120Hz$, $I_{OUT}=750mA$	49	65		dB	
Enable Input							
Enable Voltage	V_{EN}	Logic low (off)			0.8	V	
		Logic high (on)	2.25				
Enable Current	I_{EN}	$V_{EN}=V_{IN}$		15	35	μA	
		$V_{EN}=0.8V$			4		
Shutdown Output Current	$I_{OUT(SHDN)}$	$V_{EN} \leq 0.8V$, $V_{OUT}=0V$, $V_{IN} \leq 8V$		5	10	μA	

Note 2: Output voltage temperature coefficient is defined as the worst case voltage change divided by the total temperature range.

Note 3: Dropout voltage is defined as the input-to-output differential when the output voltage drops to 99% of its nominal value which is measured at $V_{OUT}+1V$ applied to V_{IN} .



1.5A ULTRA LOW DROPOUT LINEAR REGULATOR

AZ39151

Typical Performance Characteristics

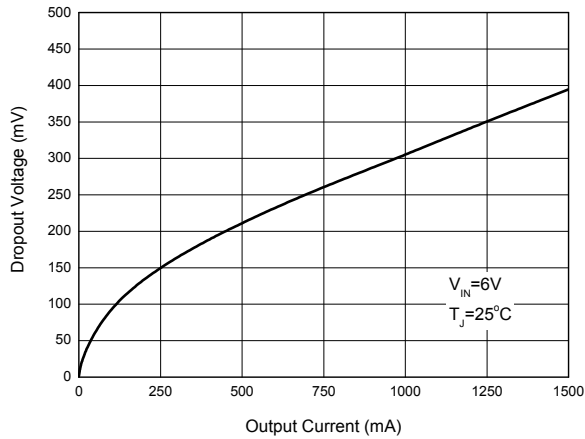

Figure 4. Dropout Voltage vs. Output Current

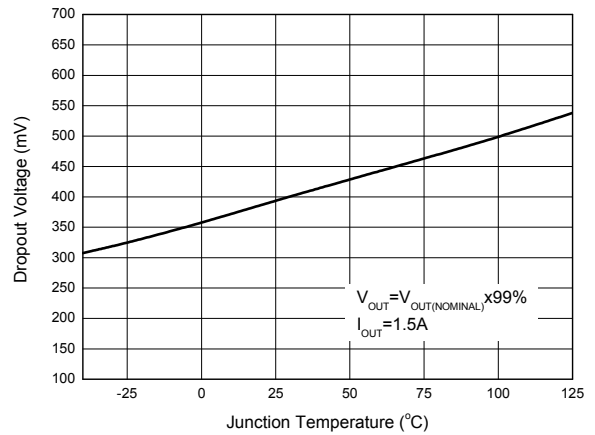

Figure 5. Dropout Voltage vs. Junction Temperature

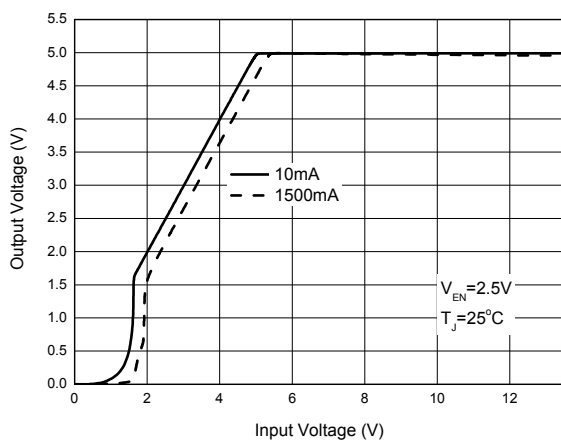

Figure 6. Output Voltage vs. Input Voltage

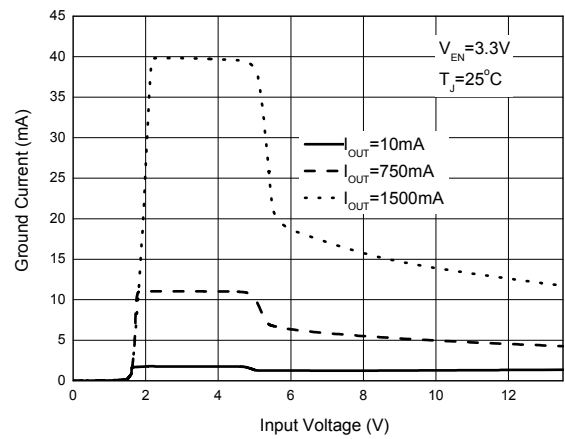

Figure 7. Ground Current vs. Input Voltage



1.5A ULTRA LOW DROPOUT LINEAR REGULATOR

AZ39151

Typical Performance Characteristics (Continued)

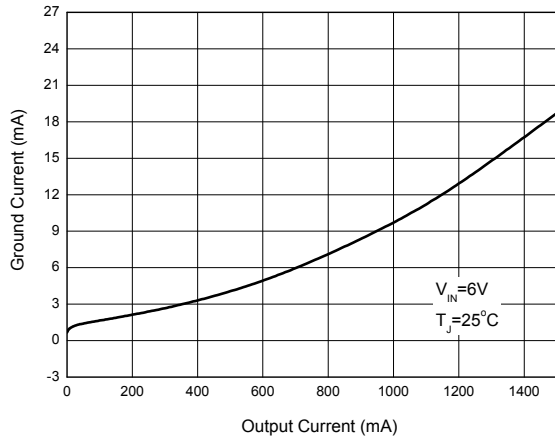

Figure 8. Ground Current vs. Output Current

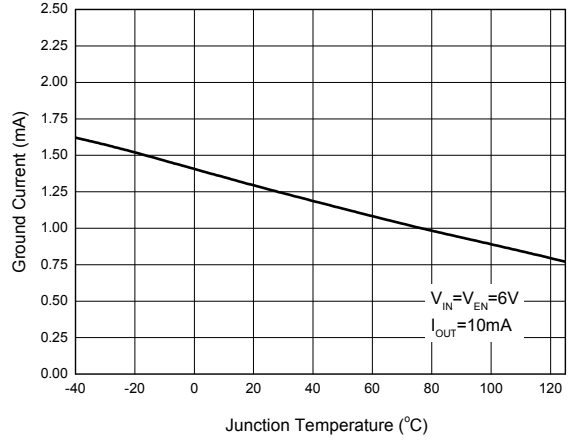

Figure 9. Ground Current vs. Junction Temperature

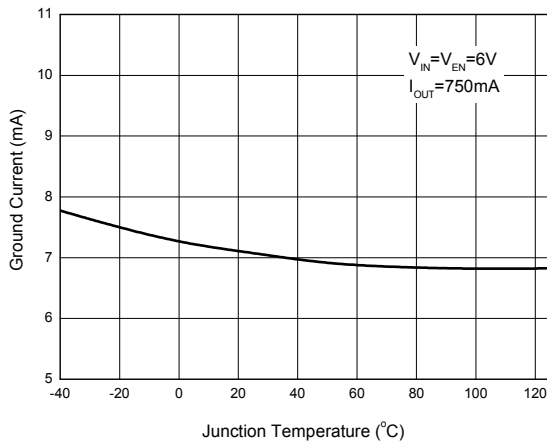

Figure 10. Ground Current vs. Junction Temperature

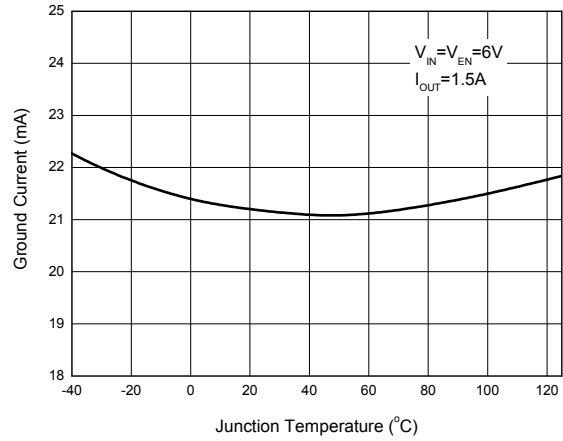

Figure 11. Ground Current vs. Junction Temperature



1.5A ULTRA LOW DROPOUT LINEAR REGULATOR

AZ39151

Typical Performance Characteristics (Continued)

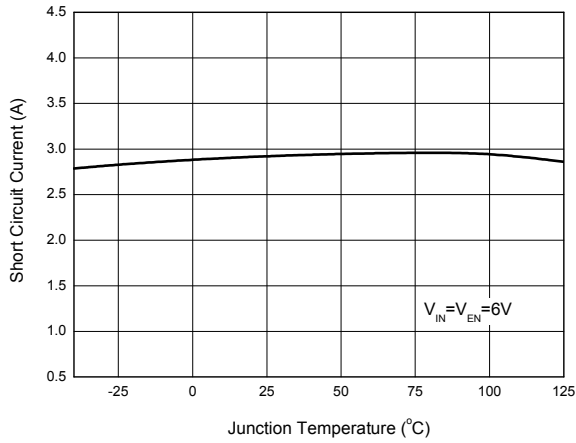

Figure 12. Short Circuit Current vs. Junction Temperature

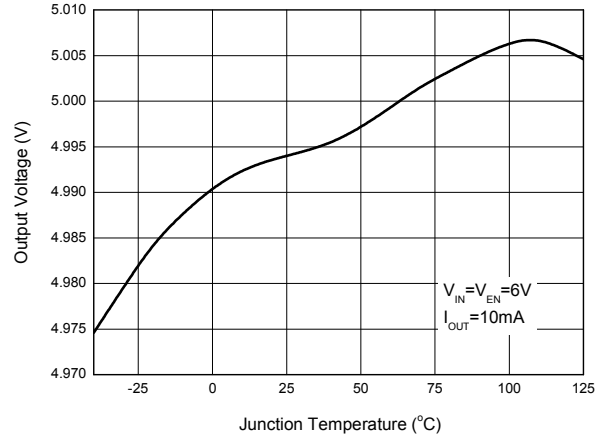

Figure 13. Output Voltage vs. Junction Temperature

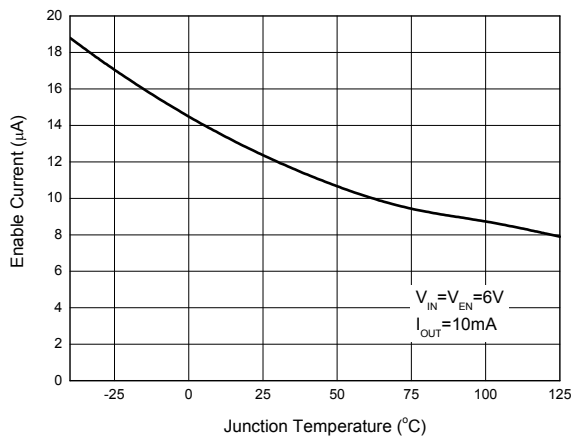

Figure 14. Enable Current vs. Junction Temperature

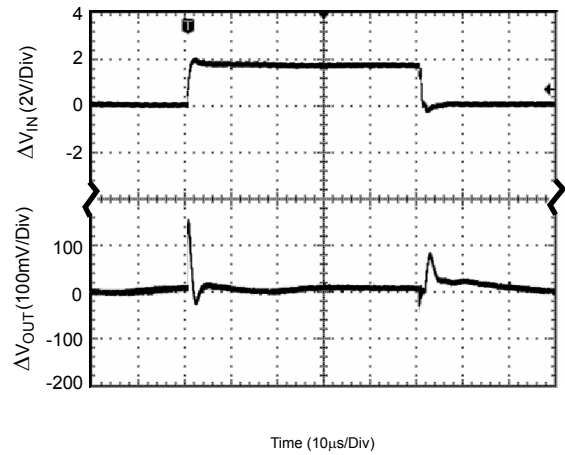

Figure 15. Line Transient
(Conditions: $V_{IN}=5$ to $7V$, $I_{OUT}=1.5A$, $C_{OUT}=10\mu F$)



1.5A ULTRA LOW DROPOUT LINEAR REGULATOR

AZ39151

Typical Performance Characteristics (Continued)

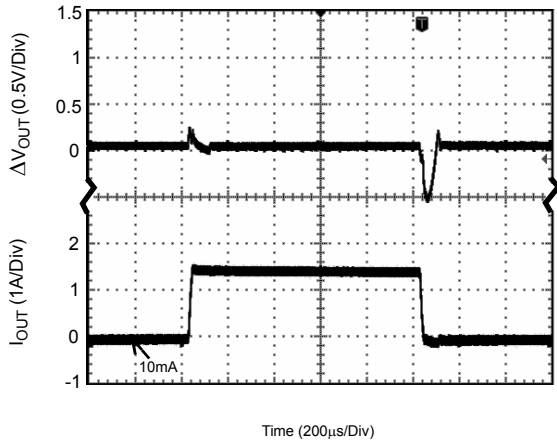

Figure 16. Load Transient

(Conditions: $V_{IN}=6V$, $I_{OUT}=10mA$ to $1.5A$, $C_{IN}=C_{OUT}=10\mu F$)

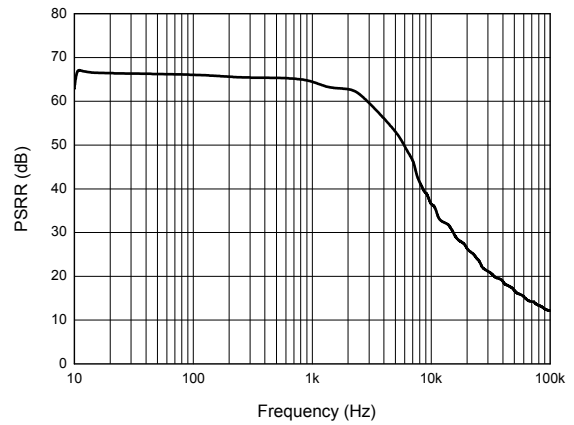

Figure 17. PSRR vs. Frequency

(Conditions: $V_{IN}=6V$, $I_{OUT}=10mA$, $C_{IN}=C_{OUT}=10\mu F$)

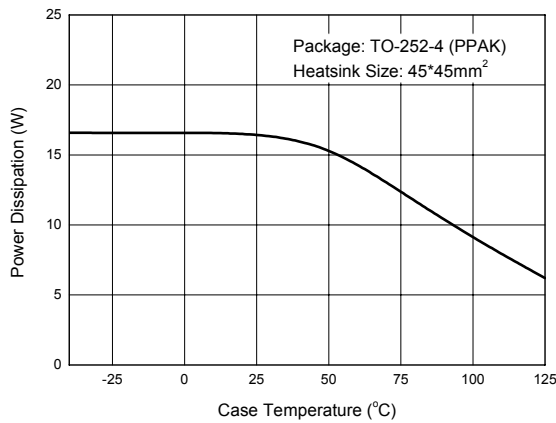

Figure 18. Power Dissipation vs. Case Temperature

1.5A ULTRA LOW DROPOUT LINEAR REGULATOR **AZ39151**

Typical Application

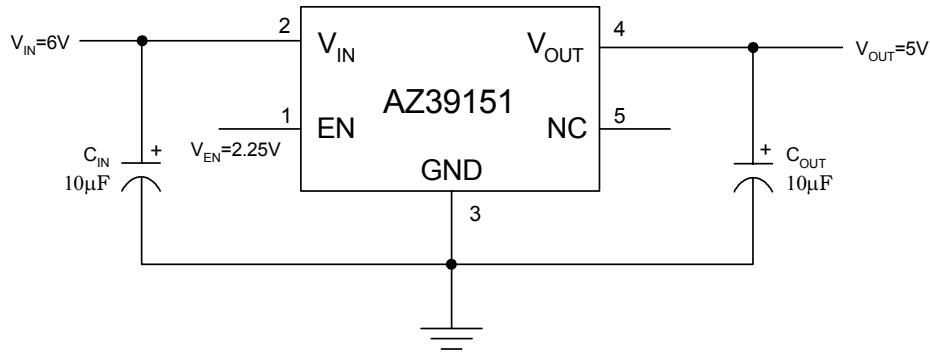

Figure 19. Typical Application of AZ39151



1.5A ULTRA LOW DROPOUT LINEAR REGULATOR **AZ39151**

Mechanical Dimensions

TO-252-4 (PPAK)

Unit: mm(inch)

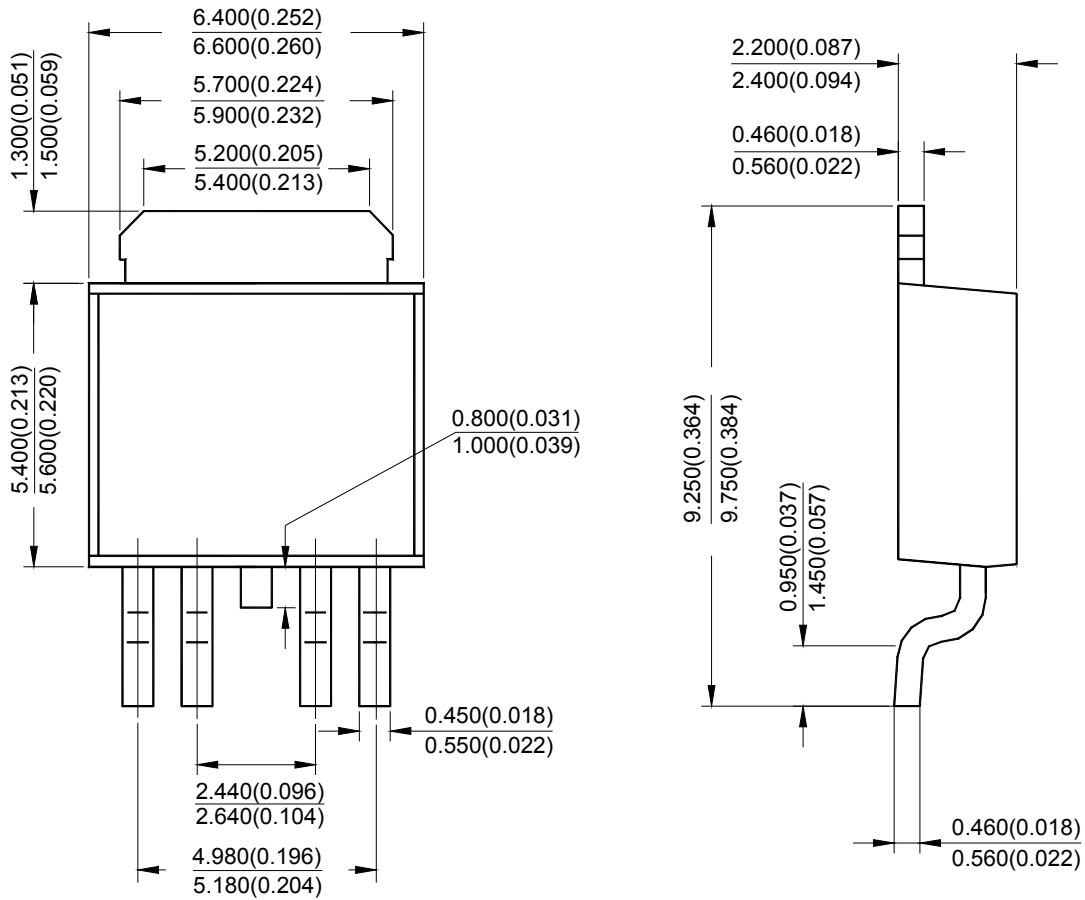



BCD Semiconductor Manufacturing Limited

<http://www.bcdsemi.com>

IMPORTANT NOTICE

BCD Semiconductor Manufacturing Limited reserves the right to make changes without further notice to any products or specifications herein. BCD Semiconductor Manufacturing Limited does not assume any responsibility for use of any its products for any particular purpose, nor does BCD Semiconductor Manufacturing Limited assume any liability arising out of the application or use of any its products or circuits. BCD Semiconductor Manufacturing Limited does not convey any license under its patent rights or other rights nor the rights of others.

MAIN SITE

- Headquarters

BCD Semiconductor Manufacturing Limited

No. 1600, Zi Xing Road, Shanghai ZiZhu Science-based Industrial Park, 200241, China
Tel: +86-21-24162266, Fax: +86-21-24162277

- Wafer Fab

Shanghai SIM-BCD Semiconductor Manufacturing Co., Ltd.

800 Yi Shan Road, Shanghai 200233, China
Tel: +86-21-6485 1491, Fax: +86-21-5450 0008

REGIONAL SALES OFFICE

Shenzhen Office

Shanghai SIM-BCD Semiconductor Manufacturing Co., Ltd., Shenzhen Office

Unit A Room 1203, Skyworth Bldg., Gaoxin Ave. 1.S., Nanshan District, Shenzhen, China
Tel: +86-755-8826 7951
Fax: +86-755-8826 7865

Taiwan Office

BCD Semiconductor (Taiwan) Company Limited

4F, 298-1, Rui Guang Road, Nei-Hu District, Taipei, Taiwan
Tel: +886-2-2656 2808
Fax: +886-2-2656 2806

USA Office

BCD Semiconductor Corp.

30920 Huntwood Ave. Hayward, CA 94544, USA
Tel : +1-510-324-2988
Fax: +1-510-324-2788