

# SPECIFICATION FOR APPROVAL

## 規 格 書

Customer (客戶名稱): \_\_\_\_\_

Customer P/N(客戶番號): \_\_\_\_\_

Our P/N (本廠番號): FS7423NB0430-H10.0

Approval Date(日期): 2020.4.29

Environment Request(環境標準):

Non-RoHS (非 RoHS 標準)

RoHS2.0 (RoHS2.0 標準)

REACH (REACH 標準)

Others (其他)

CUSTOMER'S APPROVED SIGNATURE

泰州福聲電子科技有限公司



Taizhou Fusheng Electronic Technology Co.,Ltd.

Adds: No168 of FengHuang Road West,Hailing District ,Taizhou .

地址: 江蘇省泰州市海陵區鳳凰西路168號

Tel: +86-523-86219066

Fax: +86-523- 81601108

[Http://www.tzfsdz.com](http://www.tzfsdz.com)

E-mail: [sales@electronic-tech.cn](mailto:sales@electronic-tech.cn)

	DESINGER	CHECKED	APPROVED
SIGNATURE			
DATE			



## Speaker Specification

Part No.	Customer No 顧客型號		Customer code 顧客編號	
	Our Part No 本廠編號	FS7423NS0430-H10.0		Revision 版本 A
No.	Item 項目	Specification 規格	Testing Condition 測試條件	
1.	Rated Imp 共稱阻抗	4Ω±15%	At 1kHz 1.0Vrms	
2.	Resonance Freq 最低共振周波數	Fb: 500Hz±20% Fo: 1200Hz±20%	Without Baffle	
3.	Output S.P.L. 出力音壓	90±3dB	At 0.1m 0.1w 1.0,1.5,2.0,3.0KHz Average	
4.	Rated Power 定格入力	at 3.0W	at 3.47 Vrms	
5.	Max Power 最大入力	at 3.5W	at 3.74Vrms	
6.	Frequency Range 實效頻寬	FO----20kHz		
7.	Operation 可靠性試驗	Must Be Normal at Rated Frequency Range	ProgramSource3.0W FO~10kHz	
8.	Buzzes & Rattles 異常音試驗	Should not be audible buzz and rattle at Rated Frequency Range 無異常聲	Sine Wave Between (正弦波入力) at 3.47 Vrms / FO---- 10kHz	
9.	T H D 失真	10% Max	Rated Power Input 1000Hz	
10.	Magnet 磁鐵	NdFeB		
11.	Operating Temperature 動作溫度	-20°C to +50°C		
12.	Storage Temperature 儲存溫度	-30°C to +60°C		
13.	Weight 重量	g		

14.	Cold Test 耐寒試驗	Must be normal after having been in a test chamber for 96 hours at the condition of $-20^{\circ}\text{C} \pm 2^{\circ}\text{C}$ and then left 2 hours in a room. ( $-20^{\circ}\text{C} \pm 2^{\circ}\text{C}$ , 96 小時試驗室溫兩小時後, 無異常)
15.	Heat Test 耐熱試驗	Must be normal after having been in a test chamber for 96 hours at the condition of $+50^{\circ}\text{C} \pm 2^{\circ}\text{C}$ 90~95% R.H and then left 2 hours in a room. ( $+50^{\circ}\text{C} \pm 2^{\circ}\text{C}$ 90~95% R.H 96 小時試驗常溫 2 小時後, 無異常的不良)
16.	Load Test 連續負荷試驗	Must be normal after load test :White noise 3W 96 hours. At rated frequency range (白噪音3.0W 連續 96 小時試驗後無異常的不良)
17	Short Term Maximum Power test 瞬間最大功率測試	Test for 1 hour under maximum power. Input shall be White noise in rated frequency response. And the signal will be 1 second on, 59 seconds off, total 60 cycles at rated frequency range, Must be normal after the test (白噪音3.5W, 1 秒開 59 秒關, 連續 60 迴圈, 試驗後無異常之不良)
18.	-Polarity 極性	When a DC source 's "+" polarity is attached to speaker's "+" polarity, "-" polarity is attached speaker's "-" polarity, the membrane will move forward. Red wire is "+" and the black wire is "-". (接線板由側為正極, 左側為負極)
19.	Drop Test 跌落試驗	Drop the speakers contained in normal box onto a board 5mm thick 6 times from a height of 1.0m . Must be normal after the test (在厚 5mm 的木板上從 1.0m 的高度跌落 6 次, 無異常不良)

### Temperature Cycle Test(5 cycle)

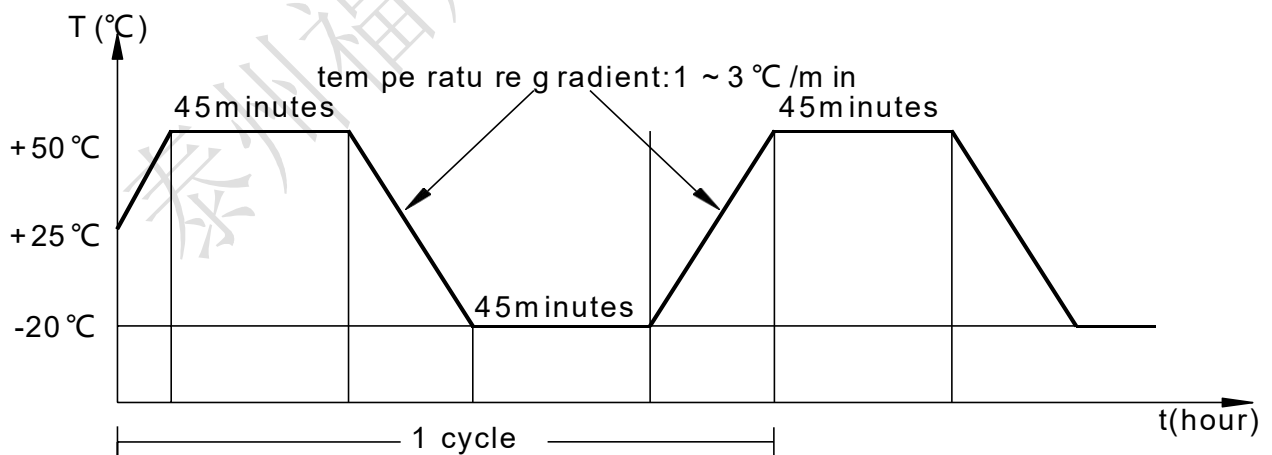

# Frequency Response

## 频响曲线

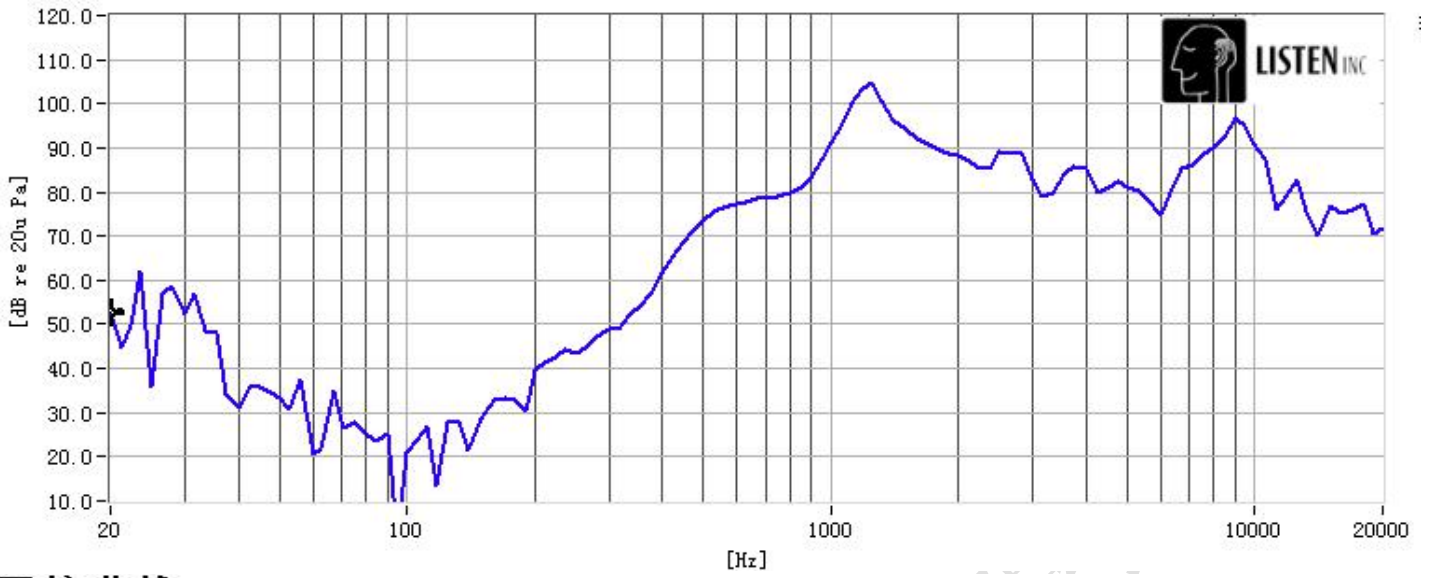

## 阻抗曲线

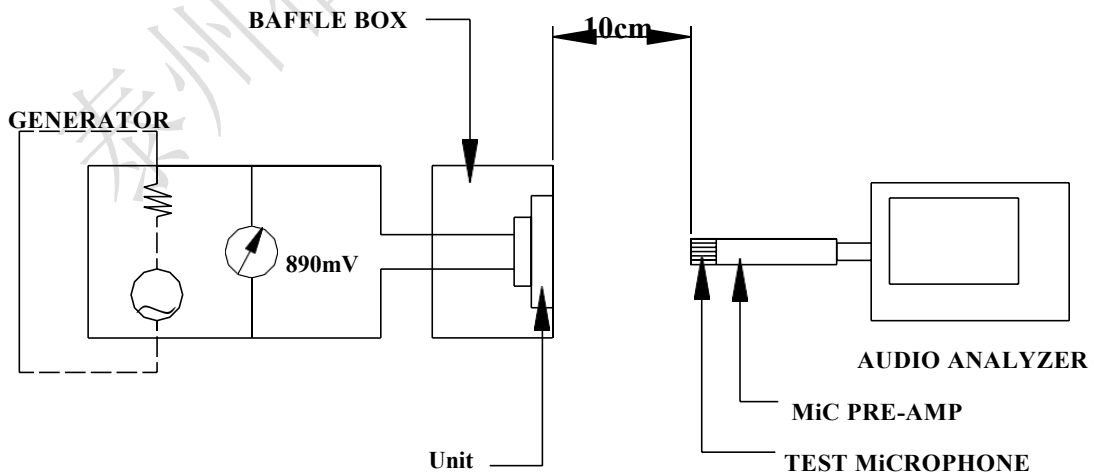
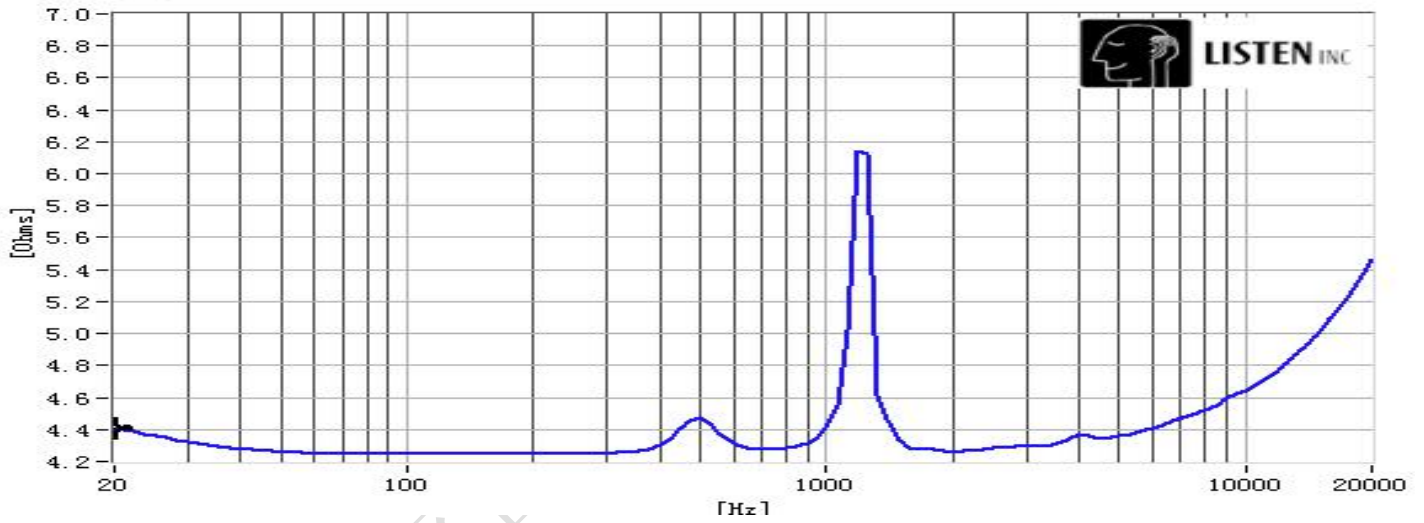

Product Outside View

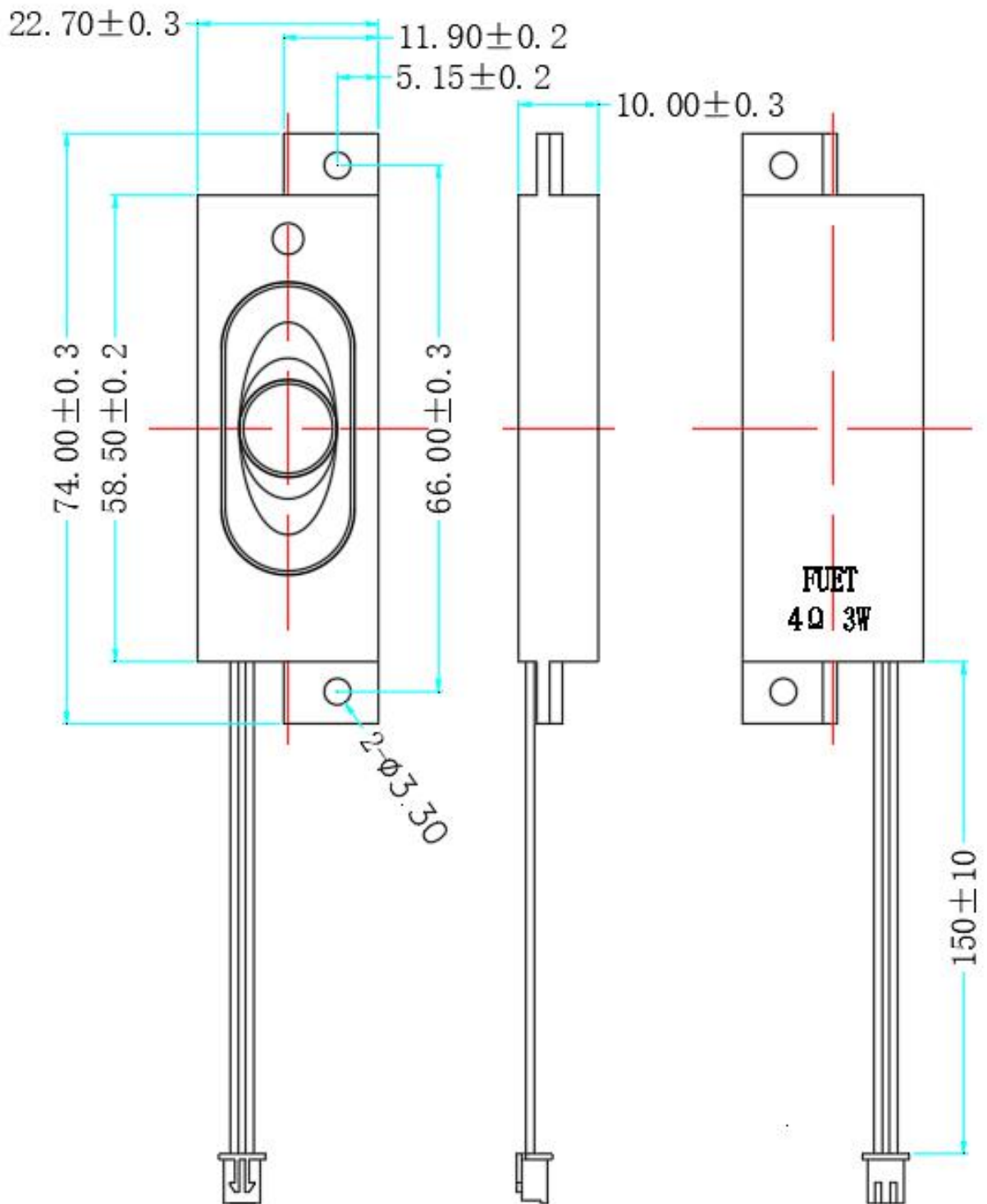

线长300mm 2P 2.0端子