

WL2836E

Low noise, High PSRR, High speed, CMOS LDO

Descriptions

The WL2836E series is a high accuracy, low noise, high speed, high PSRR, low dropout CMOS Linear regulator with high ripple rejection. The devices offer a new level of cost effective performance in cellular phones, laptop and notebook computers, and other portable devices.

The WL2836E has the fold-back maximum output current which depends on the output voltage. So the current limit functions both as a short circuit protection and as an output current limiter.

The WL2836E regulators are available in standard SOT-23-5L Package. Standard products are Pb-free and Halogen-free.

Features

- Input Voltage Range : 1.4V~5.5V
- Output Voltage Range : 0.8V~3.3V
- Output current : 300mA
- Quiescent current : 50μA Typ.
- Shut-down current : < 1μA
- Dropout voltage : 140mV @ I_{OUT}=0.3A
- PSRR : 78dB @ 1kHz, V_{OUT}=1.8V
- Low Output Voltage Noise : 20μV_{RMS} Typ.
- Output Voltage Tolerance : ±2% @ V_{OUT}>2V
- Recommend capacitor : 1μF
- Thermal-Overload and Short-Circuit Protection

Applications

- MP3/MP4 Players
- Cellphones, radiophone, digital cameras
- Bluetooth, wireless handsets
- Others portable electronics device

<https://www.omnivision-group.com/>



SOT-23-5L

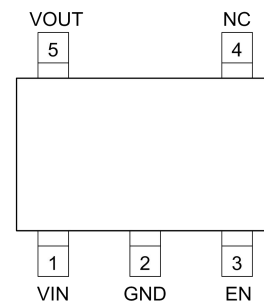

SOT-23-5L

Pin Configuration (Top View)

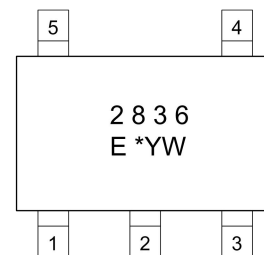

SOT-23-5L

2836 : Device Code

E : Package Code

* : Voltage Code

Y : Year code

W: Week code

For detail marking information, please see page 15.

Marking

Order information

For detail order information, please see page 15.

Typical Application

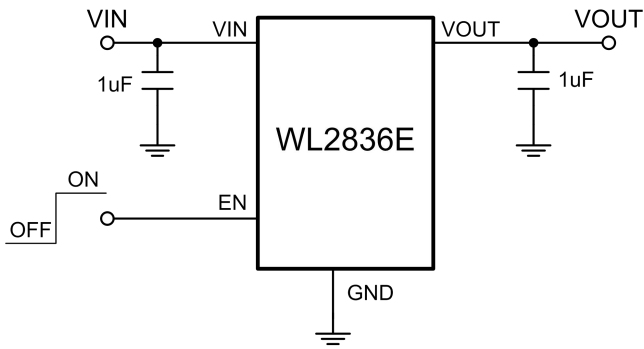

Pin Description

SOT-23-5L

PIN	Symbol	Description
1	V _{IN}	Input
2	GND	Ground
3	EN	Enable (Active high)
4	NC	No connection
5	V _{OUT}	Output

Block Diagram

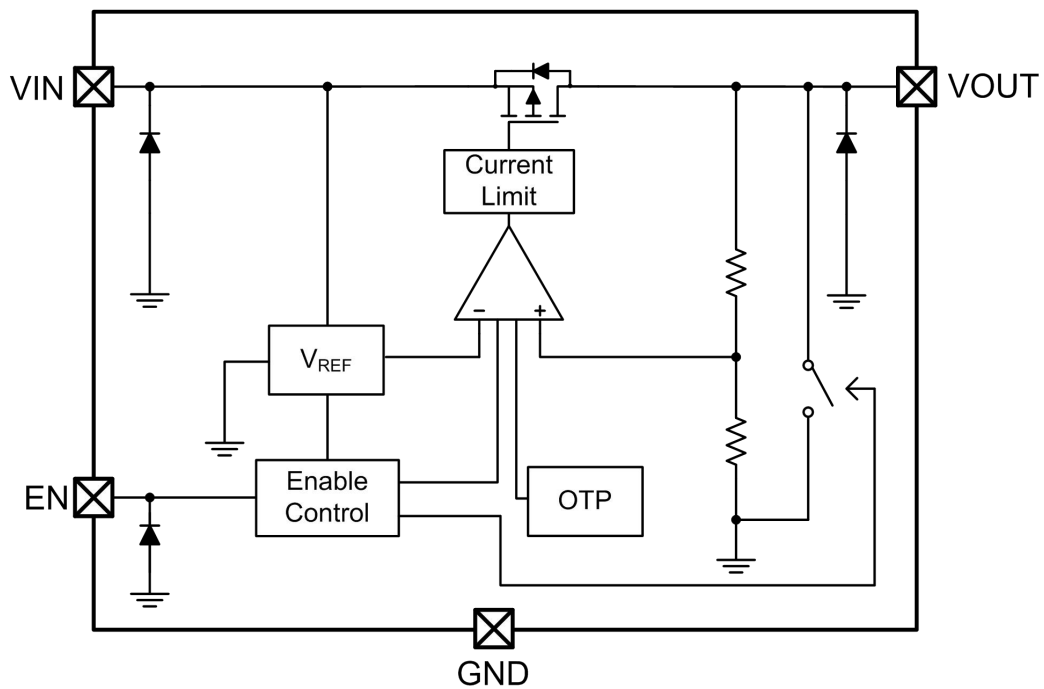

Absolute Maximum Ratings

Parameter	Value	Unit	
Power Dissipation, $P_D@T_A=25^{\circ}\text{C}$	400	mW	
V_{IN} Range	-0.3~6.5	V	
V_{EN} Range	-0.3~ V_{IN}	V	
V_{OUT} Range	-0.3~ V_{IN}	V	
I_{OUT}	400	mA	
Lead Temperature Range	260	$^{\circ}\text{C}$	
Storage Temperature Range	-55 ~ 150	$^{\circ}\text{C}$	
Operating Junction Temperature Range	150	$^{\circ}\text{C}$	
MSL	Level-3		
ESD Ratings	HBM	7500	V
	MM	300	V

Recommend Operating Ratings

Parameter	Value	Unit
Operating Supply voltage	1.4~5.5	V
Operating Temperature Range	-40~85	$^{\circ}\text{C}$
Thermal Resistance, $R_{\theta JA}$ (SOT-23-5L)	250	$^{\circ}\text{C}/\text{W}$

Electronics Characteristics

 (Ta=25°C, V_{IN}=V_{OUT}+1V, C_{IN}=C_{OUT}=1 μ F, I_{OUT}=1mA, unless otherwise noted)

Parameter	Symbol	Condition	Min.	Typ.	Max.	Unit	
Output Voltage	V _{OUT}	V _{OUT} ≤ 2V	-30	V _{OUT}	+30	mV	
		V _{OUT} > 2V	0.98× V _{OUT}	V _{OUT}	1.02× V _{OUT}	V	
Input Voltage	V _{IN}		1.4		5.5	V	
Current Limit	I _{LIM}	V _{EN} =V _{IN}	300			mA	
Dropout Voltage	V _{DROP}	V _{OUT} =3.3V, I _{OUT} =300mA		118	185	mV	
		V _{OUT} =3V, I _{OUT} =300mA		122	192		
		V _{OUT} =2.8V, I _{OUT} =300mA		130	204		
		V _{OUT} =2.5V, I _{OUT} =300mA		140	220		
		V _{OUT} =1.6V, I _{OUT} =300mA		205	320		
		V _{OUT} =1V, I _{OUT} =300mA		370	555		
Line Regulation	ΔV _{LINE}	V _{IN} =V _{OUT} +0.5V~5.5V		1	5	mV	
Load Regulation	ΔV _{Load}	V _{OUT} =2.8V, I _{OUT} =1~300mA		22	40	mV	
Quiescent Current	I _Q	V _{OUT} =2.8V, I _{OUT} =0		50	90	μA	
Short Current	I _{SHORT}	V _{EN} =V _{IN} , V _{OUT} Short to GND with 1 Ω		120		mA	
Shut-down Current	I _{SHDN}	V _{EN} =0V			1.0	μA	
Power Supply Rejection Rate	PSRR	V _{IN} =(V _{OUT} +1V) _{DC} + 0.5V _{P-P} I _{OUT} =10mA, V _{OSET} =1.8V	f=100Hz		80		dB
			f=1kHz		78		dB
			f=10kHz		65		dB
			f=100kHz		56		dB
			f=1MHz		43		dB
EN logic high voltage	V _{ENH}	V _{IN} =5.5V, I _{OUT} =1mA	1			V	
EN logic low voltage	V _{ENL}	V _{IN} =5.5V, V _{OUT} =0V			0.4	V	
EN Input Current	I _{EN}	V _{EN} = 0 to 5.5V		120		nA	
Output Noise Voltage	e _{NO}	10Hz to 100KHz, C _{OUT} =1μF		13× V _{OUT}		μV _{RMS}	
Thermal shutdown threshold	T _{SD}			160		°C	
Thermal shutdown hysteresis	Δ T _{SD}			30		°C	
Auto-discharge Nch Tr, ON Resistance	R _{LOW}	V _{IN} =4V, V _{CE} =0V, V _{OUT} =2.8V		120		Ω	

Typical characteristics (Ta=25°C, VIN=VOUT+1V, IOUT=1mA, CIN=COUT=1 μ F, unless otherwise noted)

(1) EN is driven by square pulse, the duty cycle is less than 20%

VOUT=0.9V

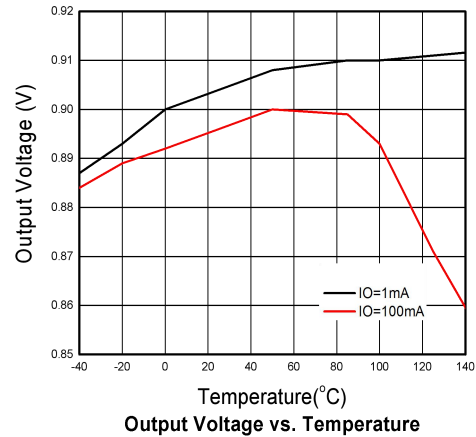
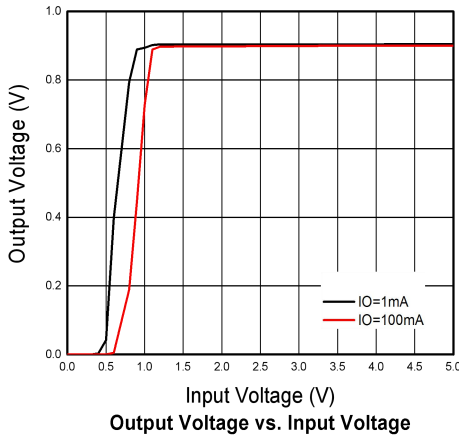

VOUT=1.2V

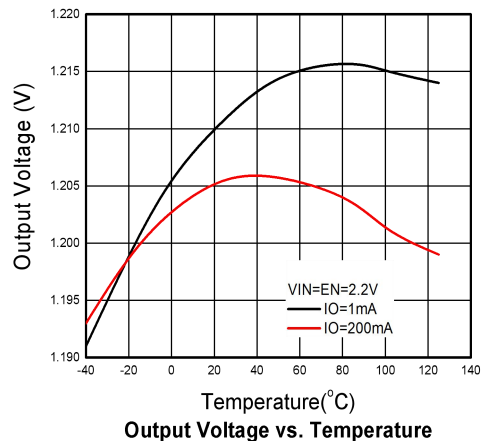
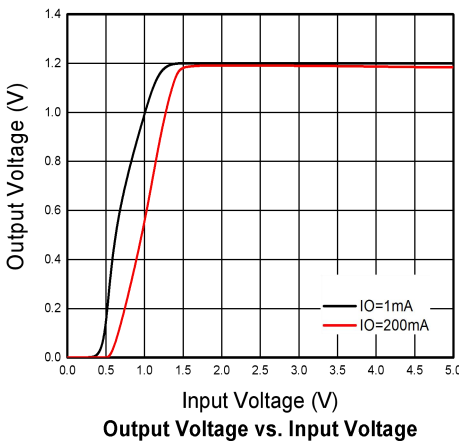

VOUT=1.8V

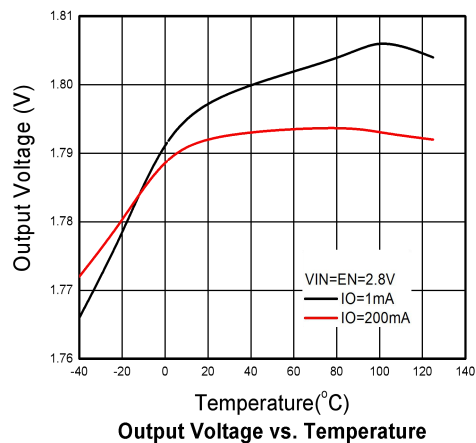
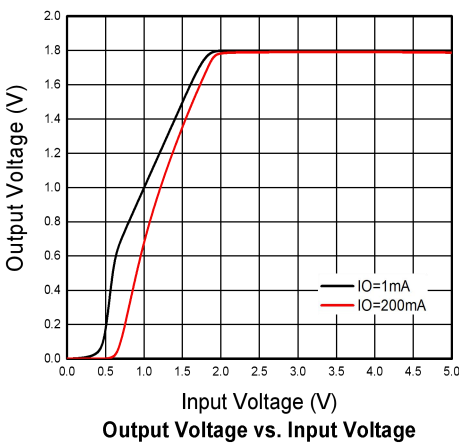

V_{OUT}=2.8V

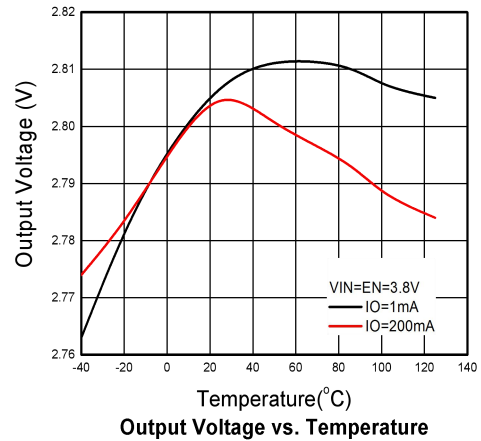
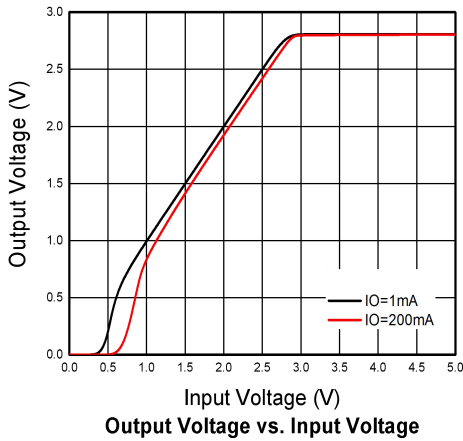

V_{OUT}=1.8V

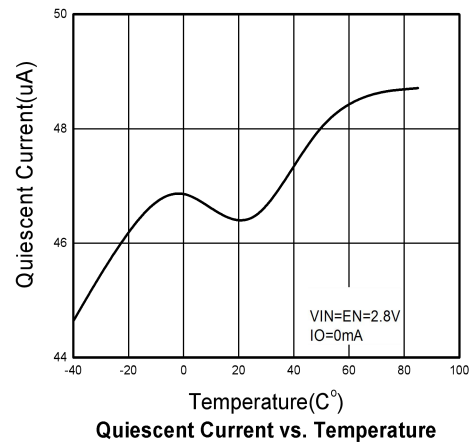
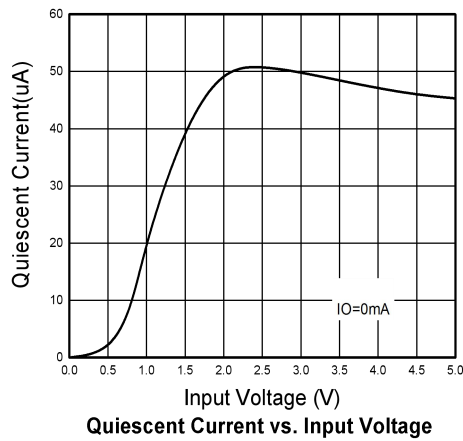

V_{OUT}=1.8V

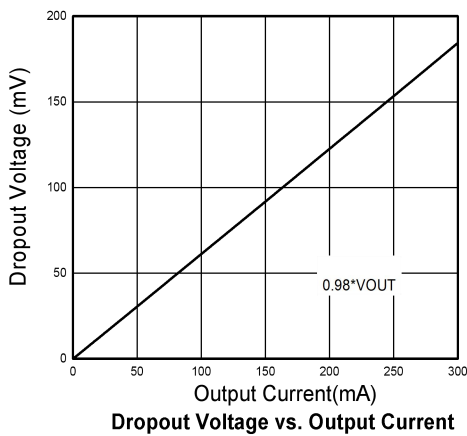

V_{OUT}=2.8V

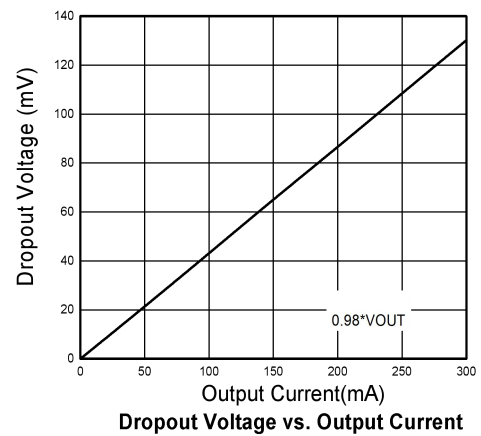

V_{OUT}=3.0V

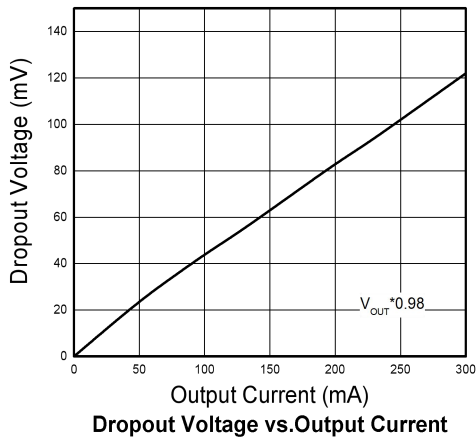

V_{OUT}=3.3V

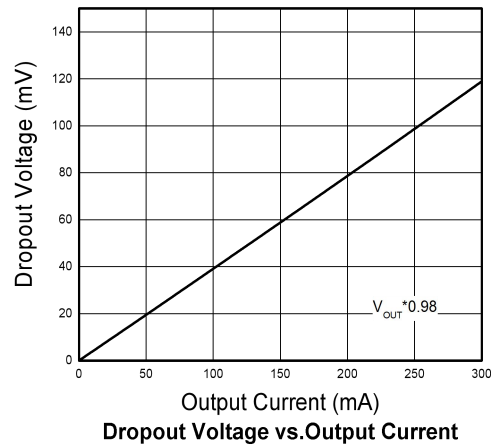

V_{out}=0.9V⁽¹⁾

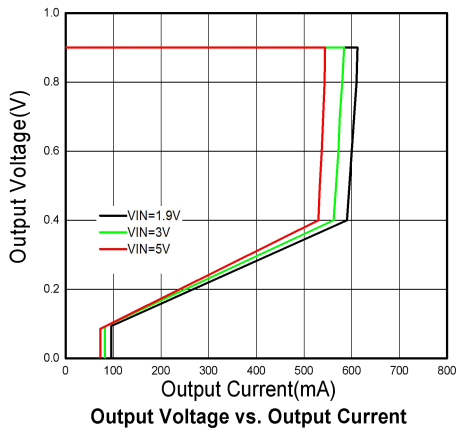

V_{out}=1.2V⁽¹⁾

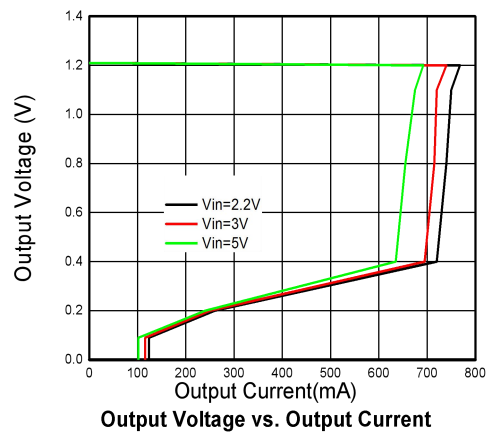

V_{out}=1.8V⁽¹⁾

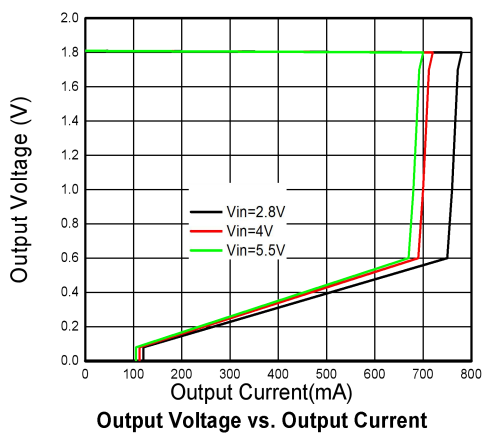

V_{out}=2.8V⁽¹⁾

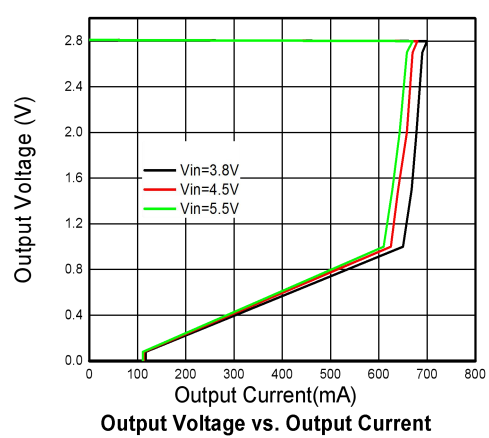

V_{OUT}=0.9V

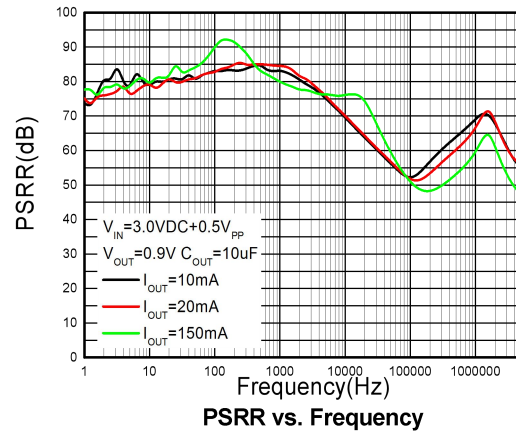
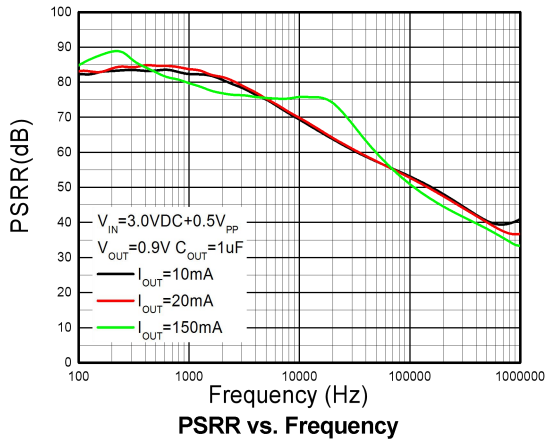

V_{OUT}=1.8V

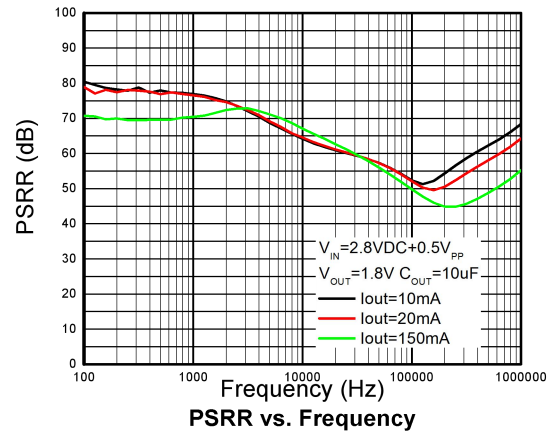
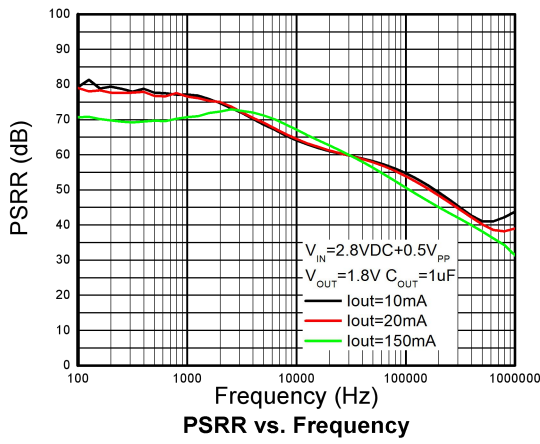

V_{OUT}=2.8V

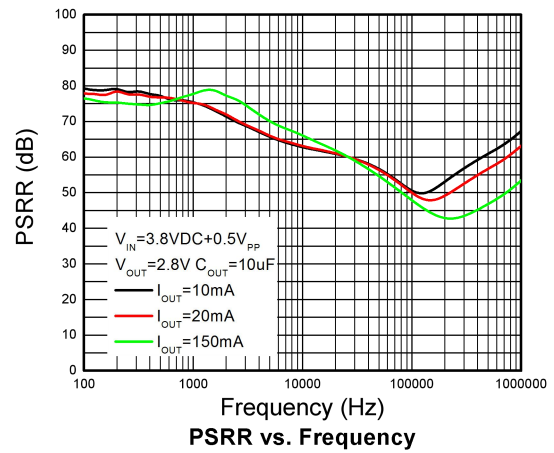
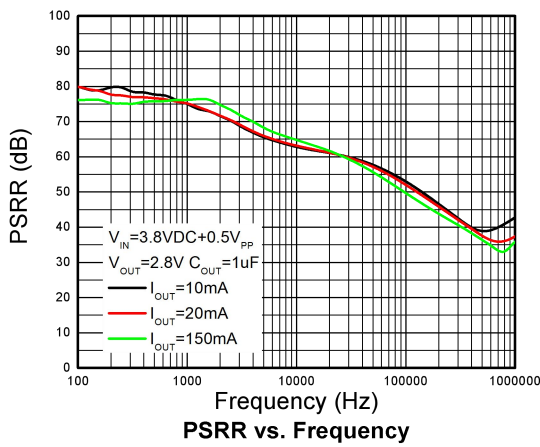

1.Start up (Soft Start from EN)

Vout=0.9V

V_{IN}=1.9V,C_{OUT}=1μF,I_{OUT}=10mA

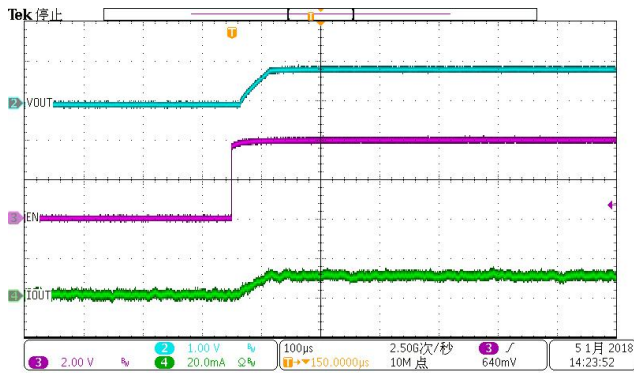

V_{IN}=1.9V,C_{OUT}=1μF,I_{OUT}=300mA

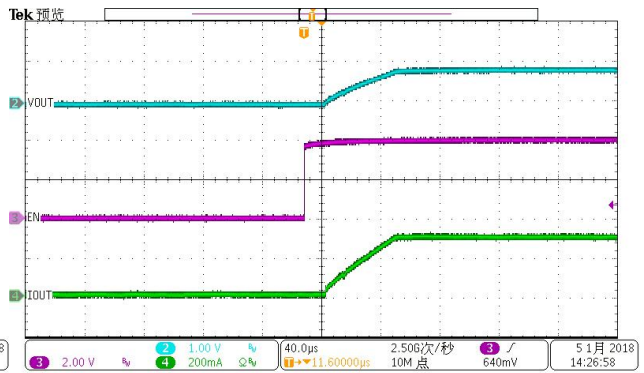

Vout=1.2V

V_{IN}=2.2V,C_{OUT}=1μF,I_{OUT}=10mA

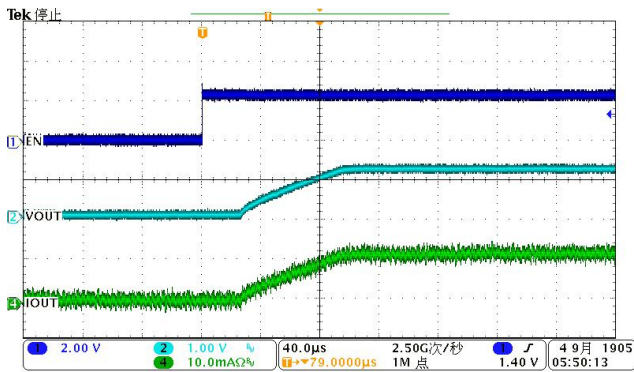

V_{IN}=2.2V,C_{OUT}=1μF,I_{OUT}=300mA

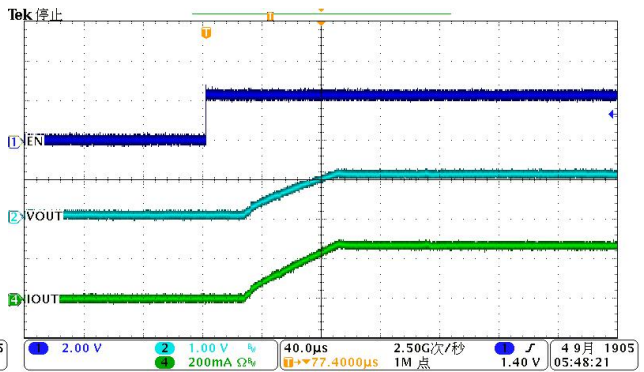

Vout=1.8V

V_{IN}=2.8V,C_{OUT}=1μF,I_{OUT}=10mA

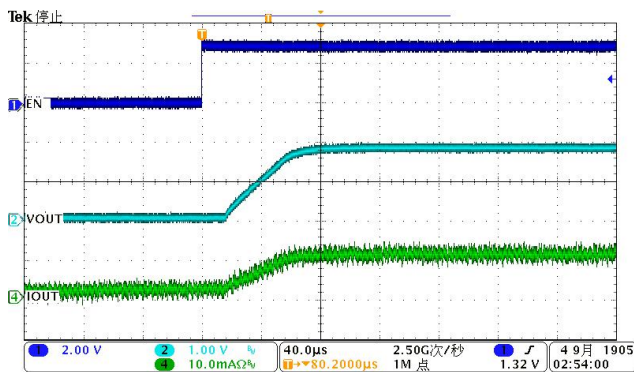

V_{IN}=2.8V,C_{OUT}=1μF,I_{OUT}=300mA

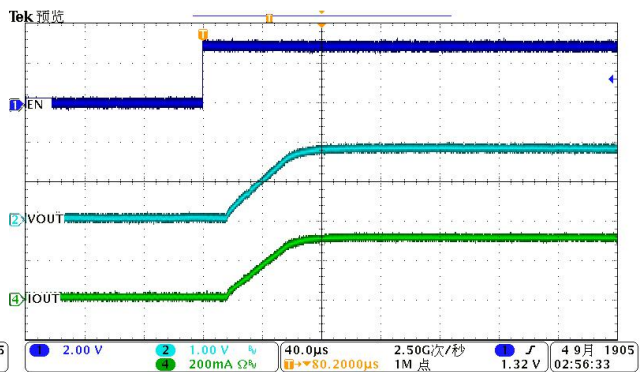

V_{OUT}=2.8V

V_{IN}=3.8V, C_{OUT}=1μF, I_{OUT}=10mA

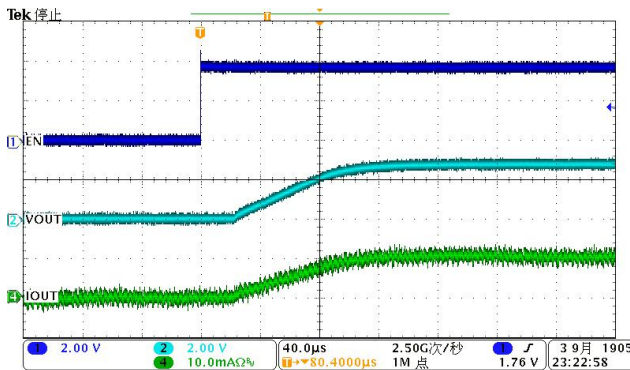

V_{IN}=3.8V, C_{OUT}=1μF, I_{OUT}=300mA

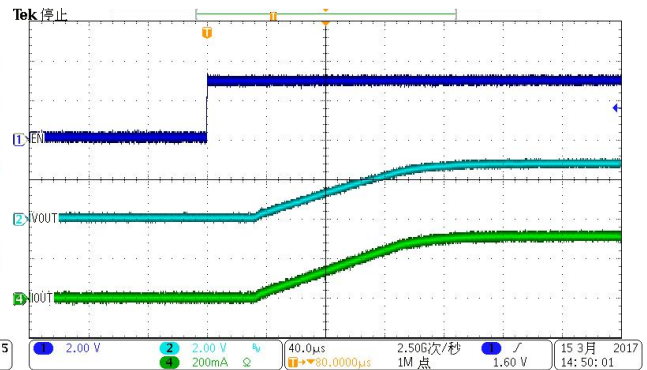

2.Shutdown (Shutdown from EN)

V_{OUT}=0.9V

V_{IN}=1.9V, C_{OUT}=1μF, I_{OUT}=10mA

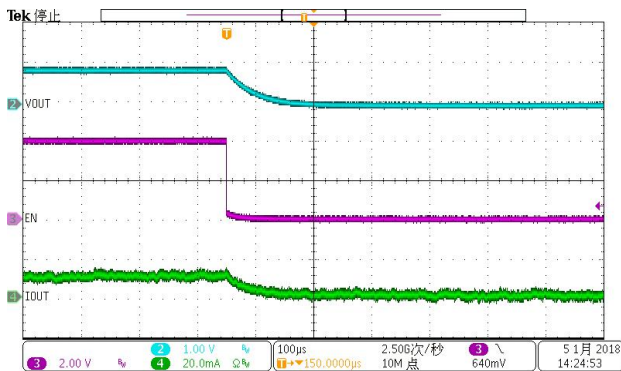

V_{IN}=1.9V, C_{OUT}=1μF, I_{OUT}=300mA

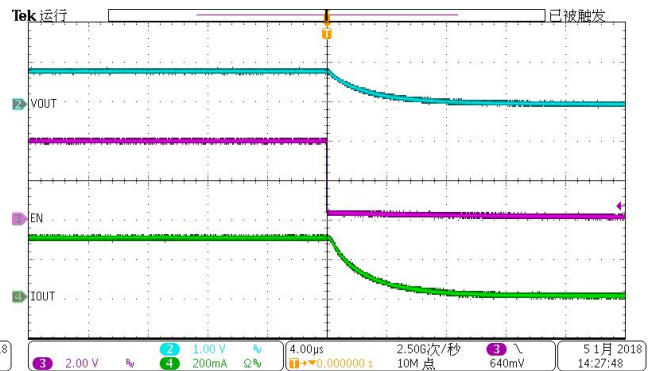

V_{OUT}=1.2V

V_{IN}=2.2V, C_{OUT}=1μF, I_{OUT}=10mA

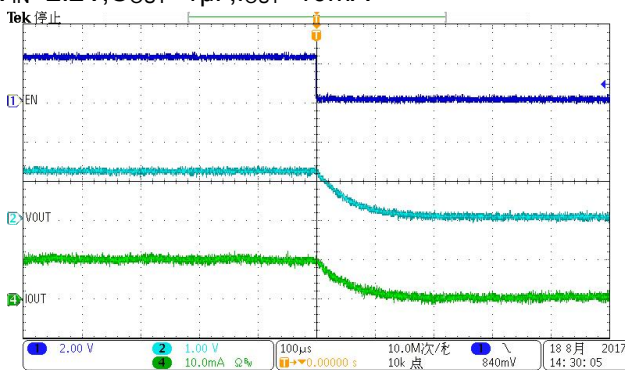

V_{IN}=2.2V, C_{OUT}=1μF, I_{OUT}=300mA

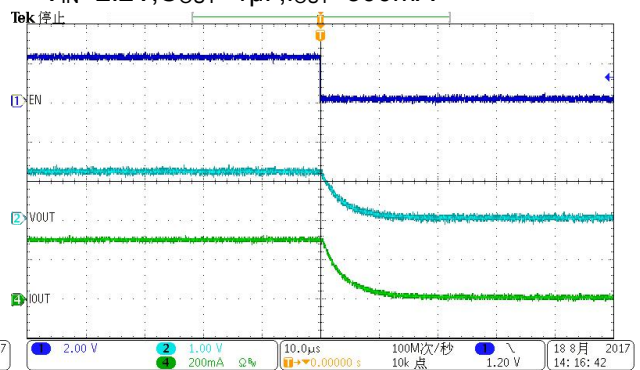

V_{OUT}=1.8V

V_{IN}=2.8V, C_{OUT}=1μF, I_{OUT}=10mA

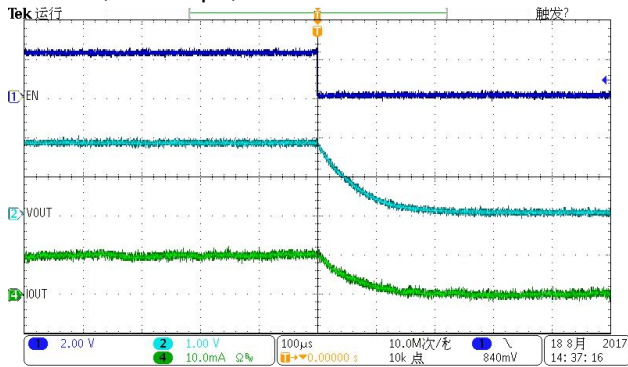

V_{IN}=2.8V, C_{OUT}=1μF, I_{OUT}=300mA

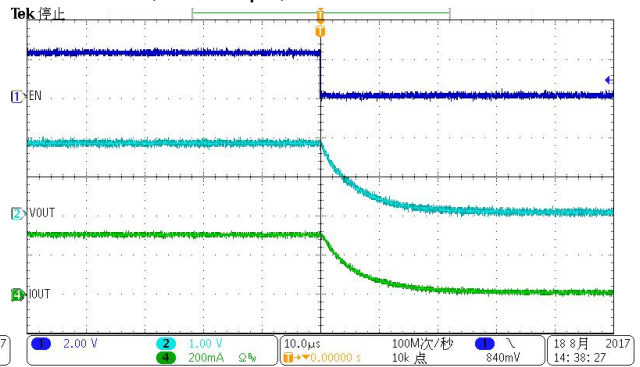

V_{OUT}=2.8V

V_{IN}=3.8V, C_{OUT}=1μF, I_{OUT}=10mA

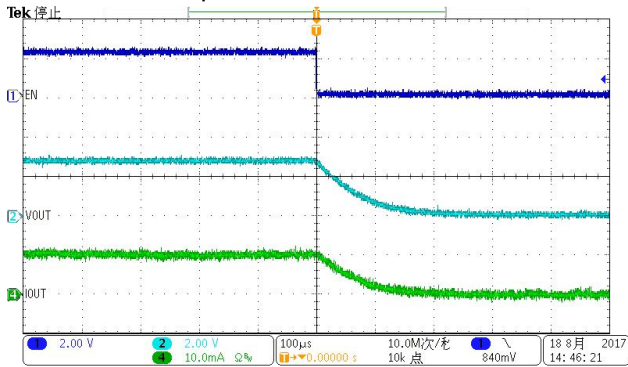

V_{IN}=3.8V, C_{OUT}=1μF, I_{OUT}=300mA

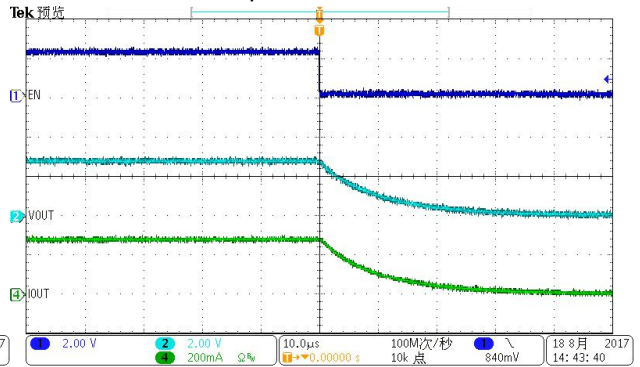

3. Load & Line Transient

Load step

V_{OUT}=0.9V

V_{IN}=1.9V, C_{OUT}=1μF, I_{OUT}=1mA-200mA in 1μs

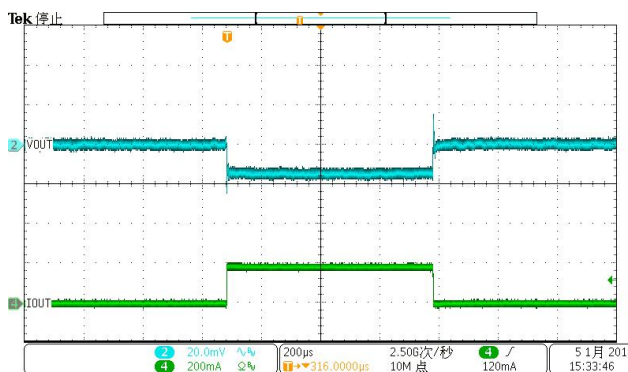

Line Step

V_{IN}=2.2V-3.2V in 20μs, C_{OUT}=1μF, I_{OUT}=1mA

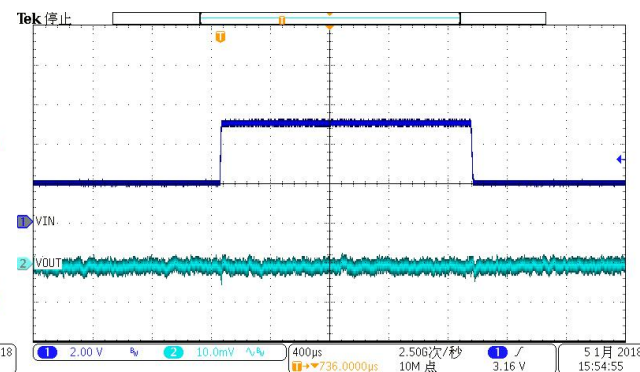

V_{OUT}=1.2V

V_{IN}=2.2V, C_{OUT}=1μF, I_{OUT}=1mA-200mA in 1μs

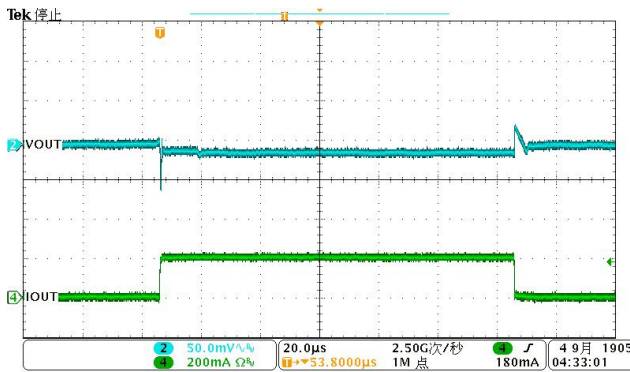

V_{IN}=2.2V-3.2V in 20μs, C_{OUT}=1μF, I_{OUT}=1mA

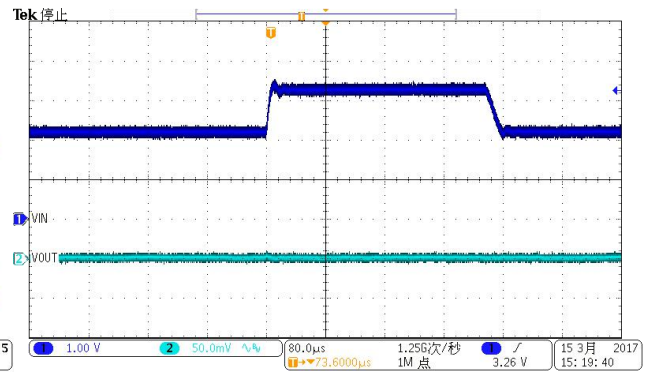

V_{OUT}=1.8V

V_{IN}=2.8V, C_{OUT}=1μF, I_{OUT}=1mA-300mA in 1μs

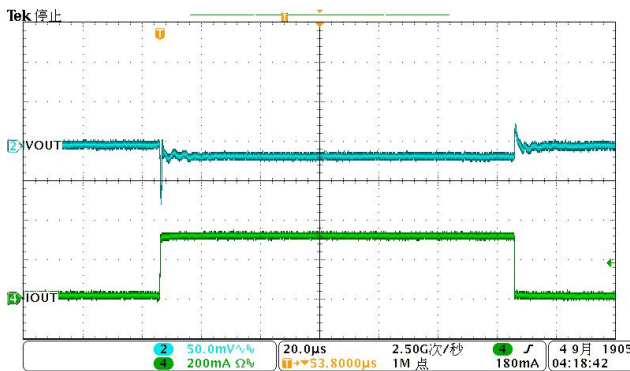

V_{IN}=2.8V-3.8V in 20μs, C_{OUT}=1μF, I_{OUT}=1mA

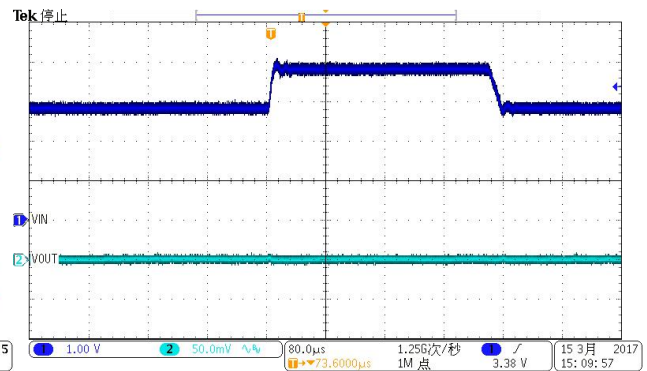

V_{OUT}=2.8V

V_{IN}=3.8V, C_{OUT}=1μF, I_{OUT}=1mA-300mA in 1μs

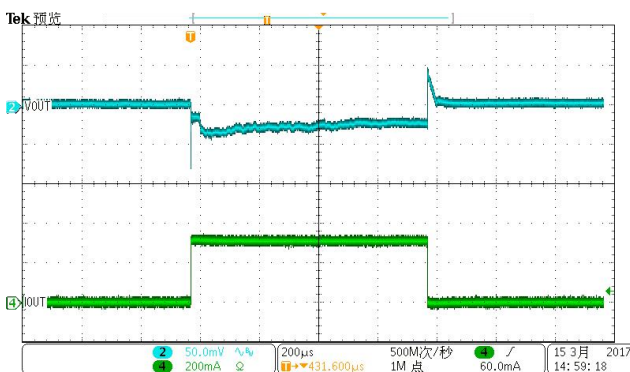

V_{IN}=3.8V-4.8V in 20μs, C_{OUT}=1μF, I_{OUT}=1mA

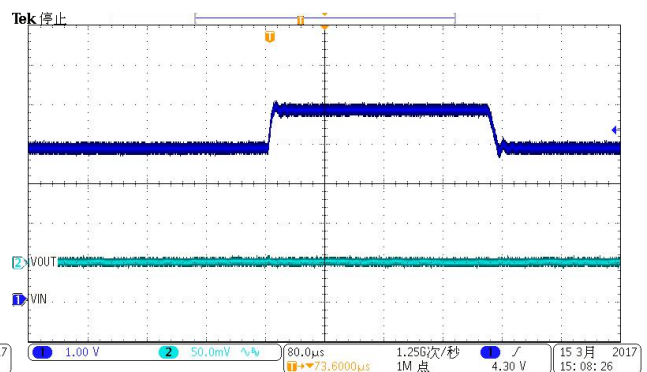

PACKAGE OUTLINE DIMENSIONS

SOT-23-5L

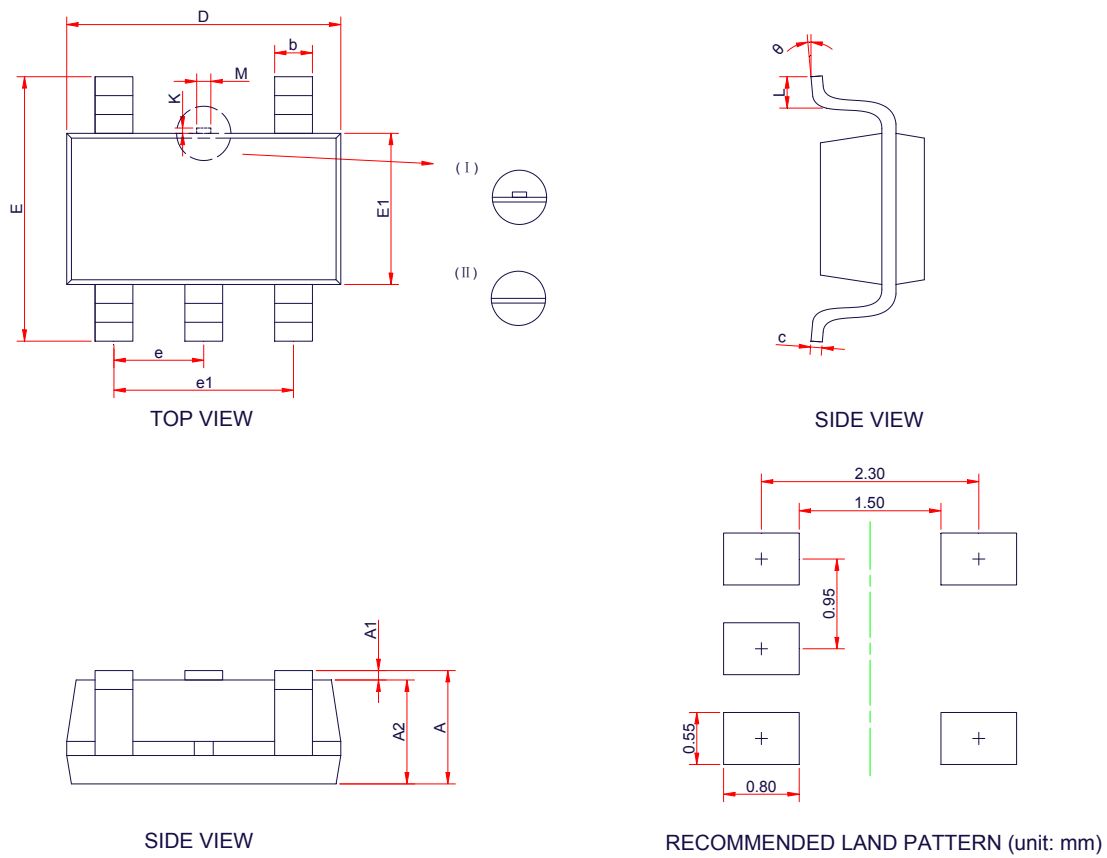

Symbol	Dimensions in Millimeters		
	Min.	Typ.	Max.
A	-	-	1.25
A1	0.00	-	0.15
A2	1.00	1.10	1.20
b	0.30	0.40	0.50
c	0.10	-	0.21
D	2.72	2.92	3.12
E	2.60	2.80	3.00
E1	1.40	1.60	1.80
e	0.95 BSC		
e1	1.90 BSC		
L	0.30	0.45	0.60
M	0.10	0.15	0.25
K	0.00	-	0.25
θ	0°	-	8°

TAPE AND REEL INFORMATION

Reel Dimensions

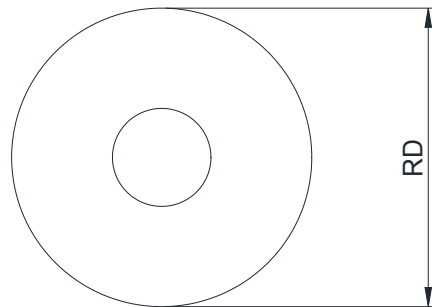

Tape Dimensions

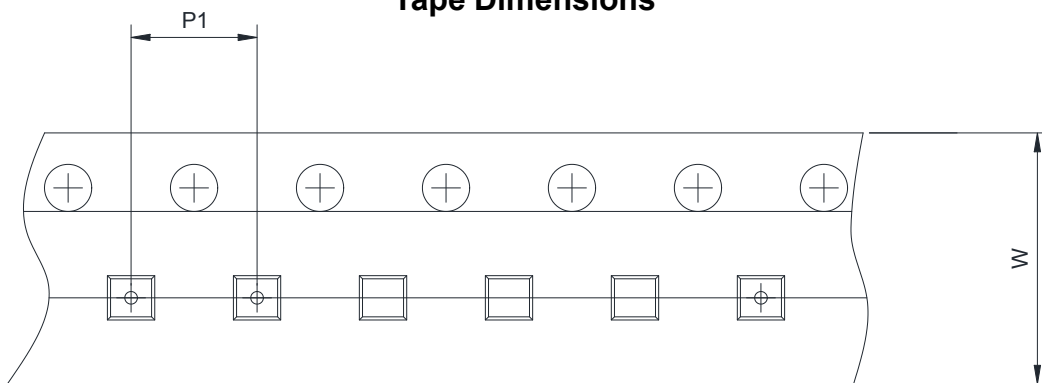

Quadrant Assignments For PIN1 Orientation In Tape

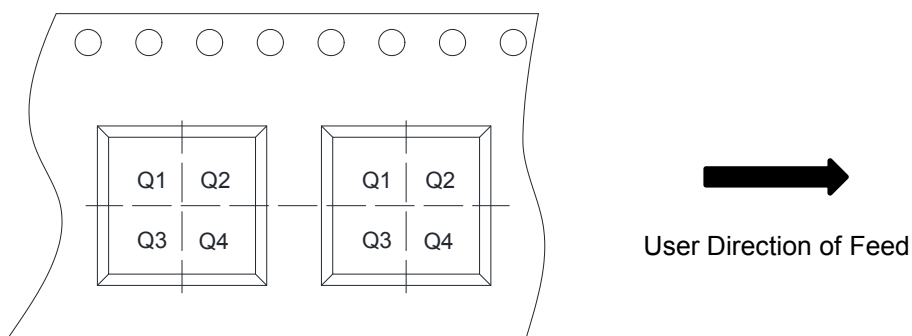

RD	Reel Dimension	<input checked="" type="checkbox"/> 7inch	<input type="checkbox"/> 13inch
W	Overall width of the carrier tape	<input checked="" type="checkbox"/> 8mm	<input type="checkbox"/> 12mm <input type="checkbox"/> 16mm
P1	Pitch between successive cavity centers	<input type="checkbox"/> 2mm	<input checked="" type="checkbox"/> 4mm <input type="checkbox"/> 8mm
Pin1	Pin1 Quadrant	<input type="checkbox"/> Q1	<input type="checkbox"/> Q2 <input checked="" type="checkbox"/> Q3 <input type="checkbox"/> Q4

ORDER INFORMATION

Ordering No.	Vout (V)	Package	Operating Temperature	Marking	Shipping
WL2836E08-5/TR	0.8	SOT-23-5L	-40~+85°C	2836 EhYW	Tape and Reel, 3000
WL2836E09-5/TR	0.9	SOT-23-5L	-40~+85°C	2836 EAYW	Tape and Reel, 3000
WL2836E10-5/TR	1.0	SOT-23-5L	-40~+85°C	2836 EBYW	Tape and Reel, 3000
WL2836E11-5/TR	1.1	SOT-23-5L	-40~+85°C	2836 EDYW	Tape and Reel, 3000
WL2836E12-5/TR	1.2	SOT-23-5L	-40~+85°C	2836 EEYW	Tape and Reel, 3000
WL2836E13-5/TR	1.3	SOT-23-5L	-40~+85°C	2836 EFYW	Tape and Reel, 3000
WL2836E15-5/TR	1.5	SOT-23-5L	-40~+85°C	2836 EGYW	Tape and Reel, 3000
WL2836E18-5/TR	1.8	SOT-23-5L	-40~+85°C	2836 EHYW	Tape and Reel, 3000
WL2836E25-5/TR	2.5	SOT-23-5L	-40~+85°C	2836 EKYW	Tape and Reel, 3000
WL2836E27-5/TR	2.7	SOT-23-5L	-40~+85°C	2836 EYYW	Tape and Reel, 3000
WL2836E28-5/TR	2.8	SOT-23-5L	-40~+85°C	2836 ELYW	Tape and Reel, 3000
WL2836E29-5/TR	2.9	SOT-23-5L	-40~+85°C	2836 EgYW	Tape and Reel, 3000
WL2836E30-5/TR	3.0	SOT-23-5L	-40~+85°C	2836 EMYW	Tape and Reel, 3000
WL2836E33-5/TR	3.3	SOT-23-5L	-40~+85°C	2836 ENYW	Tape and Reel, 3000