

256MB – 2x16Mx72 DDR SDRAM UNBUFFERED

FEATURES

- Double-data-rate architecture
- DDR200 and DDR266
 - JEDEC design specified
- Bi-directional data strobes (DQS)
- Differential clock inputs (CK & CK#)
- Programmable Read Latency 2,2.5 (clock)
- Programmable Burst Length (2,4,8)
- Programmable Burst type (sequential & interleave)
- Edge aligned data output, center aligned data input.
- Auto and self refresh
- Serial presence detect
- Dual Rank
- Power supply: 2.5V ± 0.20V
- JEDEC standard 184 pin DIMM package
 - JD3 PCB height: 30.48mm (1.20")

DESCRIPTION

The WED3EG7233S is a 2x16Mx72 Double Data Rate SDRAM memory module based on 128Mb DDR SDRAM component. The module consists of eighteen 16Mx8 DDR SDRAMs in 66 pin TSOP packages mounted on a 184 pin FR4 substrate.

Synchronous design allows precise cycle control with the use of system clock. Data I/O transactions are possible on both edges and Burst Lengths allow the same device to be useful for a variety of high bandwidth, high performance memory system applications.

* This product is under development, is not qualified or characterized and is subject to change or cancellation without notice.

NOTE: Consult factory for availability of:

- RoHS compliant products
- Vendor source control options
- Industrial temperature option

OPERATING FREQUENCIES

	DDR266 @CL=2	DDR266 @CL=2.5	DDR200 @CL=2
Clock Speed	133MHz	133MHz	100MHz
CL-tRCD-tRP	2-2-2	2.5-3-3	2-2-2



PIN CONFIGURATION

PIN	SYMBOL	PIN	SYMBOL	PIN	SYMBOL	PIN	SYMBOL
1	V _{REF}	47	DQS8	93	V _{SS}	139	V _{SS}
2	DQ0	48	A0	94	DQ4	140	DQM8
3	V _{SS}	49	CB2	95	DQ5	141	A10
4	DQ1	50	V _{SS}	96	V _{CCQ}	142	CB6
5	DQS0	51	CB3	97	DQM0	143	V _{CCQ}
6	DQ2	52	BA1	98	DQ6	144	CB7
7	V _{CC}	53	DQ32	99	DQ7	145	V _{SS}
8	DQ3	54	V _{CCQ}	100	V _{SS}	146	DQ36
9	NC	55	DQ33	101	NC	147	DQ37
10	NC	56	DQS4	102	NC	148	V _{CC}
11	V _{SS}	57	DQ34	103	A13*	149	DQM4
12	DQ8	58	V _{SS}	104	V _{CCQ}	150	DQ38
13	DQ9	59	BA0	105	DQ12	151	DQ39
14	DQS1	60	DQ35	106	DQ13	152	V _{SS}
15	V _{CCQ}	61	DQ40	107	DQM1	153	DQ44
16	CK1	62	V _{CCQ}	108	V _{CC}	154	RAS#
17	CK1#	63	WE#	109	DQ14	155	DQ45
18	V _{SS}	64	DQ41	110	DQ15	156	V _{CCQ}
19	DQ10	65	CAS#	111	CKE1	157	CS0#
20	DQ11	66	V _{SS}	112	V _{CCQ}	158	CS1#
21	CKE0	67	DQS5	113	NC	159	DQM5
22	V _{CCQ}	68	DQ42	114	DQ20	160	V _{SS}
23	DQ16	69	DQ43	115	A12	161	DQ46
24	DQ17	70	V _{CC}	116	V _{SS}	162	DQ47
25	DQS2	71	NC/CS2*	117	DQ21	163	CS3#
26	V _{SS}	72	DQ48	118	A11	164	V _{CCQ}
27	A9	73	DQ49	119	DQM2	165	DQ52
28	DQ18	74	V _{SS}	120	V _{CC}	166	DQ53
29	A7	75	CK2#	121	DQ22	167	NC
30	V _{CCQ}	76	CK2	122	A8	168	V _{CC}
31	DQ19	77	V _{CCQ}	123	DQ23	169	DQM6
32	A5	78	DQS6	124	V _{SS}	170	DQ54
33	DQ24	79	DQ50	125	A6	171	DQ55
34	V _{SS}	80	DQ51	126	DQ28	172	V _{CCQ}
35	DQ25	81	V _{SS}	127	DQ29	173	NC
36	DQS3	82	V _{CCID}	128	V _{CCQ}	174	DQ60
37	A4	83	DQ56	129	DQM3	175	DQ61
38	V _{CC}	84	DQ57	130	A3	176	V _{SS}
39	DQ26	85	V _{CC}	131	DQ30	177	DQM7
40	DQ27	86	DQS7	132	V _{SS}	178	DQ62
41	A2	87	DQ58	133	DQ31	179	DQ63
42	V _{SS}	88	DQ59	134	CB4	180	V _{CCQ}
43	A1	89	V _{SS}	135	CB5	181	SA0
44	CB0	90	NC	136	V _{CCQ}	182	SA1
45	CB1	91	SDA	137	CK0	183	SA2
46	V _{CC}	92	SCL	138	CK0#	184	V _{CCSPD}

PIN NAMES

A0-A13	Address input (Multiplexed)
BA0-BA1	Bank Select Address
DQ0-DQ63	Data Input/Output
CB0-CB7	Check bits
DQS0-DQS8	Data Strobe Input/Output
CK0, CK1, CK2	Clock Input
CK0#, CK1#, CK2#	Clock Input
CKE0, CKE1	Clock Enable input
CS0#, CS1#	Chip Select Input
RAS#	Row Address Strobe
CAS#	Column Address Strobe
WE#	Write Enable
DQM0-DQM8	Data-in-mask
V _{CC}	Power Supply
V _{CCQ}	Power Supply for DQS
V _{SS}	Ground
V _{REF}	Power Supply for Reference
V _{CCSPD}	Serial EEPROM Power Supply
SDA	Serial data I/O
SCL	Serial clock
SA0-SA2	Address in EEPROM
V _{CCID}	V _{CC} Identification Flag
NC	No Connect

* Not used

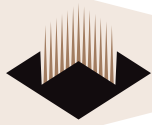

FUNCTIONAL BLOCK DIAGRAM

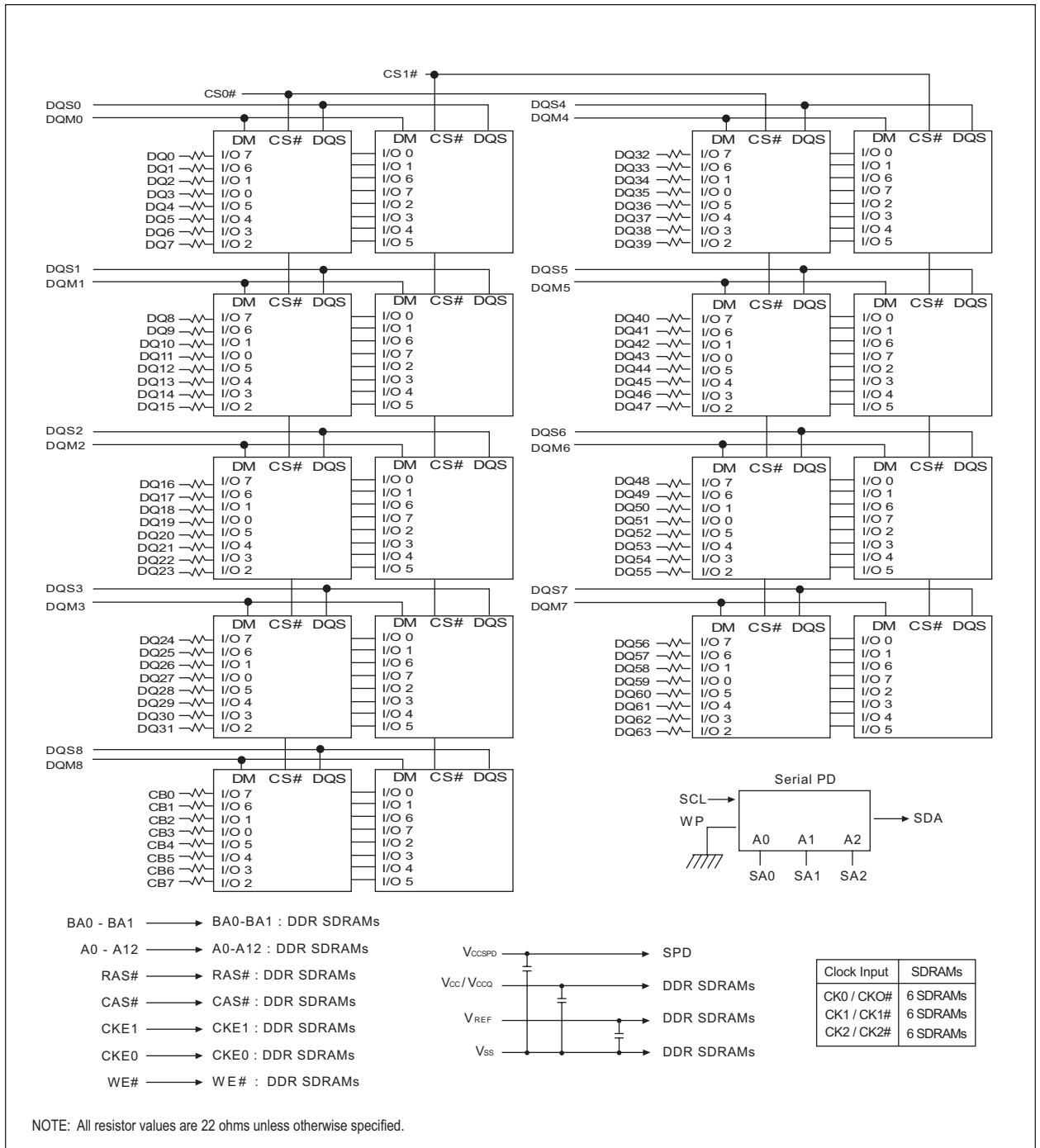

White Electronic Designs Corp. reserves the right to change products or specifications without notice.

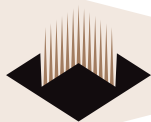

ABSOLUTE MAXIMUM RATINGS

Parameter	Symbol	Value	Units
Voltage on any pin relative to Vss	V _{IN} , V _{OUT}	-0.5 to 3.6	V
Voltage on Vcc supply relative to Vss	V _{CC} , V _{CCQ}	-1.0 to 3.6	V
Storage Temperature	T _{STG}	-55 to +150	°C
Power Dissipation	P _D	18	W
Short Circuit Current	I _{OS}	50	mA

Note: Permanent device damage may occur if 'ABSOLUTE MAXIMUM RATINGS' are exceeded.
Functional operation should be restricted to recommended operating condition.
Exposure to higher than recommended voltage for extended periods of time could affect device reliability

DC CHARACTERISTICS

0°C ≤ T_A ≤ 70°C, V_{CC} = 2.5V ± 0.2V

Parameter	Symbol	Min	Max	Unit
Supply Voltage	V _{CC}	2.3	2.7	V
Supply Voltage	V _{CCQ}	2.3	2.7	V
Reference Voltage	V _{REF}	1.15	1.35	V
Termination Voltage	V _{TT}	1.15	1.35	V
Input High Voltage	V _{IH}	V _{REF} + 0.15	V _{CCQ} + 0.3	V
Input Low Voltage	V _{IL}	-0.3	V _{REF} - 0.15	V
Output High Voltage	V _{OH}	V _{TT} + 0.76	—	V
Output Low Voltage	V _{OL}	—	V _{TT} - 0.76	V

CAPACITANCE

T_A = 25°C. f = 1MHz, V_{CC} = 2.5V ± 0.2V

Parameter	Symbol	Max	Unit
Input Capacitance (A0-A12)	C _{IN1}	59	pF
Input Capacitance (RAS#,CAS#,WE#)	C _{IN2}	59	pF
Input Capacitance (CKE0)	C _{IN3}	32	pF
Input Capacitance (CK0#,CK0)	C _{IN4}	56	pF
Input Capacitance (CS0#)	C _{IN5}	32	pF
Input Capacitance (DQM0-DQM8)	C _{IN6}	13	pF
Input Capacitance (BA0-BA1)	C _{IN7}	59	pF
Data input/output capacitance (DQ0-DQ63)(DQS)	C _{OUT}	13	pF
Data input/output capacitance (CB0-CB7)	C _{OUT}	13	pF

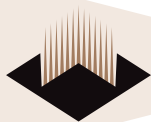

I_{DD} SPECIFICATIONS AND TEST CONDITIONS

Recommended operating conditions, 0°C ≤ T_A ≤ 70°C, V_{CCQ} = 2.5V ± 0.2V, V_{CC} = 2.5V ± 0.2V

Includes DDR SDRAM component only

Parameter	Symbol	Conditions	DDR266@CL=2.0 Max	DDR266@CL=2.5 Max	DDR200@CL=2 Max	Units
Operating Current	I _{DD0}	One device bank; Active - Precharge; t _{RC} =t _{RC} (MIN); t _{CK} =t _{CK} (MIN); DQ, DM and DQS inputs changing once per clock cycle; Address and control inputs changing once every two cycles.	TBD	1845	1845	mA
Operating Current	I _{DD1}	One device bank; Active-Read-Precharge Burst = 2; t _{RC} =t _{RC} (MIN); t _{CK} =t _{CK} (MIN); I _{OUT} = 0mA; Address and control inputs changing once per clock cycle.	TBD	2205	2205	mA
Precharge Power-Down Standby Current	I _{DD2P}	All device banks idle; Power-down mode; t _{CK} =t _{CK} (MIN); CKE=(low)	TBD	72	72	mA
Idle Standby Current	I _{DD2F}	CS# = High; All device banks idle; t _{CK} =t _{CK} (MIN); CKE = high; Address and other control inputs changing once per clock cycle. V _{IN} = V _{REF} for DQ, DQS and DM.	TBD	810	810	mA
Active Power-Down Standby Current	I _{DD3P}	One device bank active; Power-Down mode; t _{CK} (MIN); CKE=(low)	TBD	450	450	mA
Active Standby Current	I _{DD3N}	CS# = High; CKE = High; One device bank; Active-Precharge; t _{RC} =t _{RAS} (MAX); t _{CK} =t _{CK} (MIN); DQ, DM and DQS inputs changing twice per clock cycle; Address and other control inputs changing once per clock cycle.	TBD	900	900	mA
Operating Current	I _{DD4R}	Burst = 2; Reads; Continuous burst; One device bank active; Address and control inputs changing once per clock cycle; T _{CK} = T _{CK} (MIN); I _{OUT} = 0mA.	TBD	2250	2250	mA
Operating Current	I _{DD4W}	Burst = 2; Writes; Continuous burst; One device bank active; Address and control inputs changing once per clock cycle; t _{CK} =t _{CK} (MIN); DQ, DM and DQS inputs changing once per clock cycle.	TBD	2115	2115	mA
Auto Refresh Current	I _{DD5}	t _{RC} = t _{RC} (MIN)	TBD	3015	3015	mA
Self Refresh Current	I _{DD6}	CKE ≤ 0.2V	TBD	72	72	mA
Operating Current	I _{DD7A}	Four bank interleaving Reads (BL=4) with auto precharge with t _{RC} =t _{RC} (MIN); t _{CK} =t _{CK} (MIN); Address and control inputs change only during Active Read or Write commands.	TBD	4050	4050	mA



DETAILED TEST CONDITIONS FOR DDR SDRAM I_{DD1} & I_{DD7A}

I_{DD1} : OPERATING CURRENT : ONE BANK

1. Typical Case : $V_{CC}=2.5V, T=25^{\circ}C$
2. Worst Case : $V_{CC}=2.7V, T=10^{\circ}C$
3. Only one bank is accessed with t_{RC} (min), Burst Mode, Address and Control inputs on NOP edge are changing once per clock cycle. $I_{OUT} = 0mA$
4. Timing Patterns :
 - DDR200 (100 MHz, CL=2) : $t_{CK}=10ns, CL2, BL=4, t_{RCD}=2*t_{CK}, t_{RAS}=5*t_{CK}$
Read : A0 N R0 N N P0 N A0 N - repeat the same timing with random address changing; 50% of data changing at every burst
 - DDR266 (133MHz, CL=2.5) : $t_{CK}=7.5ns, CL=2.5, BL=4, t_{RCD}=3*t_{CK}, t_{RC}=9*t_{CK}, t_{RAS}=5*t_{CK}$
Read : A0 N N R0 N P0 N N A0 N - repeat the same timing with random address changing; 50% of data changing at every burst
 - DDR266 (133MHz, CL=2) : $t_{CK}=7.5ns, CL=2, BL=4, t_{RCD}=3*t_{CK}, t_{RC}=9*t_{CK}, t_{RAS}=5*t_{CK}$
Read : A0 N N R0 N P0 N N A0 N - repeat the same timing with random address changing; 50% of data changing at every burst

I_{DD7A} : OPERATING CURRENT : FOUR BANKS

1. Typical Case : $V_{CC}=2.5V, T=25^{\circ}C$
2. Worst Case : $V_{CC}=2.7V, T=10^{\circ}C$
3. Four banks are being interleaved with t_{RC} (min), Burst Mode, Address and Control inputs on NOP edge are not changing. $I_{OUT}=0mA$
4. Timing Patterns :
 - DDR200 (100 MHz, CL=2) : $t_{CK}=10ns, CL2, BL=4, t_{RRD}=2*t_{CK}, t_{RCD}=3*t_{CK}$, Read with Autoprecharge
Read : A0 N A1 R0 A2 R1 A3 R2 A0 R3 A1 R0 - repeat the same timing with random address changing; 100% of data changing at every burst
 - DDR266 (133MHz, CL=2.5) : $t_{CK}=7.5ns, CL=2.5, BL=4, t_{RRD}=3*t_{CK}, t_{RCD}=3*t_{CK}$
Read with Autoprecharge
Read : A0 N A1 R0 A2 R1 A3 R2 N R3 A0 N A1 R0 - repeat the same timing with random address changing; 100% of data changing at every burst
 - DDR266 (133MHz, CL=2) : $t_{CK}=7.5ns, CL2=2, BL=4, t_{RRD}=2*t_{CK}, t_{RCD}=2*t_{CK}$
Read : A0 N A1 R0 A2 R1 A3 R2 N R3 A0 N A1 R0 - repeat the same timing with random address changing; 100% of data changing at every burst

Legend:

A = Activate, R = Read, W = Write, P = Precharge, N = NOP

A (0-3) = Activate Bank 0-3

R (0-3) = Read Bank 0-3

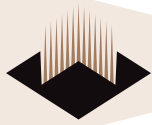

**DDR SDRAM COMPONENT ELECTRICAL CHARACTERISTICS AND
RECOMMENDED AC OPERATING CONDITIONS**

0°C ≤ T_A ≤ +70°C; V_{CC} = +2.5V ± 0.2V, V_{CCA} = +2.5V ± 0.2V

AC Characteristics			262		265, 202			
Parameter	Symbol	Min	Max	Min	Max	Units	Notes	
Access window of DQs from CK, CK#	t _{AC}	-0.75	+0.75	-0.75	+0.75	ns		
CK high-level width	t _{CH}	0.45	0.55	0.45	0.55	t _{CK}	16	
CK low-level width	t _{CL}	0.45	0.55	0.45	0.55	t _{CK}	16	
Clock cycle time	CL=2.5 t _{CK} (2.5)	7.5	13	7.5	13	ns	22	
	CL=2 t _{CK} (2)	7.5	13	10	13	ns	22	
DQ and DM input hold time relative to DQS	t _{DH}	0.5		0.5		ns	14,17	
DQ and DM input setup time relative to DQS	t _{DS}	0.5		0.5		ns	14,17	
DQ and DM input pulse width (for each input)	t _{DIPW}	1.75		1.75		ns	17	
Access window of DQS from CK, CK#	t _{DQSK}	-0.75	+0.75	-0.75	+0.75	ns		
DQS input high pulse width	t _{DQSH}	0.35		0.35		t _{CK}		
DQS input low pulse width	t _{DQSL}	0.35		0.35		t _{CK}		
DQS-DQ skew, DQS to last DQ valid, per group, per access	t _{DQSQ}		0.5		0.5	ns	13,14	
Write command to first DQS latching transition	t _{DQSS}	0.75	1.25	0.75	1.25	t _{CK}		
DQS falling edge to CK rising - setup time	t _{DSS}	0.2		0.2		t _{CK}		
DQS falling edge from CK rising - hold time	t _{DSSH}	0.2		0.2		t _{CK}		
Half clock period	t _{HP}	t _{CH} , t _{CL}		t _{CH} , t _{CL}		ns	18	
Data-out high-impedance window from CK, CK#	t _{HZ}		+0.75		+0.75	ns	8,19	
Data-out low-impedance window from CK, CK#	t _{LZ}	-0.75		-0.75		ns	8,20	
Address and control input hold time (fast slew rate)	t _{HF}	0.90		0.90		ns	6	
Address and control input set-up time (fast slew rate)	t _{SF}	0.90		0.90		ns	6	
Address and control input hold time (slow slew rate)	t _{HS}	1		1		ns	6	
Address and control input setup time (slow slew rate)	t _{SS}	1		1		ns	6	
Address and control input pulse width (for each input)	t _{PW}	2.2		2.2		ns		
LOAD MODE REGISTER command cycle time	t _{M RD}	15		15		ns		
DQ-DQS hold, DQS to first DQ to go non-valid, per access	t _{QH}	t _{HP} -t _{QHS}		t _{HP} -t _{QHS}		ns	13,14	
Data hold skew factor	t _{QHS}		0.75		0.75	ns		
ACTIVE to PRECHARGE command	t _{RAS}	45	120,000	45	120,000	ns	15	
ACTIVE to READ with Auto precharge command	t _{RAP}	20		20		ns		
ACTIVE to ACTIVE/AUTO REFRESH command period	t _{RC}	65		65		ns		
AUTO REFRESH command period	t _{RFC}	75		75		ns	21	

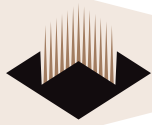

**DDR SDRAM COMPONENT ELECTRICAL CHARACTERISTICS AND
RECOMMENDED AC OPERATING CONDITIONS (continued)**

0°C ≤ T_A ≤ +70°C; V_{CC} = +2.5V ± 0.2V, V_{CCQ} = +2.5V ± 0.2V

AC Characteristics		262		265, 202			
Parameter	Symbol	Min	Max	Min	Max	Units	Notes
ACTIVE to READ or WRITE delay	t _{RCD}	20		20		ns	
PRECHARGE command period	t _{RP}	20		20		ns	
DQS read preamble	t _{RPRE}	0.9	1.1	0.9	1.1	t _{CK}	19
DQS read postamble	t _{RPST}	0.4	0.6	0.4	0.6	t _{CK}	
ACTIVE bank a to ACTIVE bank b command	t _{RRD}	15		15		ns	
DQS write preamble	t _{WPRE}	0.25		0.25		t _{CK}	
DQS write preamble setup time	t _{WPRES}	0		0		ns	10,11
DQS write postamble	t _{WPST}	0.4	0.6	0.4	0.6	t _{CK}	9
Write recovery time	t _{WR}	15		15		ns	
Internal WRITE to READ command delay	t _{WTR}	1		1		t _{CK}	
Data valid output window	NA	t _{AH} -t _{DAQA}		t _{AH} -t _{DAQA}		ns	13
REFRESH to REFRESH command interval	t _{REFC}		70.3		70.3	μs	12
Average periodic refresh interval	t _{REFI}		7.8		7.8	μs	12
Terminating voltage delay to V _{CC}	t _{VD}	0		0		ns	
Exit SELF REFRESH to non-READ command	t _{XSNR}	75		75		ns	
Exit SELF REFRESH to READ command	t _{XSRD}	200		200		t _{CK}	

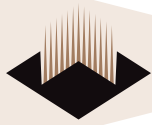

ORDERING INFORMATION FOR JD3

Part Number	Speed	CAS Latency	t _{RC} D	t _{RP}	Height*
WED3EG7233S262JD3	133MHz/266Mb/s	2	2	2	30.48 (1.20")
WED3EG7233S265JD3	133MHz/266Mb/s	2.5	3	3	30.48 (1.20")
WED3EG7233S202JD3	100MHz/200Mb/s	2	2	2	30.48 (1.20")

- NOTES:
- Consult Factory for availability of RoHS compliant products. (G = RoHS Compliant)
 - Vendor specific part numbers are used to provide memory components source control. The place holder for this is shown as lower case "x" in the part numbers above and is to be replaced with the respective vendors code. Consult factory for qualified sourcing options. (M = Micron, S = Samsung & consult factory for others)
 - Consult factory for availability of industrial temperature (-40°C to 85°C) option

PACKAGE DIMENSIONS FOR JD3

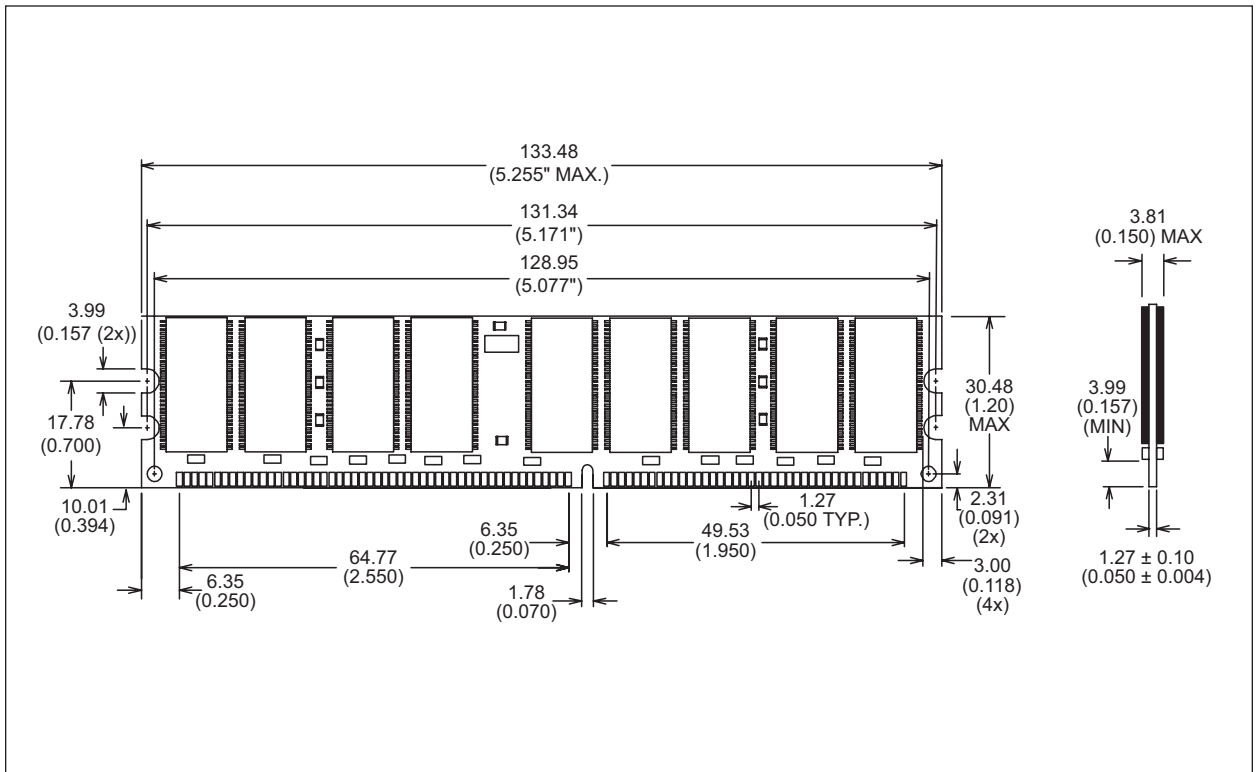

* ALL DIMENSIONS ARE IN MILLIMETERS AND (INCHES)

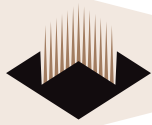

ORDERING INFORMATION FOR D3

Part Number	Speed	CAS Latency	t _{RC} D	t _{RP}	Height*
WED3EG7233S262D3	133MHz/266Mb/s	2	2	2	30.48 (1.20")
WED3EG7233S265D3	133MHz/266Mb/s	2.5	3	3	30.48 (1.20")
WED3EG7233S202D3	100MHz/200Mb/s	2	2	2	30.48 (1.20")

- NOTES:
- Consult Factory for availability of RoHS compliant products. (G = RoHS Compliant)
 - Vendor specific part numbers are used to provide memory components source control. The place holder for this is shown as lower case "x" in the part numbers above and is to be replaced with the respective vendors code. Consult factory for qualified sourcing options. (M = Micron, S = Samsung & consult factory for others)
 - Consult factory for availability of industrial temperature (-40°C to 85°C) option

PACKAGE DIMENSIONS FOR D3

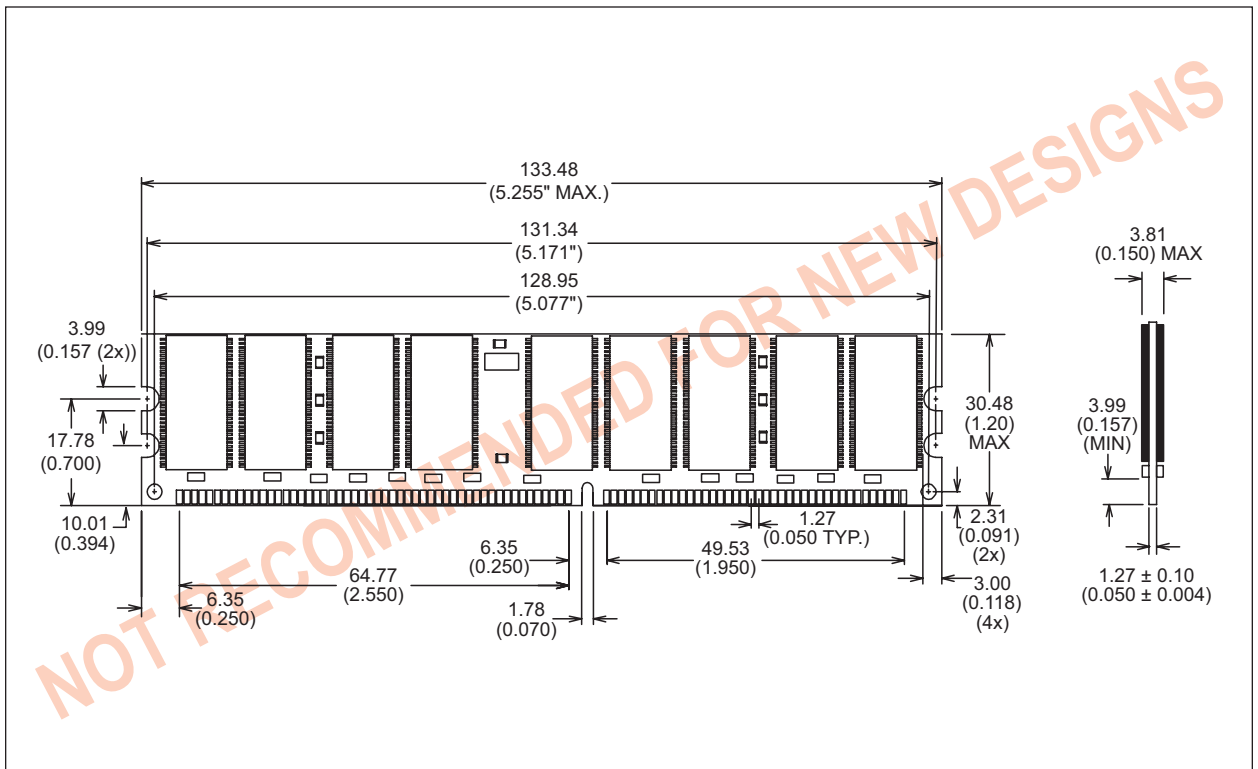

* ALL DIMENSIONS ARE IN MILLIMETERS AND (INCHES)

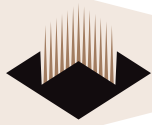

Document Title

256MB – 2x16Mx72 DDR SDRAM UNBUFFERED

Revision History

Rev #	History	Release Date	Status
Rev A	Created Datasheet	5-22-02	Advanced
Rev 0	0.1 Updated all specs (IDD, CAP, AC's)	5-05	Preliminary
	0.2 Added JEDEC standard PCB (JD3) option		
	0.3 D3 PCB option is "NOT RECOMMENDED FOR NEW DESIGNS"		
	0.4 Moved from Advanced to Preliminary		