

ECM Series



- Compact Size - High Power Density
- Industrial & Medical Approvals
- Low Leakage Current
- Level B Conducted Emissions
- EN61000-3-2, -3 Compliant
- Convection-cooled
- Class II Approved 40-60 W Models

Specification

Input

Input Voltage	• 90-264 VAC (120-370 VDC)
Input Frequency	• 47-63 Hz; 440 Hz
Input Current	• 40 W: 0.4 A max at 230 VAC 60 W: 0.6 A max at 230 VAC 100 W: 0.9 A max at 230 VAC
Inrush Current	• 40 A max at 230 VAC
Earth Leakage Current	• <125 μ A at 115 VAC/60 Hz <210 μ A at 230 VAC/50 Hz
Input Protection	• Internal 3.15 A fuse in line and neutral

Output

Output Voltage	• See tables
Output Voltage Trim	• $\pm 5\%$ on 3.3 V & 5 V versions, $\pm 10\%$ on other single output models and V1 of multi-output models. See note 1 for ECM40/60 models
Initial Set Accuracy	• $\pm 1.0\%$ V1, $\pm 5\%$ V2, V3 & V4
Minimum Load	• See tables
Start Up Delay	• 2 s max
Start Up Rise Time	• 50 ms
Hold Up Time	• 16/75 ms min at 115/230 VAC
Line Regulation	• $\pm 0.5\%$
Load Regulation	• $\pm 1\%$ single output models; $\pm 3\%$ V1, $\pm 5\%$ V2 & V3 ECM40/60 multi-output models. $\pm 1\%$ V1 & V2, $\pm 5\%$ V3 & V4 ECM100
Cross Regulation	• 2% on ECM40/60 only
Over/Undershoot	• None at turn on/off
Transient Response	• 4% max. deviation, recovery to within 1% in 500 μ s for a 25% load change
Ripple & Noise	• 1% pk-pk, 20 MHz bandwidth
Overvoltage Protection	• 115-135% Vnom, recycle input to reset
Overload Protection	• 110-150% on primary power limit, auto recovery
Short Circuit Protection	• Trip and restart (Hiccup mode)
Temperature Coefficient	• 0.05%/ $^{\circ}$ C

General

Efficiency	• 80-85% depending on model
Isolation	• 4000 VAC Input to Output 1500 VAC Input to Ground 500 VAC Output to Ground
Switching Frequency	• 70 kHz typical
Power Density	• 60 W: 6.25 W/In ³ 100 W: 7.40 W/In ³
MTBF	• 250 kHrs per MIL-HDBK-217F

Environmental

Operating Temperature	• 0 $^{\circ}$ C to +70 $^{\circ}$ C. Refer to derating curves for specific operating limitations.
Cooling	• Convection & fan-cooled ratings (see derating curves)
Operating Humidity	• 95% RH, non-condensing
Storage Temperature	• -20 $^{\circ}$ C to +85 $^{\circ}$ C
Operating Altitude	• 3000 m
Shock	• 30 g pk, half sine, 6 axes
Vibration	• 2 g rms, 5 Hz to 500 kHz, 3 axes

EMC & Safety

Emissions	• EN60601-1-2, EN61204-3, FCC 20780, EN55022 & EN55011, level B conducted
Harmonic Currents	• EN61000-3-2
Voltage Flicker	• EN61000-3-3
ESD Immunity	• EN61000-4-2, level 2 Perf Criteria A
Radiated Immunity	• EN61000-4-3, 10 V/m Perf Criteria A
EFT/Burst	• EN61000-4-4, level 3 Perf Criteria A
Surge	• EN61000-4-5, level 3 Perf Criteria A
Conducted Immunity	• EN61000-4-6, 10 V Perf Criteria A
Dips & Interruptions	• EN61000-4-11, 30% 10 ms, 60% 100 ms, 100% 5000 ms Perf Criteria A, B, B
Safety Approvals	• EN60950, UL60950, CSA 22.2 601.1, EN60601-1, UL60601-1, CCC pending, contact sales

Models and Ratings

Max Power	Output 1		Output 2		Output 3		Model Number ⁽²⁾
	Voltage	Current Min/Max ⁽³⁾	Voltage	Current Min/Max	Voltage	Current Min/Max	
40 W	+5.0 V	0.0 A/8.0 A					ECM40US05 ^{†^}
	+7.0 V	0.0 A/5.7 A					ECM40US07
	+9.0 V	0.0 A/4.4 A					ECM40US09 [^]
	+12.0 V	0.0 A/3.5 A					ECM40US12 ^{†^}
	+15.0 V	0.0 A/2.7 A					ECM40US15 ^{†^}
	+18.0 V	0.0 A/2.2 A					ECM40US18
	+24.0 V	0.0 A/1.7 A					ECM40US24 ^{†^}
	+33.0 V	0.0 A/1.2 A					ECM40US33
	+48.0 V	0.0 A/0.9 A					ECM40US48 ^{†^}
	+5.0 V	0.5 A/6.0 A	+12.0 V	0.1 A/2.0 A			ECM40UD21
	+5.0 V	0.5 A/6.0 A	+15.0 V	0.1 A/1.5 A			ECM40UD22
	+5.0 V	0.5 A/6.0 A	+12.0 V	0.1 A/2.0 A	-12.0 V	0.0 A/0.5 A	ECM40UT31 ^{†^}
	+5.0 V	0.5 A/6.0 A	+24.0 V	0.1 A/1.0 A	-12.0 V	0.0 A/0.5 A	ECM40UT32 [†]
	+5.0 V	0.5 A/6.0 A	+15.0 V	0.1 A/1.5 A	-15.0 V	0.0 A/0.5 A	ECM40UT33 ^{†^}
	+3.3 V	0.5 A/6.0 A	+5.0 V	0.1 A/1.5 A	+12.0 V	0.0 A/0.5 A	ECM40UT34 ^{†^}
	+5.0 V	0.5 A/6.0 A	+3.3 V	0.1 A/1.5 A	+12.0 V	0.0 A/0.5 A	ECM40UT35 [†]

Notes

- V2 will track a change in V1 by the same percentage change in voltage as V1 is trimmed.
- To receive unit with cover fitted, add suffix '-C' to model number. For Class I operation only.
- A 120% peak load can be taken for up to 100 ms with a 25% duty cycle. Average load not to exceed 40 W.

[†] Available from Farnell. See pages 204-206. [^] Available from Newark. See pages 207-208.

Mechanical Details

4.00 (101.6)
3.75 (95.25)
2.00 (50.8)
1.75 (44.45)
4X ø0.156 (3.96) mounting holes
ø0.312 (7.92) clearance top and bottom
V Adj.
SMD component height
1.20 (30.5)
0.14 (3.5)

Input Connector J1	
Pin 1	Line
Pin 2	Neutral

J1 mates with Molex housing 43061-0003 & Molex series 5194 crimp terminals

Output Connector J2		
Pin	Single	Multi
1	+V1	+V1
2	+V1	+V1
3	RTN	RTN
4	RTN	RTN
5	NC	-V3
6	NC	+V2

J2 mates with Molex housing 43061-0006 & Molex series 5194 crimp terminals

Weight: approx. 0.33 lb (150 g)

Notes

- All dimensions in inches (mm). Tolerance .xx = ±0.02 (0.50); .xxx = ±0.01 (0.25)
- Cable harnesses with 300 mm wire available.
For single output models, order part number ECM40/60S LOOM[†].
For multi-output models, order part number ECM40/60DT LOOM[†].
- Mating connector kit available. Order part number ECM40/60 CONKIT[†].
- Covers available. Order part number ECM40/60 COVER^{†^}. Cover dimensions are 4.49 x 2.52 x 1.52 (114 x 64 x 38.5)

Derating Curves

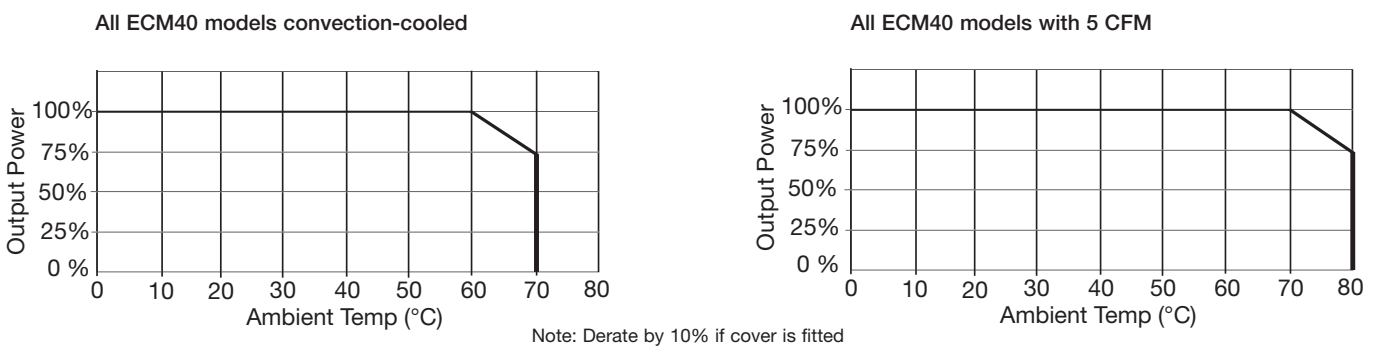

Consult longform datasheet for installation information regarding optimum thermal ratings in convection-cooled applications.

Models and Ratings

Max Power	Output 1		Output 2		Output 3		Model Number ⁽²⁾
	Voltage	Current Min/Max ⁽³⁾	Voltage	Current Min/Max	Voltage	Current Min/Max	
60 W	+5.0 V	0.0 A/12.00 A					ECM60US05†^
	+7.0 V	0.0 A/8.60 A					ECM60US07
	+9.0 V	0.0 A/6.70 A					ECM60US09^
	+12.0 V	0.0 A/5.00 A					ECM60US12†^
	+15.0 V	0.0 A/4.00 A					ECM60US15†^
	+18.0 V	0.0 A/3.30 A					ECM60US18
	+20.0 V	0.0 A/3.00 A					ECM60US20
	+24.0 V	0.0 A/2.50 A					ECM60US24†^
	+33.0 V	0.0 A/1.80 A					ECM60US33
	+48.0 V	0.0 A/1.25 A					ECM60US48†^
	+5.0 V	0.5 A/8.00 A	+12.0 V	0.1 A/3.0 A			ECM60UD21
	+5.0 V	0.5 A/8.00 A	+15.0 V	0.1 A/2.5 A			ECM60UD22
	+5.0 V	0.5 A/8.00 A	+12.0 V	0.1 A/3.0 A	-12.0 V	0.0 A/0.5 A	ECM60UT31†^
	+5.0 V	0.5 A/8.00 A	+24.0 V	0.1 A/1.5 A	-12.0 V	0.0 A/0.5 A	ECM60UT32†
	+5.0 V	0.5 A/8.00 A	+15.0 V	0.1 A/2.5 A	-15.0 V	0.0 A/0.5 A	ECM60UT33†^
	+3.3 V	0.5 A/8.00 A	+5.0 V	0.1 A/1.5 A	+12.0 V	0.0 A/0.5 A	ECM60UT34†^
	+5.0 V	0.5 A/8.00 A	+3.3 V	0.1 A/1.5 A	+12.0 V	0.0 A/0.5 A	ECM60UT35†

Notes

- V2 will track a change in V1 by the same percentage change in voltage as V1 is trimmed.
- To receive unit with cover fitted, add suffix '-C' to model number. For Class I operation only.
- A 120% peak load can be taken for up to 100 ms with a 25% duty cycle. Average load not to exceed 60 W.
- 48 V DC input version of 12 V single output model available in OEM quantities (DCM6048S12). Contact sales for details.

† Available from Farnell. See pages 204-206.

^ Available from Newark. See pages 207-208.

Mechanical Details

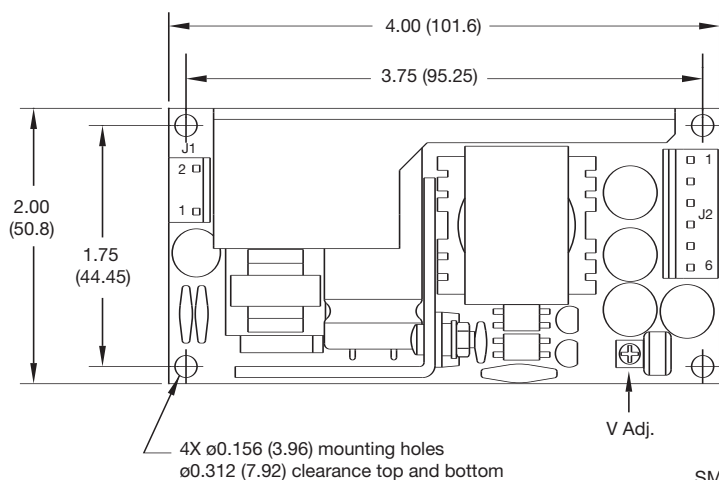

Input Connector J1	
Pin 1	Line
Pin 2	Neutral

J1 mates with Molex housing 43061-0003 & Molex series 5194 crimp terminals. Optional ground (0.25 faston) tab available, contact sales.

Output Connector J2		
Pin	Single	Multi
1	+V1	+V1
2	+V1	+V1
3	RTN	RTN
4	RTN	RTN
5	NC	-V3
6	NC	+V2

J2 mates with Molex housing 43061-0006 & Molex series 5194 crimp terminals. Weight: approx. 0.33 lb (150 g)

Notes

- All dimensions in inches (mm). Tolerance .xx = ±0.02 (0.50); .xxx = ±0.01 (0.25)
- Cable harnesses with 300 mm wire available. For single output models, order part number ECM40/60S LOOM†. For multi-output models, order part number ECM40/60DT LOOM†.
- Mating connector kit available. Order part number ECM40/60 CONKIT†.
- Covers available. Order part number ECM40/60 COVER^†. Cover dimensions are 4.49 x 2.52 x 1.52 (114 x 64 x 38.5).
- Selected single output models available in a 3" x 5" footprint for OEM quantities. Contact sales for details.

Derating Curves

All ECM60 models convection-cooled

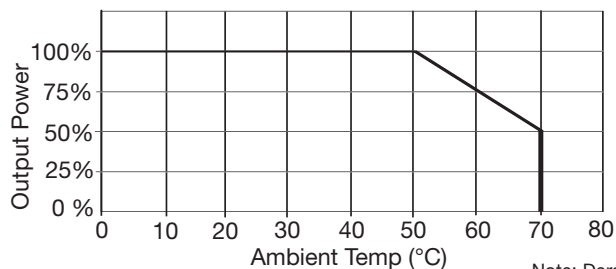

All ECM60 models with 5 CFM

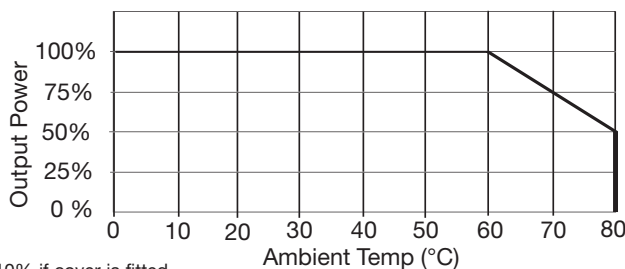

Note: Derate by 10% if cover is fitted

Consult longform datasheet for installation information regarding optimum thermal ratings in convection-cooled applications.

Models and Ratings

Single Output Models

Output Voltage	Output Current			Model Number ^{†,‡}
	Minimum	Maximum	with 5 CFM Cooling	
+3.3 V	0.0 A	15.0 A	20.0 A	ECM100US03*†^
+5.0 V	0.0 A	15.0 A	20.0 A	ECM100US05*†^
+7.0 V	0.0 A	11.4 A	14.3 A	ECM100US07*
+9.0 V	0.0 A	8.8 A	11.1 A	ECM100US09*†
+12.0 V	0.0 A	7.5 A	8.3 A	ECM100US12*†^
+15.0 V	0.0 A	6.0 A	6.6 A	ECM100US15*†^
+18.0 V	0.0 A	5.0 A	5.5 A	ECM100US18*
+24.0 V	0.0 A	4.1 A	4.1 A	ECM100US24*†^
+33.0 V	0.0 A	3.0 A	3.0 A	ECM100US33*
+48.0 V	0.0 A	2.1 A	2.1 A	ECM100US48*†^

Multi Output Models

Output Power		Output 1		Output 2		Output 3		Output 4		Model Number ^{†,‡}
Convection Cooled	Forced Air 5 CFM	Voltage	Current Min/Max	Voltage	Current Min/Max	Voltage	Current Min/Max	Voltage	Current Min/Max	
80 W	100 W	+5.0 V	0.0 A/12.0 A	+12.0 V	0.0 A/3.0 A					ECM100UD21*
80 W	100 W	+5.0 V	0.0 A/12.0 A	+15.0 V	0.0 A/3.0 A					ECM100UD22*
75 W	100 W	+5.0 V	0.5 A/10.0 A	+12.0 V	0.0 A/3.0 A	-12.0 V	0.0 A/0.8 A			ECM100UT31*†^
80 W	100 W	+5.0 V	0.5 A/10.0 A	+24.0 V	0.0 A/2.0 A	-12.0 V	0.0 A/0.8 A			ECM100UT32*
80 W	100 W	+5.0 V	0.5 A/10.0 A	+15.0 V	0.0 A/3.0 A	-15.0 V	0.0 A/0.8 A			ECM100UT33*†^
65 W	100 W	+3.3 V	0.5 A/10.0 A	+5.0 V	0.0 A/5.0 A	+12.0 V	0.0 A/0.8 A			ECM100UT34*^
70 W	100 W	+5.0 V	0.5 A/10.0 A	+3.3 V	0.0 A/5.0 A	+12.0 V	0.0 A/0.8 A			ECM100UT35*
80 W	100 W	+5.0 V	0.5 A/10.0 A	+12.0 V	0.0 A/3.0 A	-5.0 V	0.0 A/0.8 A			ECM100UT36*
70 W	100 W	+5.0 V	0.5 A/10.0 A	+15.0 V	0.0 A/3.0 A	-5.0 V	0.0 A/0.8 A			ECM100UT37*
65 W	100 W	+5.0 V	0.5 A/10.0 A	+3.3 V	0.1 A/5.0 A	+12.0 V	0.0 A/0.8 A	-12.0 V	0.0 A/0.5 A	ECM100UQ41*†
60 W	100 W	+3.3 V	0.5 A/10.0 A	+5.0 V	0.1 A/5.0 A	+12.0 V	0.0 A/0.8 A	-12.0 V	0.0 A/0.5 A	ECM100UQ42*†^
80 W	100 W	+5.0 V	0.5 A/10.0 A	+24.0 V	0.1 A/2.0 A	+12.0 V	0.0 A/0.8 A	-12.0 V	0.0 A/0.5 A	ECM100UQ43*†^
80 W	100 W	+5.0 V	0.5 A/10.0 A	+24.0 V	0.1 A/2.0 A	+15.0 V	0.0 A/0.8 A	-15.0 V	0.0 A/0.5 A	ECM100UQ44*†
80 W	100 W	+5.0 V	0.5 A/10.0 A	+12.0 V	0.1 A/3.0 A	-12.0 V	0.0 A/0.8 A	-5.0 V	0.0 A/0.5 A	ECM100UQ45*^
80 W	100 W	+5.0 V	0.5 A/10.0 A	+15.0 V	0.1 A/3.0 A	-15.0 V	0.0 A/0.8 A	-5.0 V	0.0 A/0.5 A	ECM100UQ46*

Notes

- To receive unit with cover fitted, add suffix '-C' to model number.
- Output 3 available with opposite polarity for OEM quantities.
- '*' denotes ECM100 models are class I only, contact sales for class II.
- 48 VDC input version of 12 V single output model available in OEM quantities (DCM10048S12).

† Available from Farnell. ^ Available from Newark. See pages 204-208.

Mechanical Details

Weight: approx.
0.4 lb (180g)

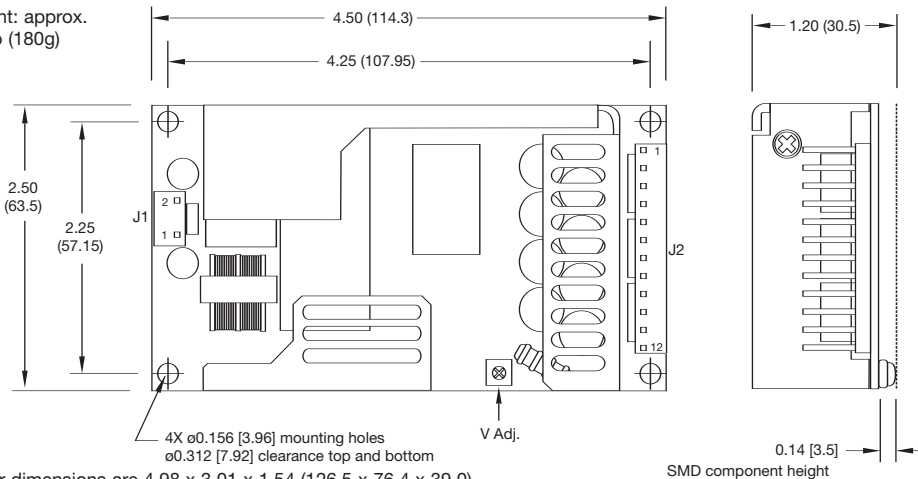

Input Connector J1	
Pin 1	Line
Pin 2	Neutral

J1 mates with Molex housing 43061-0003 and Molex series 5194 crimp terminals. Optional ground (0.25 faston) tab available.

Output Connector J2		
Pin	Single	Multi
1	+V1	+V1
2	+V1	+V1
3	+V1	+V1
4	+V1	+V1
5	V1 RTN	RTN
6	V1 RTN	RTN
7	V1 RTN	RTN
8	V1 RTN	RTN
9	NOT USED	+V2
10	NOT USED	+V2
11	NOT USED	±V3
12	NOT USED	-V4

J2 mates with Molex housing 43061-0012 and Molex series 5194 crimp terminals.

Notes

- All dimensions in inches (mm). Tolerance .xx = ±0.02 (0.50); .xxx = ±0.01 (0.25)
- Cable harness with 300 mm wire available. For single output models, order part number ECM100S LOOM†. For multi-outputs, p/n ECM100DT LOOM†.
- Mating connector kit available for single output models. Order part number ECM100S CONKIT†.
- Covers available. Order part number ECM100 COVER†^.
- Available in a 3" x 5" footprint for OEM quantities. Contact sales for details.

Derating Curves

All ECM100 single output models convection-cooled

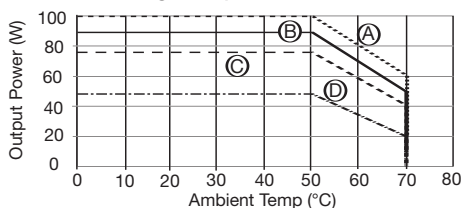

- (A) US24-48
- (B) US12-18
- (C) US05
- (D) US03

Note:

- Derate by 10% if cover is fitted.
- For multi output convection-cooled operation above +50 °C derate linearly to 50% at +70 °C.

All ECM100 models with 5 CFM

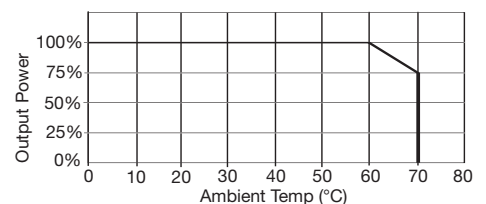

Consult longform datasheet for installation information regarding optimum thermal ratings in convection-cooled applications.