

### Features

- Diffused Junction
- Low Forward Voltage Drop
- High Current Capability
- High Reliability
- High Surge Current Capability
- Ideal for Printed Circuit Boards
-  Recognized File # E157705

### Mechanical Data

- Case: KBL, Molded Plastic
- Terminals: Plated Leads Solderable per MIL-STD-202, Method 208
- Polarity: As Marked on Body
- Weight: 5.6 grams (approx.)
- Mounting Position: Any
- Marking: Type Number
- **Lead Free: For RoHS / Lead Free Version, Add "-LF" Suffix to Part Number, See Page 4**

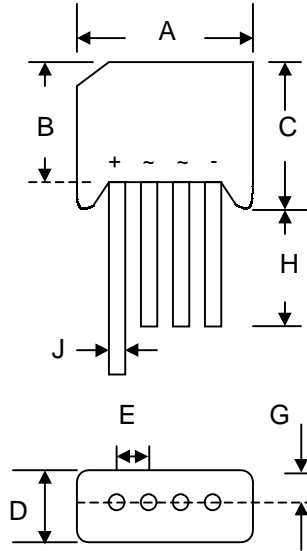

KBL		
Dim	Min	Max
A	18.50	19.50
B	13.70	14.70
C	15.20	16.30
D	6.00	6.50
E	4.60	5.60
G	—	2.10
H	19.00	—
J	1.20 Ø	1.30 Ø
All Dimensions in mm		

### Maximum Ratings and Electrical Characteristics @T<sub>A</sub>=25°C unless otherwise specified

Single Phase, half wave, 60Hz, resistive or inductive load.  
For capacitive load, derate current by 20%.

Characteristic	Symbol	KBL 400	KBL 401	KBL 402	KBL 404	KBL 406	KBL 408	KBL 410	Unit
Peak Repetitive Reverse Voltage Working Peak Reverse Voltage DC Blocking Voltage	V <sub>RRM</sub> V <sub>RWM</sub> V <sub>R</sub>	50	100	200	400	600	800	1000	V
RMS Reverse Voltage	V <sub>R(RMS)</sub>	35	70	140	280	420	560	700	V
Average Rectified Output Current @T <sub>C</sub> = 75°C	I <sub>O</sub>	4.0							A
Non-Repetitive Peak Forward Surge Current 8.3ms Single half sine-wave superimposed on rated load (JEDEC Method)	I <sub>FSM</sub>	150							A
Forward Voltage per leg @I <sub>F</sub> = 2.0A	V <sub>FM</sub>	1.1							V
Peak Reverse Current @T <sub>A</sub> = 25°C At Rated DC Blocking Voltage @T <sub>A</sub> = 125°C	I <sub>R</sub>	5.0 1.0							µA mA
Rating for Fusing (t < 8.3ms) (Note 1)	I <sup>2</sup> <sub>t</sub>	166							A <sup>2</sup> s
Typical Thermal Resistance per leg (Note 2)	R <sub>θJA</sub>	19							°C/W
Typical Thermal Resistance per leg (Note 3)	R <sub>θJL</sub>	2.4							°C/W
Operating and Storage Temperature Range	T <sub>j</sub> , T <sub>STG</sub>	-65 to +150							°C

Note: 1. Non-repetitive for t > 1ms and < 8.3ms.  
2. Mounted on 75 x 75 x 3.0mm Al. plate.  
3. Mounted on PCB at 9.5mm lead length with 12mm<sup>2</sup> copper pad.

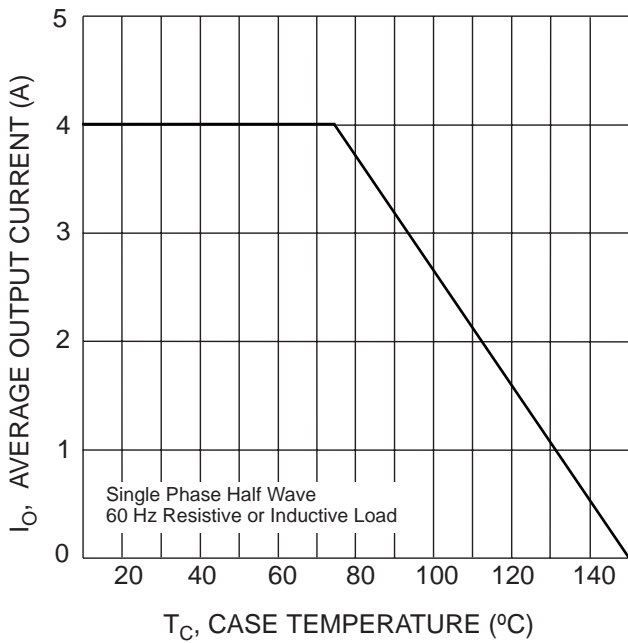

Fig. 1 Forward Current Derating Curve

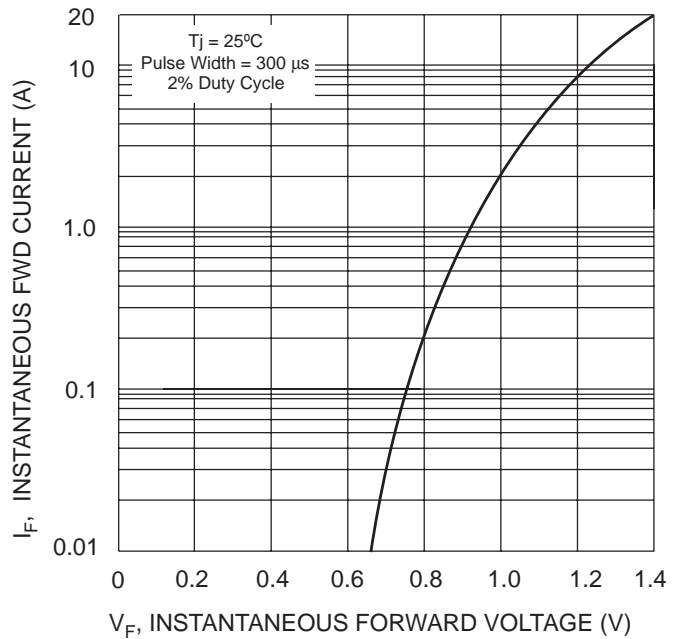

Fig. 2 Typical Forward Characteristics, per element

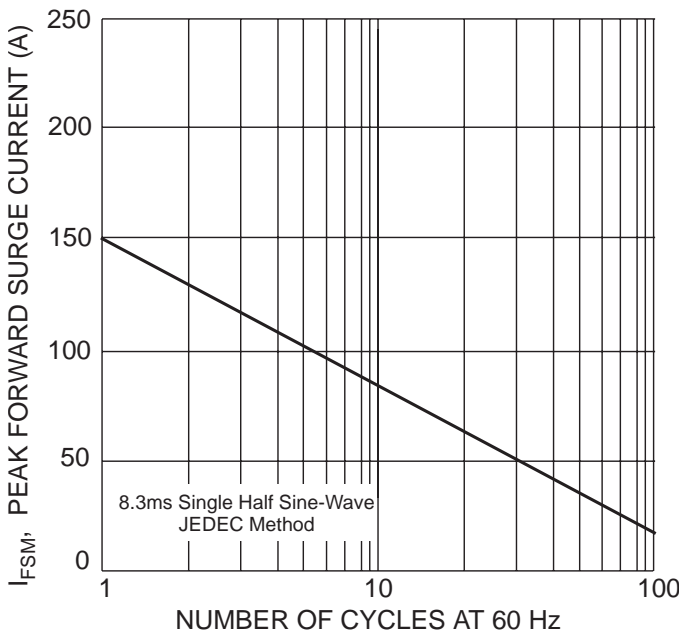

Fig. 3 Max Non-Repetitive Peak Fwd Surge Current

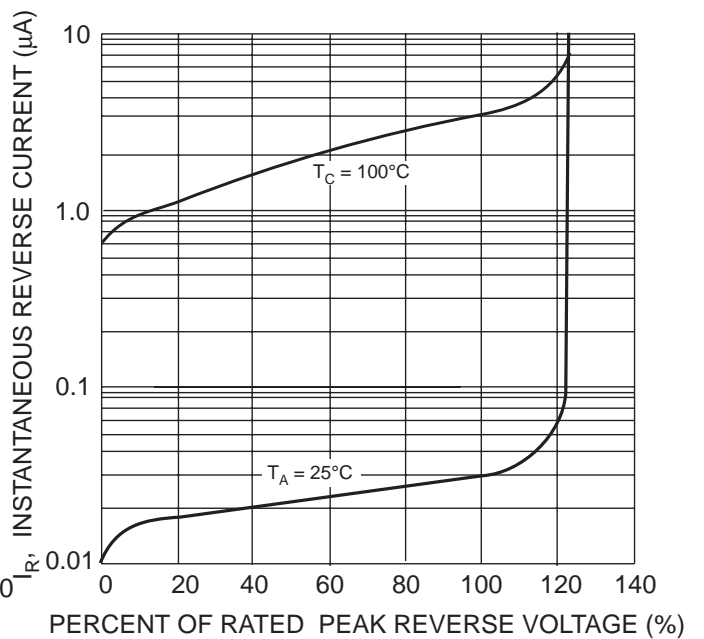
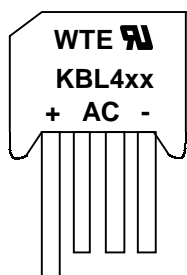

Fig. 4 Typical Reverse Characteristics, per element

## MARKING INFORMATION



WTE = Manufacturer's Logo  
 KBL4xx = Device Number  
 xx = 00, 01, 02, 04, 06, 08 or 10  
 Polarity = As Marked on Body

## PACKAGING INFORMATION

### BULK

Inner Box Size L x W x H (mm)	Quantity (PCS)	Carton Size L x W x H (mm)	Quantity (PCS)	Approx. Gross Weight (KG)
230 x 230 x 50	500	495 x 245 x 180	3,000	19.5

**Note:** 1. Paper box, white or brown color.

## ORDERING INFORMATION

Product No.	Package Type	Shipping Quantity
KBL400	SIL Bridge	500 Units/Box
KBL401	SIL Bridge	500 Units/Box
KBL402	SIL Bridge	500 Units/Box
KBL404	SIL Bridge	500 Units/Box
KBL406	SIL Bridge	500 Units/Box
KBL408	SIL Bridge	500 Units/Box
KBL410	SIL Bridge	500 Units/Box

1. Shipping quantity given is for minimum packing quantity only. For minimum order quantity, please consult the Sales Department.
2. **To order Lead Free version (with Lead Free finish), add "-LF" suffix to part number above. For example, KBL400-LF.**

Won-Top Electronics Co., Ltd (WTE) has checked all information carefully and believes it to be correct and accurate. However, WTE cannot assume any responsibility for inaccuracies. Furthermore, this information does not give the purchaser of semiconductor devices any license under patent rights to manufacturer. WTE reserves the right to change any or all information herein without further notice.

**WARNING:** DO NOT USE IN LIFE SUPPORT EQUIPMENT. WTE power semiconductor products are not authorized for use as critical components in life support devices or systems without the express written approval.

**Won-Top Electronics Co., Ltd.**

No. 44 Yu Kang North 3rd Road, Chine Chen Dist., Kaohsiung, Taiwan

**Phone:** 886-7-822-5408 or 886-7-822-5410

**Fax:** 886-7-822-5417

**Email:** sales@wontop.com

**Internet:** <http://www.wontop.com>

*We power your everyday.*