

## N-Channel 20-V(D-S) MOSFET

V(BR)DSS	RDS(on)MAX	ID
20 V	48mΩ@4.5V	6A
	55mΩ@2.5V	

### FEATURE

※ TrenchFET Power MOSFET

### APPLICATION

- ※ Load Switch for Portable Devices
- ※ DC/DC Converter

### MARKING

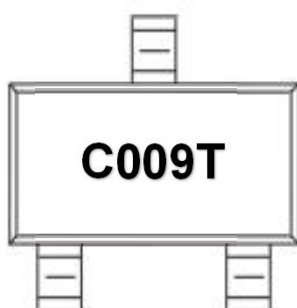

### Equivalent Circuit

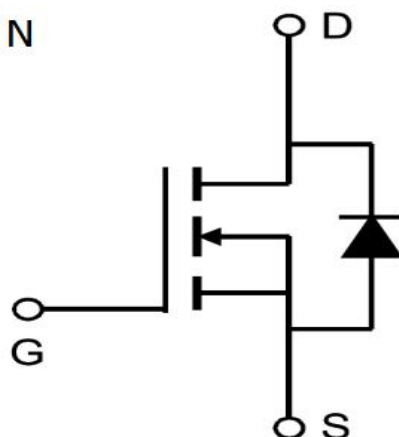

### SOT-23

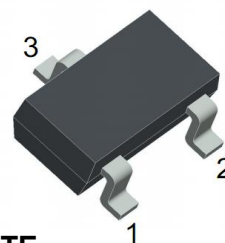

- 1.GATE
- 2.SOURCE
- 3.DRAIN

Maximum ratings ( Ta=25°C unless otherwise noted)

Parameter	Symbol	Value	Unit
Drain-Source Voltage	VDS	20	V
Gate-Source Voltage	VGS	±12	
Continuous Drain Current	ID	6	A
Continuous Source-Drain Current(Diode Conduction)	IS	0.6	
Power Dissipation	PD		W
Thermal Resistance from Junction to Ambient (t≤5s)	RθJA	312.5	°C/W
Operating Junction	TJ	150	°C
Storage Temperature	TSTG	-55~+150	°C

**MOSFET ELECTRICAL CHARACTERISTICS**
**Static Electrical Characteristics (Ta = 25 °C Unless Otherwise Noted)**

Parameter	Symbol	Test Condition	Min	Typ	Max	Unit
<b>Static</b>						
Drain-source breakdown voltage	V(BR)DSS	VGS = 0V, ID =250μA	20			V
Gate-threshold voltage	VGS(th)	VDS =VGS, ID =250μA	0.45		1	V
Gate-body leakage	IGSS	VDS =0V, VGS =±10V			±100	nA
Zero gate voltage drain current	IDSS	VDS =16V, VGS =0V			1	μA
Drain-source on-resistance <sup>a</sup>	RDS(on)	VGS =4.5V, ID = 6A		22	48	mΩ
		VGS =2.5V, ID =4A		28	55	mΩ
Forward transconductance <sup>a</sup>	gfs	VDS =5V, ID =6A		8		S
Diode forward voltage	VSD	IS=1A, VGS=0V		0.74	1.28	V
<b>Dynamic</b>						
Total gate charge	Qg	VDS =10V, VGS =4.5V, ID =6A		7.7	10	nC
Gate-source charge	Qgs			0.32		nC
Gate-drain charge	Qgd			2.1		nC
Input capacitance <sup>b</sup>	Ciss	VDS =10V, VGS =0V, f=1MHz		574		pF
Output capacitance <sup>b</sup>	Coss			70		pF
Reverse transfer capacitance <sup>b</sup>	Crss			60		pF
<b>Switching<sup>b</sup></b>						
Turn-on delay time	td(on)	VDD=10V		78.7		ns
Rise time	tr	RL=5.5Ω, ID ≈3.6A,		128		ns
Turn-off delay time	td(off)	VGEN=4.5V,Rg=6Ω		453		ns
Fall time	tf			80.9		ns

**Note :**

1. Repetitive Rating : Pulse width limited by maximum junction temperature.
2. Surface Mounted on FR4 Board, t < 5 sec.
3. Pulse Test : Pulse Width≤300μs, Duty Cycle ≤ 2%.
4. Guaranteed by design, not subject to production testing.

**TYPICAL ELECTRICAL AND THERMAL CHARACTERISTICS**

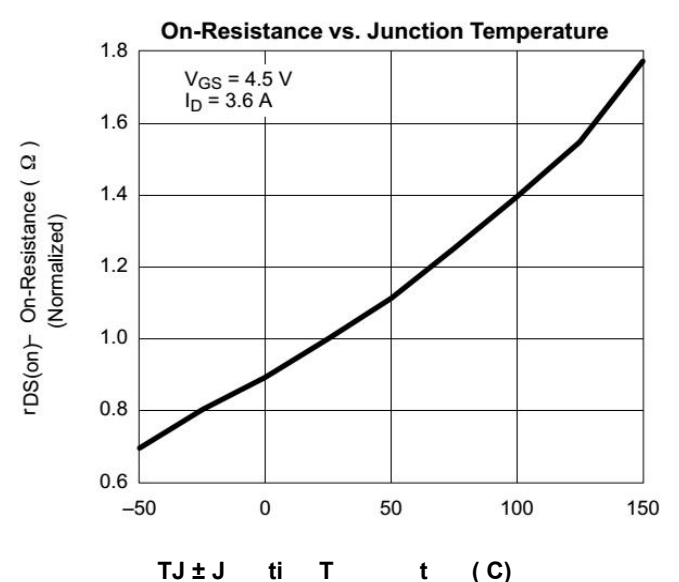
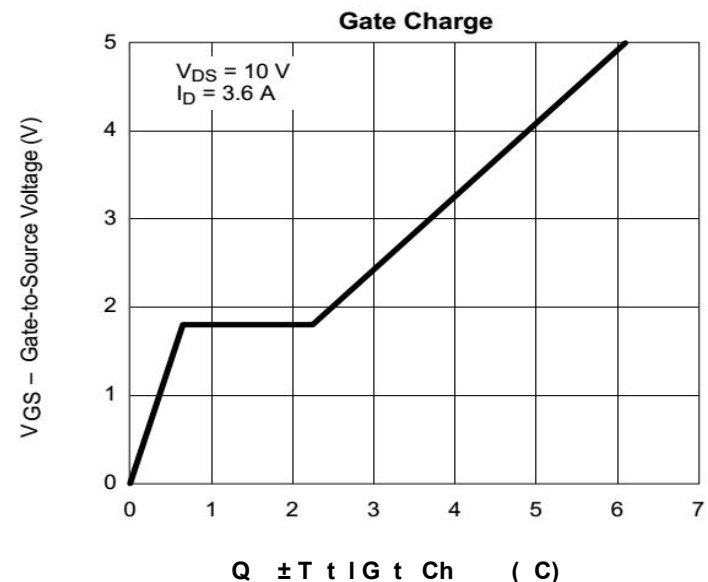
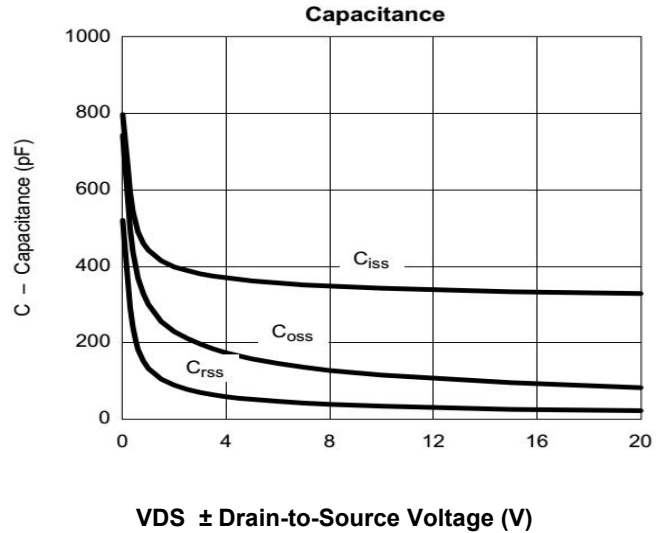
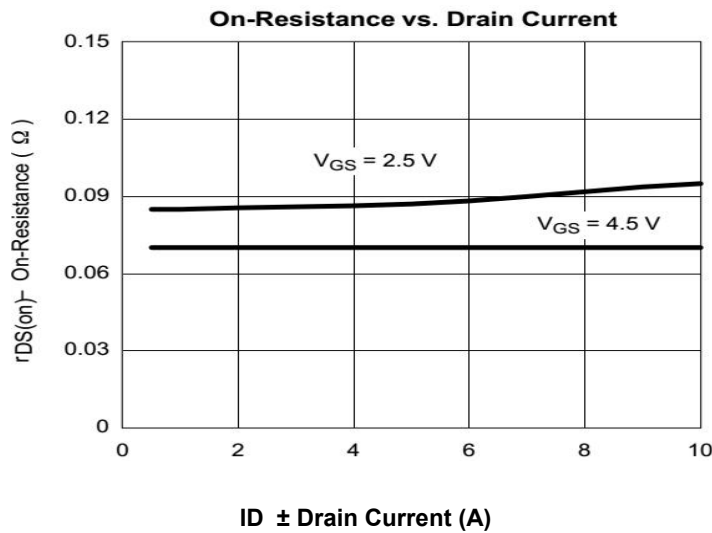
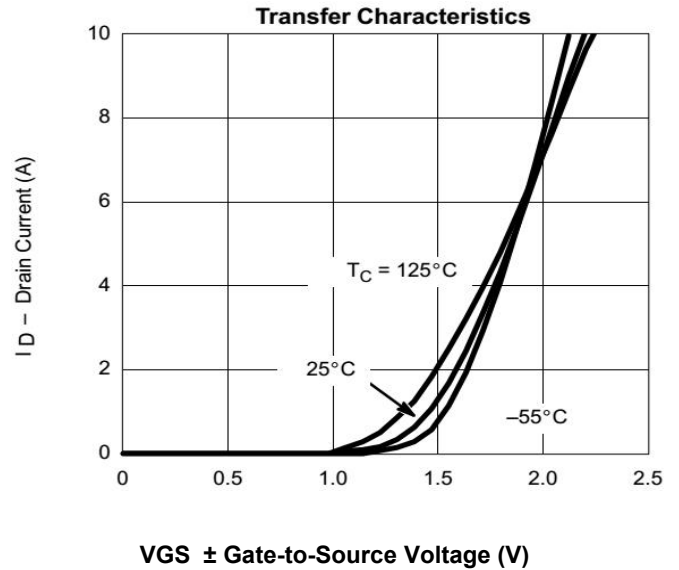
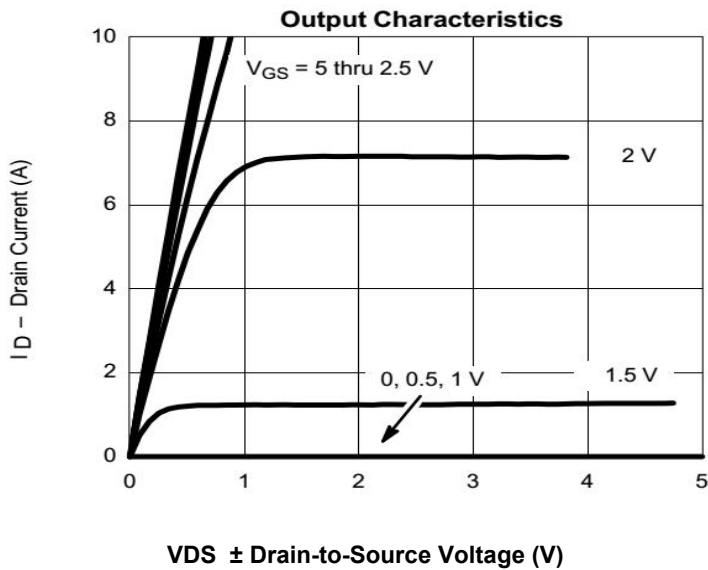

**TYPICAL ELECTRICAL AND THERMAL CHARACTERISTICS**

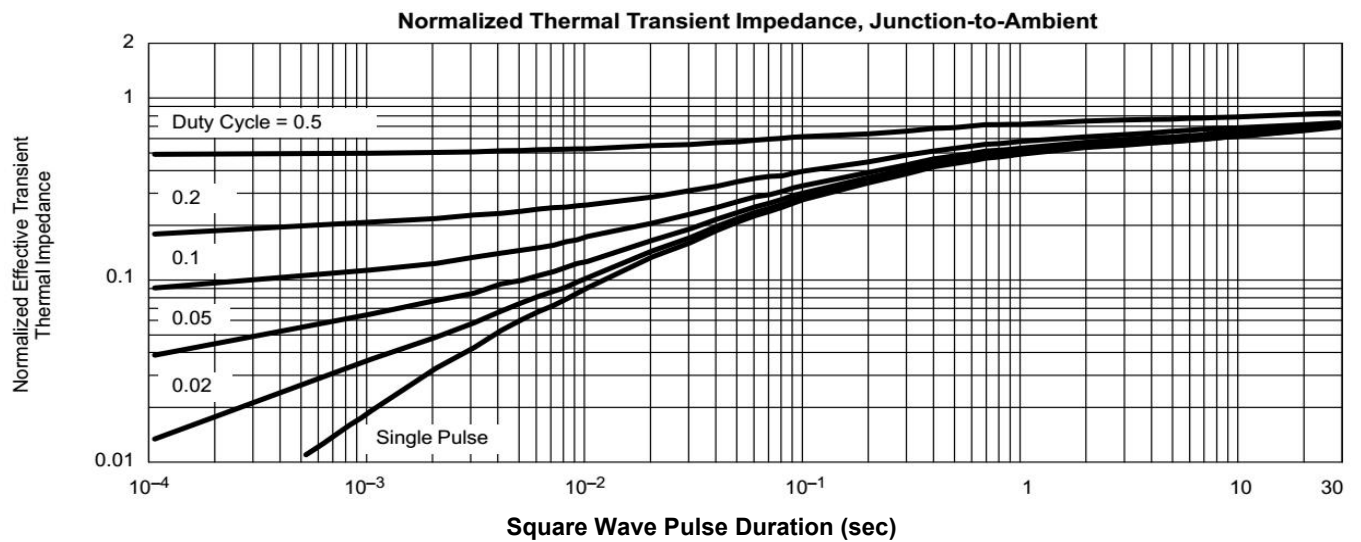
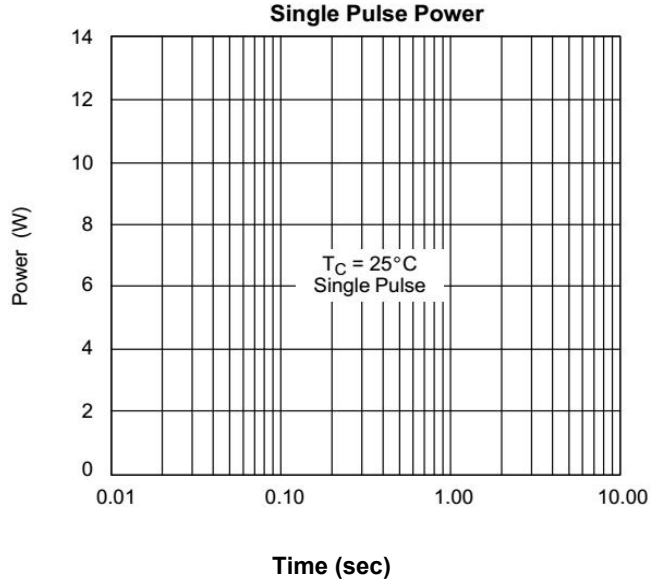
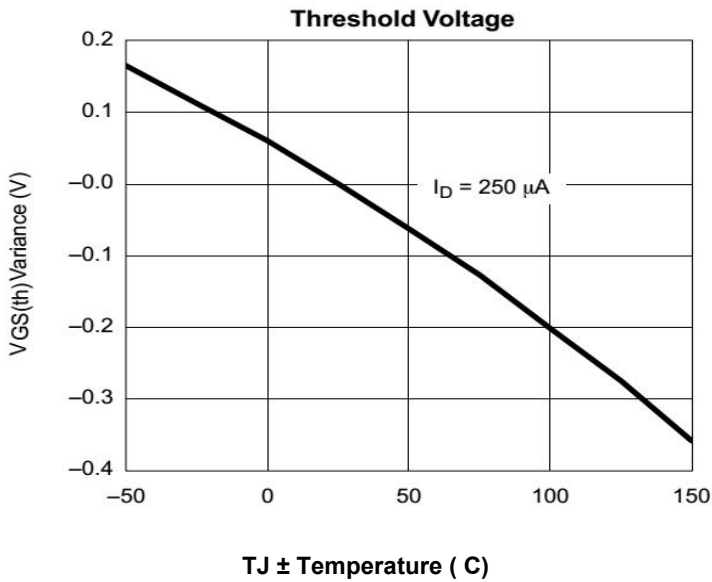
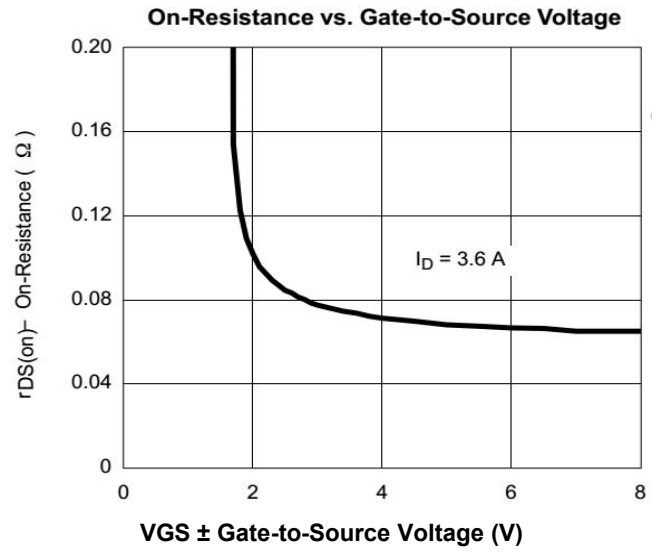
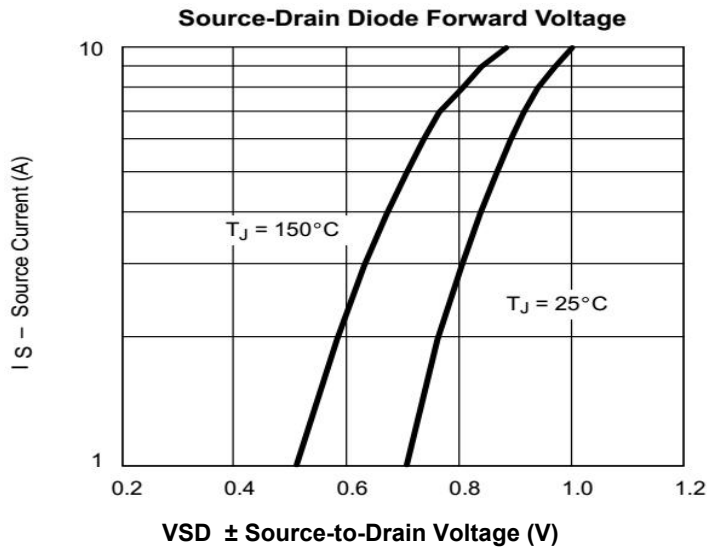

**SOT-23 PACKAGE OUTLINE DIMENSIONS**

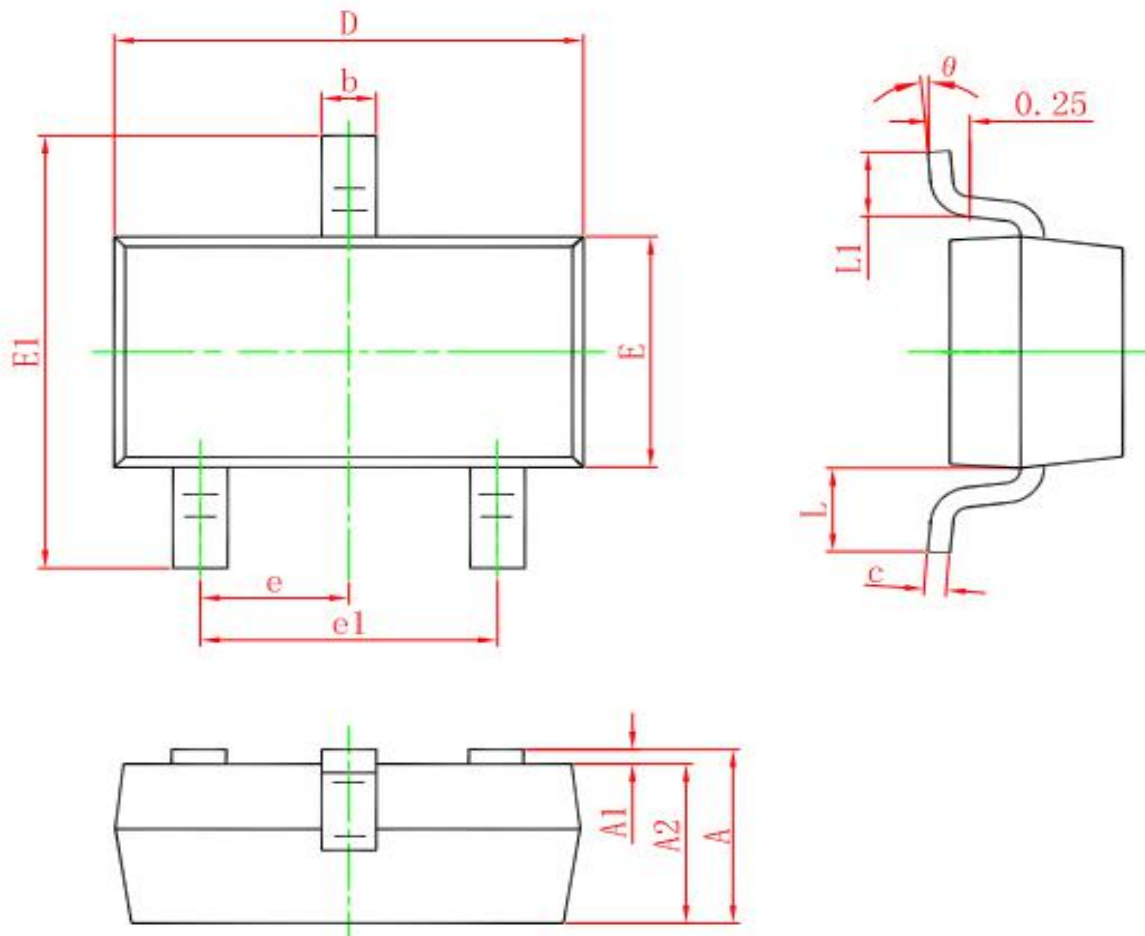

Symbol	Dimensions In Millimeters		Dimensions In Inches	
	Min.	Max.	Min.	Max.
A	0.900	1.150	0.035	0.045
A1	0.000	0.100	0.000	0.004
A2	0.900	1.050	0.035	0.041
b	0.300	0.500	0.012	0.020
c	0.080	0.150	0.003	0.006
D	2.800	3.000	0.110	0.118
E	1.200	1.400	0.047	0.055
E1	2.250	2.550	0.089	0.100
e	0.950 TYP.		0.037 TYP.	
e1	1.800	2.000	0.071	0.079
L	0.550 REF.		0.022 REF.	
L1	0.300	0.500	0.012	0.020
$\theta$	0°	8°	0°	8°