

Specifications

Insulation Resistance: 1,000MΩ min.
 Withstanding Voltage: 1,500V ACrms for 1 minute
 Contact Resistance: 10mΩ
 Voltage Rating: 250V AC/DC
 Current Rating: 5A AC/DC
 Operating Temp. Range: -25°C to +105°C

Materials and Finish

Insulator: Nylon46, UL94V-0 rated
 Contact: Brass, Tin Plated

Features

- For wire-to-wire and wire-to-board applications
- Fully insulated terminals
- Low engagement terminals
- Locking function

Part Number (Details)

P3BP - 12 S - T* - LL - T

Series

Pin Count

S = Single Row
 # of contacts (2 to 12)

T1 = 180° TH T9 = 90° TH

Mating / Termination Area:
 LL = Tin / Tin

T = Tube Packaging

Outline Dimensions 90° Single Row

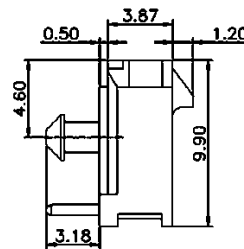
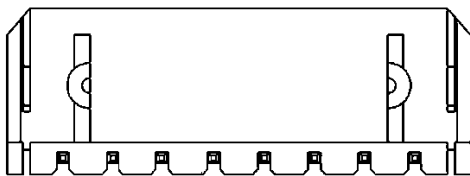
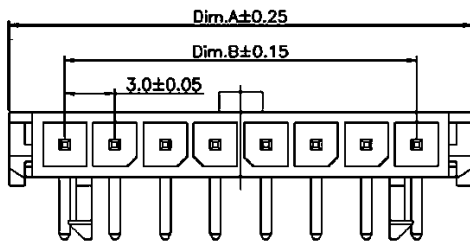

PCB Layout

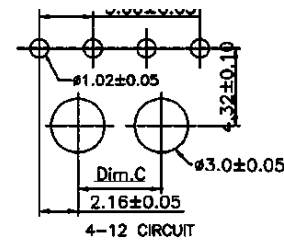
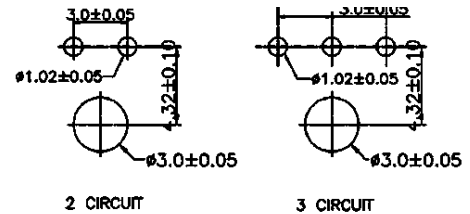

Outline Dimensions 180° Single Row

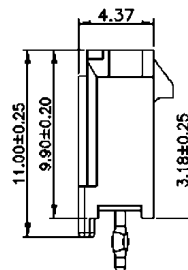
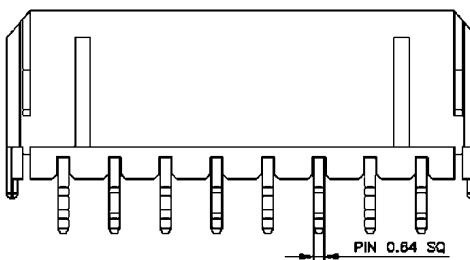
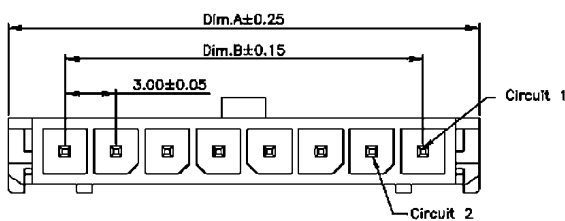

PCB Layout

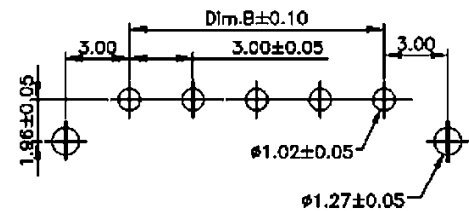

Part Number	Pin Count	A	B	C
P3BP-2S-T*-LL-T	2	9.65	3.00	-
P3BP-3S-T*-LL-T	3	12.65	6.00	-
P3BP-4S-T*-LL-T	4	15.65	9.00	4.70
P3BP-5S-T*-LL-T	5	18.65	12.00	7.70
P3BP-6S-T*-LL-T	6	21.65	15.00	10.70
P3BP-7S-T*-LL-T	7	24.65	18.00	10.70

Part Number	No. of Leads	A	B	C
P3BP-8S-T*-LL-T	8	27.65	21.00	16.70
P3BP-9S-T*-LL-T	9	30.65	24.00	19.70
P3BP-10S-T*-LL-T	10	33.65	27.00	22.70
P3BP-11S-T*-LL-T	11	36.65	30.00	27.70
P3BP-12S-T*-LL-T	12	39.65	33.00	28.70

Series BoardFit3.0 - Power Connectors

180° and 90° Male Header 3.00mm Pitch (Dual Row) TH

Internal Connectors

Specifications

Insulation Resistance: 1,000MΩ min.
 Withstanding Voltage: 1,500V ACrms for 1 minute
 Contact Resistance: 10mΩ
 Voltage Rating: 250V AC/DC
 Current Rating: 5A AC/DC
 Operating Temp. Range: -25°C to +105°C

Materials and Finish

Insulator: Nylon46, UL94V-0 rated
 Contact: Brass, Tin Plated

Features

- For wire-to-wire and wire-to-board applications
- Fully insulated terminals
- Low engagement terminals
- Locking function

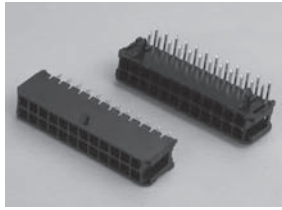

Part Number (Details)

P3BP - 24 D - T* - LL - T

Series

Pin Count

D = Dual Row
of contacts (2 to 24)

T1 = 180° TH T9 = 90° TH

Plating: Mating / Termination Area
LL = Tin / Tin

T = Tube Packaging

Outline Dimensions 90° Dual Row

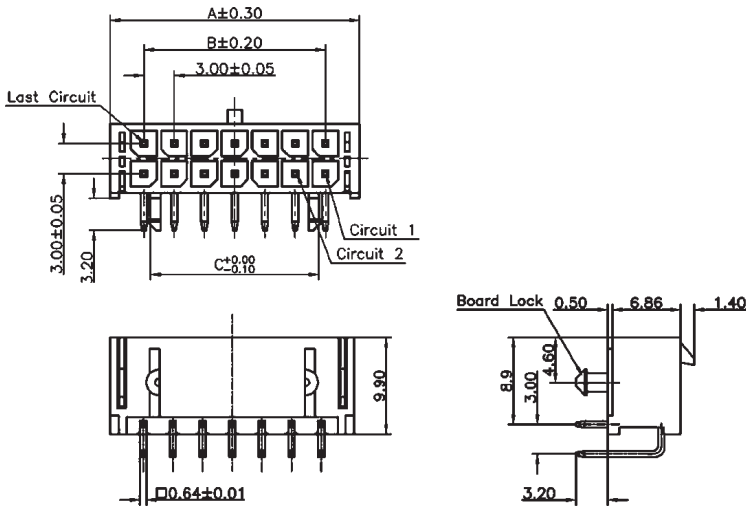

PCB Layout

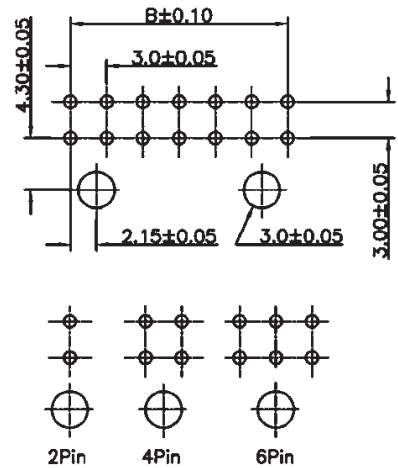

Outline Dimensions 180° Dual Row

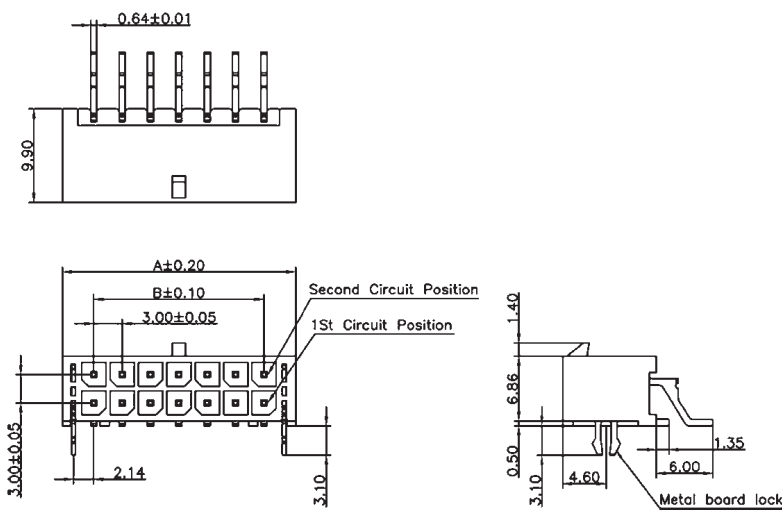

PCB Layout

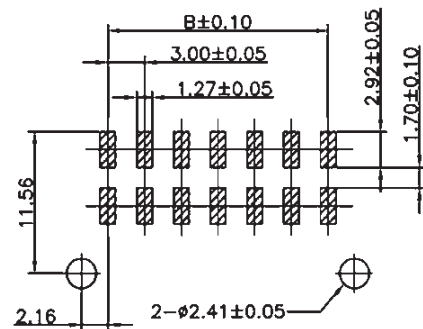

B-t-B and B-t-C, Power Connectors

Part Number	Pin Count	A	B	C
P3BP-2D-T*-LL-T	2	6.70	-	2.70
P3BP-4D-T*-LL-T	4	9.70	3.00	3.00
P3BP-6D-T*-LL-T	6	12.70	6.00	3.00
P3BP-8D-T*-LL-T	8	15.70	9.00	7.70
P3BP-10D-T*-LL-T	10	18.70	12.00	10.70
P3BP-12D-T*-LL-T	12	21.70	15.00	13.70

Part Number	Pin Count	A	B	C
P3BP-14D-T*-LL-T	14	24.70	18.00	16.70
P3BP-16D-T*-LL-T	16	27.70	21.00	19.70
P3BP-18D-T*-LL-T	18	30.70	24.00	22.70
P3BP-20D-T*-LL-T	20	33.70	27.00	25.70
P3BP-22D-T*-LL-T	22	36.70	30.00	28.70
P3BP-24D-T*-LL-T	24	39.70	33.00	31.70

Specifications

Insulation Resistance: 1,000MΩ min.
 Withstanding Voltage: 1,500V ACrms for 1 minute
 Contact Resistance: 10mΩ
 Voltage Rating: 250V AC/DC
 Current Rating: 5A AC/DC
 Operating Temp. Range: -25°C to +105°C

Materials and Finish

Insulator: Nylon46, UL94V-0 rated
 Contact: Brass, Tin Plated

Features

- For wire-to-wire and wire-to-board applications
- Fully insulated terminals
- Low engagement terminals
- Locking function

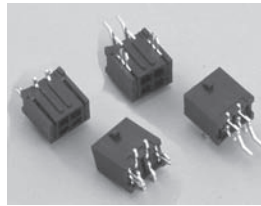

Part Number (Details)

P3BP - 24 D - S* - LL - T

Series	P3BP
Pin Count	24
D = Dual Row # of contacts (2 to 24)	D
S1 = 180° SMT S9 = 90° SMT	S*
Mating / Termination Area: LL = Tin / Tin	LL
T = Tube Packaging	T

Outline Dimensions 90° Dual Row

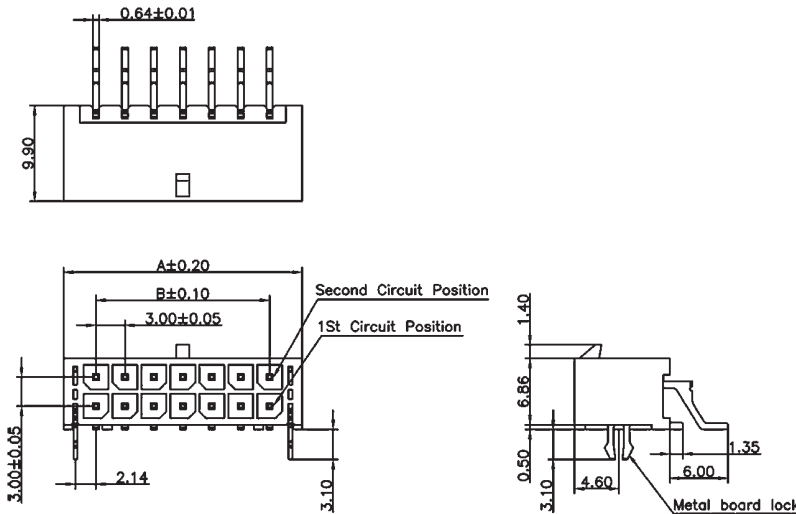

PCB Layout

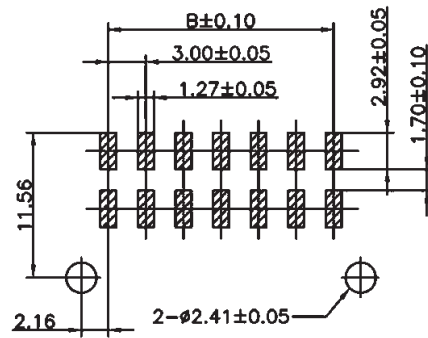

Outline Dimensions 180° Dual Row

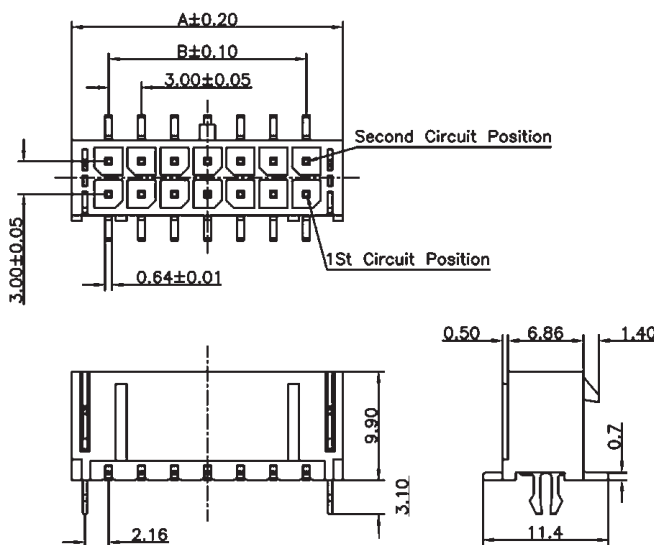

PCB Layout

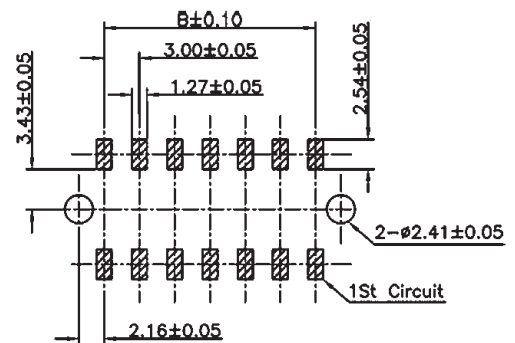

Part Number	Pin Count	A	B
P3BP-2D-S*-LL-T	2	6.70	-
P3BP-4D-S*-LL-T	4	9.70	3.00
P3BP-6D-S*-LL-T	6	12.70	6.00
P3BP-8D-S*-LL-T	8	15.70	9.00
P3BP-10D-S*-LL-T	10	18.70	12.00
P3BP-12D-S*-LL-T	12	21.70	15.00

Part Number	Pin Count	A	B
P3BP-14D-S*-LL-T	14	24.70	18.00
P3BP-16D-S*-LL-T	16	27.70	21.00
P3BP-18D-S*-LL-T	18	30.70	24.00
P3BP-20D-S*-LL-T	20	33.70	27.00
P3BP-22D-S*-LL-T	22	36.70	30.00
P3BP-24D-S*-LL-T	24	39.70	33.00

Series BoardFit3.0 - Power Connectors 180° Male Cable Power Connector 3.00mm Pitch (Single & Dual Row)

Specifications

Insulation Resistance: 1,000MΩ min.
 Withstanding Voltage: 1,500V ACrms for 1 minute
 Contact Resistance: 20mΩ (single row)
 10mΩ (dual row)

Voltage Rating: 250V AC/DC
 Current Rating: 5A AC/DC
 Operating Temp. Range: -25°C to +105°C

Materials and Finish

Insulator: Nylon66, UL94V-0 rated
 Contact: Phosphor Bronze, Tin Plated
 Crimp Terminal: Phosphor Bronze, Tin Plated

Features

- For wire-to-wire and wire-to-board applications
- Fully insulated terminals
- Low engagement terminals
- Locking function



Part Number (Details)

P3CP - 12 * - C1 - LL - B

Series

Pin Count

S = Single Row (2 to 12)
 D = Dual Row (2 to 24)

C1 = 180° Crimp

Plating: Mating / Termination Area
 LL = Tin / Tin

B = Bulk Packaging

Part Number for Crimp Contacts

P3CP-Contact (wire gauge = AWG 20-24)

Outline Dimensions 180° Single Row

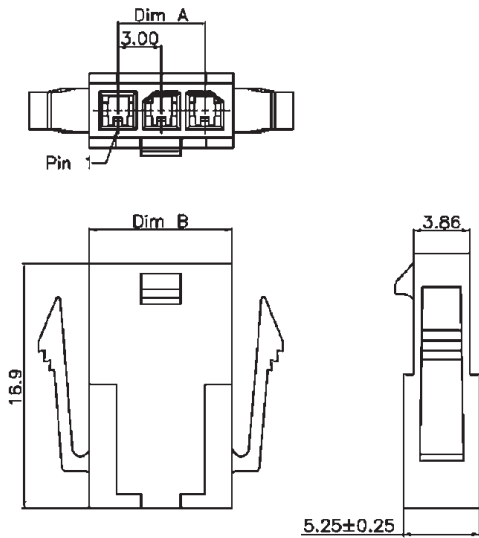

Outline Dimensions 180° Dual Row

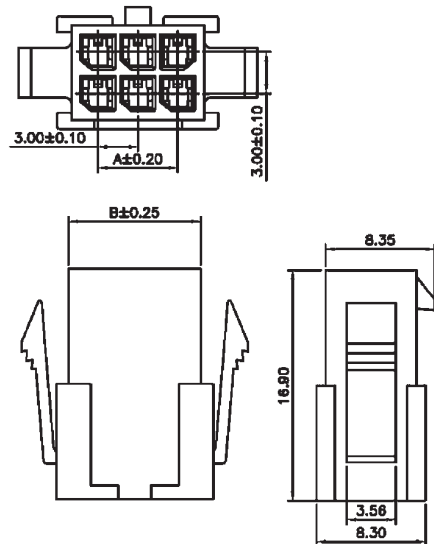

Outline Dimensions Crimp Contacts

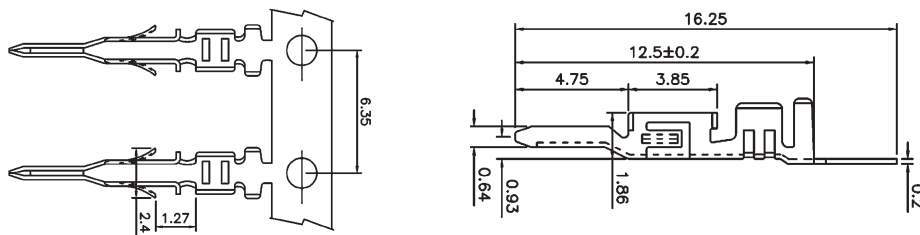

Single Row

Part Number	Pin Count	A	B
P3CP-2S-C1-LL-B	2	3.00	6.85
P3CP-3S-C1-LL-B	3	6.00	9.85
P3CP-4S-C1-LL-B	4	9.00	12.85
P3CP-5S-C1-LL-B	5	12.00	15.85
P3CP-6S-C1-LL-B	6	15.00	18.85
P3CP-7S-C1-LL-B	7	18.00	21.85
P3CP-8S-C1-LL-B	8	21.00	24.85
P3CP-9S-C1-LL-B	9	24.00	27.85
P3CP-10S-C1-LL-B	10	27.00	30.85
P3CP-11S-C1-LL-B	11	30.00	33.85
P3CP-12S-C1-LL-B	12	33.00	36.85

Dual Row

Part Number	Pin Count	A	B
P3CP-2D-C1-LL-B	2	-	3.85
P3CP-4D-C1-LL-B	4	3.00	6.85
P3CP-6D-C1-LL-B	6	6.00	9.85
P3CP-8D-C1-LL-B	8	9.00	12.85
P3CP-10D-C1-LL-B	10	12.00	15.85
P3CP-12D-C1-LL-B	12	15.00	18.85
P3CP-14D-C1-LL-B	14	18.00	21.85
P3CP-16D-C1-LL-B	16	21.00	24.85
P3CP-18D-C1-LL-B	18	24.00	27.85
P3CP-20D-C1-LL-B	20	27.00	30.85
P3CP-22D-C1-LL-B	22	30.00	33.85
P3CP-24D-C1-LL-B	24	33.00	36.85

B-t-B and B-t-C, Power Connectors

Specifications

Insulation Resistance: 1,000MΩ min.
 Withstanding Voltage: 1,500V ACrms for 1 minute
 Contact Resistance: 20mΩ (single row)
 10mΩ (dual row)

Voltage Rating: 250V AC/DC
 Current Rating: 5A AC/DC
 Operating Temp. Range: -25°C to +105°C

Materials and Finish

Insulator: Nylon66, UL94V-0 rated
 Contact: Single (Brass, Tin Plated)
 Dual (Phosphor Bronze, Tin Plated)
 Crimp Terminal: Phosphor Bronze, Tin Plated

Features

- For wire-to-wire and wire-to-board applications
- Fully insulated terminals
- Low engagement terminals
- Locking function



Part Number (Details)

P3CS - 12 * - C1 - LL - B

Series

Pin Count

S = Single Row (2 to 12)

D = Dual Row (2 to 24)

C1 = 180° Crimp

Plating: Mating / Termination Area

LL = Tin / Tin

B = Bulk Packaging

Part Number for Crimp Contacts

P3CS-Contact (wire gauge = AWG 20-24)

Outline Dimensions 180° Single Row

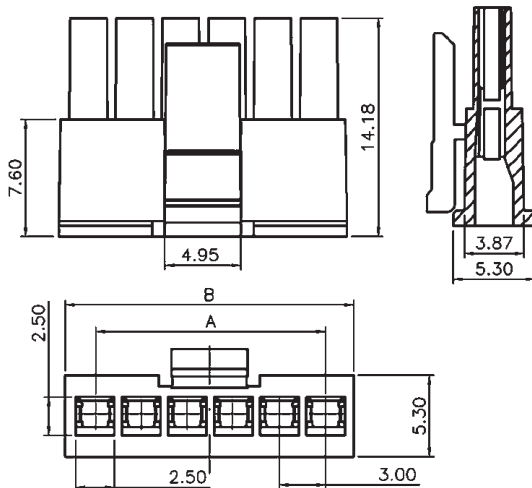

Outline Dimensions 180° Dual Row

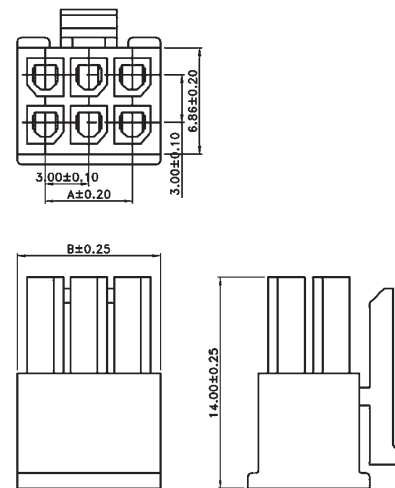

Outline Dimensions Crimp Contacts

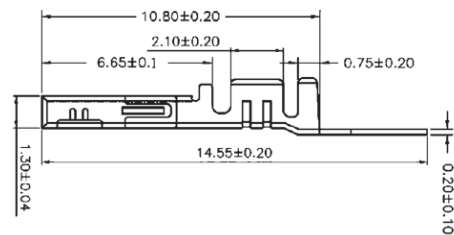
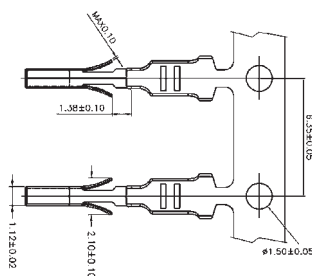

Single Row

Part Number	Pin Count	A	B
P3CS-2S-C1-LL-B	2	3.00	6.85
P3CS-3S-C1-LL-B	3	6.00	9.85
P3CS-4S-C1-LL-B	4	9.00	12.85
P3CS-5S-C1-LL-B	5	12.00	15.85
P3CS-6S-C1-LL-B	6	15.00	18.85
P3CS-7S-C1-LL-B	7	18.00	21.85
P3CS-8S-C1-LL-B	8	21.00	24.85
P3CS-9S-C1-LL-B	9	24.00	27.85
P3CS-10S-C1-LL-B	10	27.00	30.85
P3CS-11S-C1-LL-B	11	30.00	33.85
P3CS-12S-C1-LL-B	12	33.00	36.85

Dual Row

Part Number	Pin Count	A	B
P3CS-2D-C1-LL-B	2	-	3.85
P3CS-4D-C1-LL-B	4	3.00	6.85
P3CS-6D-C1-LL-B	6	6.00	9.85
P3CS-8D-C1-LL-B	8	9.00	12.85
P3CS-10D-C1-LL-B	10	12.00	15.85
P3CS-12D-C1-LL-B	12	15.00	18.85
P3CS-14D-C1-LL-B	14	18.00	21.85
P3CS-16D-C1-LL-B	16	21.00	24.85
P3CS-18D-C1-LL-B	18	24.00	27.85
P3CS-20D-C1-LL-B	20	27.00	30.85
P3CS-22D-C1-LL-B	22	30.00	33.85
P3CS-24D-C1-LL-B	24	33.00	36.85