

## PRODUCT SPECIFICATION

# HDM2432L-T-xxTF

240x320 GRAPHICS  
LCD DISPLAY MODULE  
(LANDSCAPE)

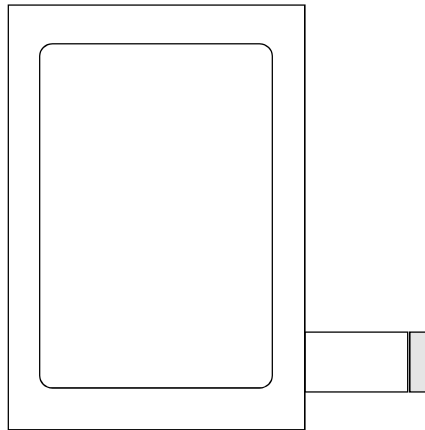

<b>HANTRONIX, INC.</b> 10080 BUBB RD. CUPERTINO, CA 95014	Q.A.: JK	REV.: 1.1	HDM2432L-T-xxTF	SHEET 1 OF 17
				DATE: 7/22/02

# 1. MECHANICAL DATA

(1) Product No.	HDM2432L-T-xxTF
(2) Module Size	MAX.71.3 (W)mm X 93.9 (H)mm X MAX.7.9 (D)mm
(3) Dot Size	0.225 (W)mm X 0.225 (H)mm
(4) Dot Pitch	0.24 (W)mm X 0.24 (H)mm
(5) Number of Dots	240 (W)Dots X 320 (H) Dots
(6) Duty	1/240
(7) LCD Display Mode	FSTN: Normally White Rear Polarizer: Transflective (Normal)
(8) Viewing Direction	9 O'clock
(9) Backlight	LED B/L
(10) Weight	57.0 g (Approx.)
(11) Controller	Excluded
(12) DC/DC Converter	Excluded

<b>HANTRONIX, INC.</b> 10080 BUBB RD. CUPERTINO, CA 95014	Q.A.:	REV.:	<b>HDM2432L-T-xxTF</b>	SHEET 2 OF 17
	JK	1.1		DATE: 7/22/02



### 3. ELECTRICAL CHARACTERISTICS

( VDD= 3.3V ± 5% )

ITEM	SYMBOL	CONDITION	MIN.	TYP.	MAX.	UNIT	
Input Voltage	V <sub>IH</sub>	H level	0.8VDD	—	VDD	V	
	V <sub>IO</sub>	L level	0	—	0.2VDD	V	
Recommended LC Driving Voltage	VLCD-VSS (V <sub>op</sub> )	1/240 Duty 1/13 Bias	-20°C	24.6	24.9	25.2	v
			0°C	23.2	23.5	23.8	
			25°C	22.4	22.7	23.0	
			50°C	21.4	21.7	22.0	
			70°C	20.8	21.1	21.4	
Power Supply Current	I <sub>DD</sub>	VDD=3.3V VSS=0V VLCD-VSS=22.7V FLM=70Hz PATTERN: □ ■ □ ■ □ ■ ■ □ ■ □ ■ □	—	8.4	12.8	mA	
	I <sub>EE</sub>		—	2.6	3.9		
Power Supply Current For LED	I <sub>LED</sub>	VBL=5.0V RBL=33Ω	—	55	82	mA	
LCM	Surface Luminance	L	VDD= 3.3V VSS= 0V VLCD-VSS=22.7V I <sub>LED</sub> =55mA	PATTERN: (Dots All On) ■ ■ ■ ■ ■ ■ ■ ■	—	1.54	cd/m <sup>2</sup>
				PATTERN: (Dots All Off) □ □ □ □ □ □ □ □	—	5.255	

# 4.OPTICAL CHARACTERISTICS

AT V<sub>op</sub>

ITEM		Cr(Contrast Ratio)										θ(Viewing Angle)		θ(Viewing Angle)	
		-20℃		0℃		25℃		50℃		70℃		25℃		25℃	
MODE		MIN.	TYP.	MIN.	TYP.	MIN.	TYP.	MIN.	TYP.	MIN.	TYP.	MIN.	TYP.	MIN.	TYP.
S	P	4.0	6.0	5.5	7.5	5.0	7.0	4.0	6.0	3.0	4.5	-	61	-	(L) 40 (R) 26
Note		NOTE 6										NOTE 5			

NOTE :

S: TRANSFLECTIVE  
P: NORMALLY WHITE 9 O'CLOCK

AT θ=0° θ=0°

ITEM	SYMBOL	CONDITION	MIN.	TYP.	MAX.	UNIT	NOTE
Response Time (rise)	Tr	-20℃	4000	5000	6000	ms	NOTE 2
		0℃	900	1100	1300		
		25℃	240	300	360		
		50℃	120	150	180		
		70℃	100	130	160		
Response Time (fall)	Tf	-20℃	1600	2000	2400	ms	NOTE 2
		0℃	300	370	440		
		25℃	100	130	160		
		50℃	50	65	80		
		70℃	40	50	60		

<b>HANTRONIX, INC.</b> 10080 BUBB RD. CUPERTINO, CA 95014	Q.A.:	REV.:	<b>HDM2432L-T-xxTF</b>	SHEET 5 OF 17
	JK	1.1		DATE:

(NOTE 1)

Definition of Operation Voltage(Vop)

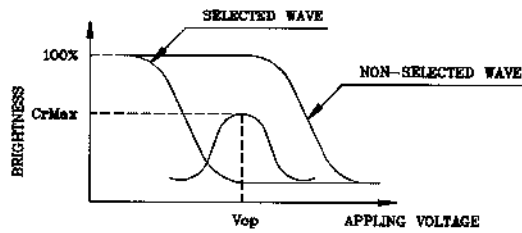

(positive type)

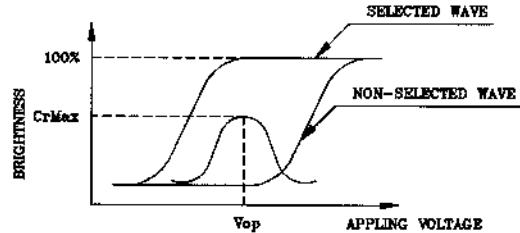

(negative type)

\*Conditions

- Viewing Angle : 0
- Frame Frequency : 70Hz
- Applying Waveform : 1/N duty 1/a bias

(NOTE 2)

Definition of Response Time(Tr,Tf)

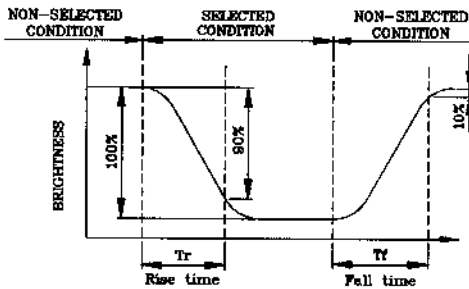

(positive type)

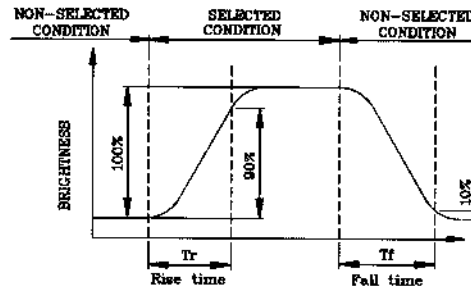

(negative type)

\*Conditions

- Operating Voltage : Vop
- Viewing Angle (θ,φ) : (0,0)
- Frame Frequency : 70Hz
- Applying Waveform : 1/N duty 1/a bias

(NOTE 3)

Description of Measuring Equipment and Driving Waveforms

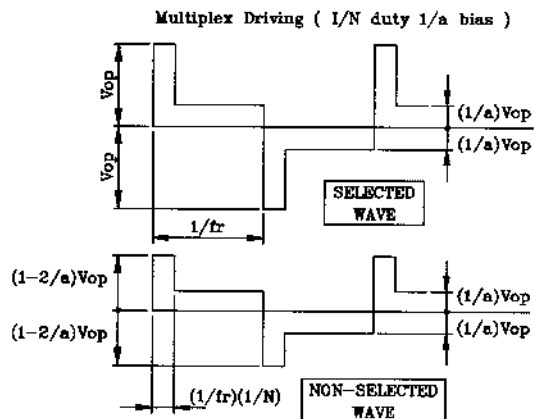
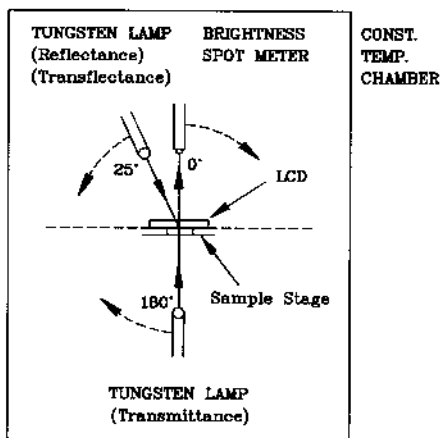

(NOTE 4)

Definition of Viewing Direction

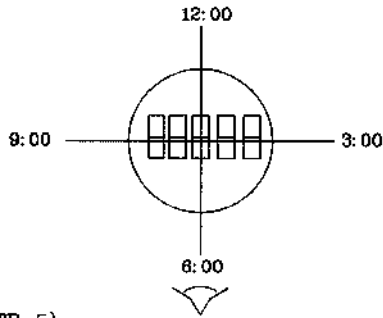

(NOTE 5)

Definition of Viewing Angle

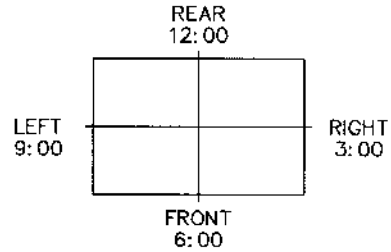
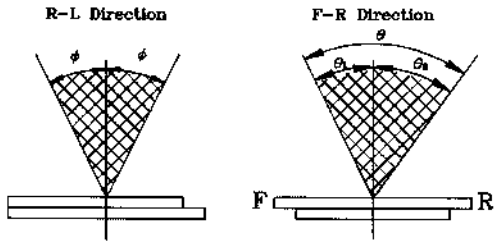

\*For This Product  
The Viewing Direction is 6 O'clock  
So  $\theta_1 > \theta_2$

$$\theta = \theta_1 + \theta_2$$

\*Conditions

Operating Voltage :  $V_{op}$   
Frame Frequency : 70Hz  
Applying Waveform : 1/N duty 1/a bias  
Contrast Ratio : larger than 2

(NOTE 6)

Definition of Contrast Ratio (Cr)

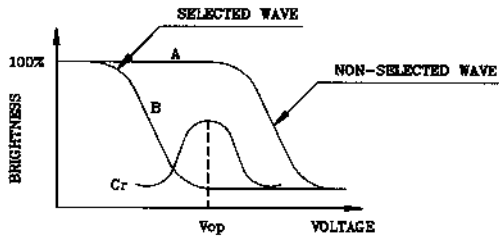

(positive type)

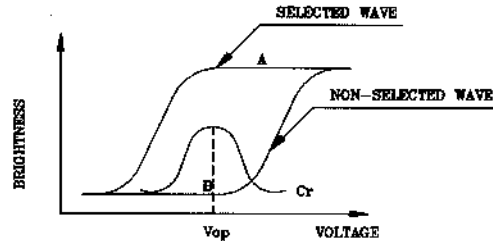

(negative type)

$$\text{Contrast Ratio : } Cr = A/B$$

\*Conditions

Viewing Angle : 0  
Frame Frequency : 70Hz  
Applying Waveform : 1/N duty 1/a bias

<b>HANTRONIX, INC.</b> 10080 BUBB RD. CUPERTINO, CA 95014	Q.A.:	REV.:	<b>HDM2432L-T-xxTF</b>	SHEET 7 OF 17
	JK	1.1		DATE:

# 5. BLOCK DIAGRAM

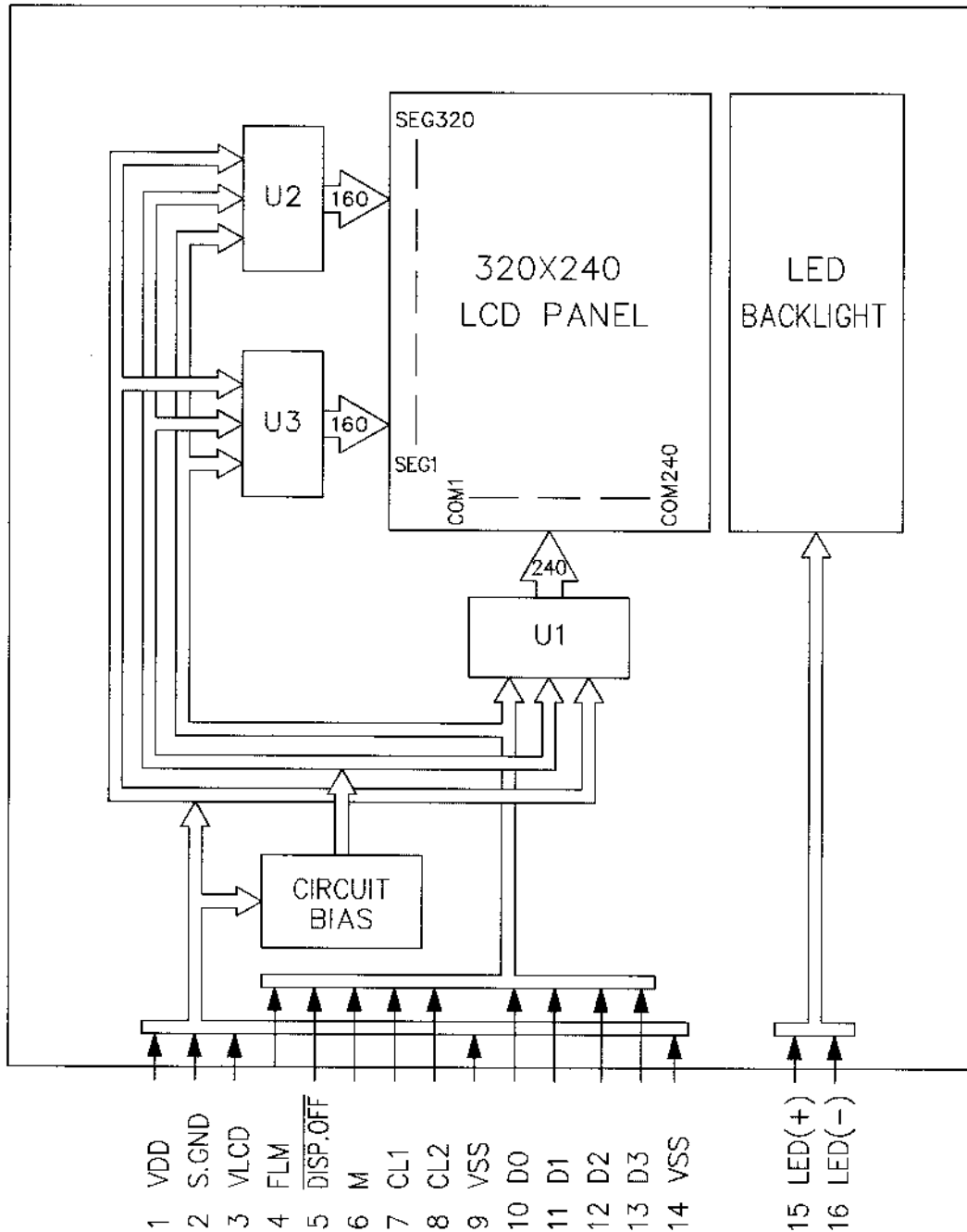



## 6. INTERNAL PIN CONNECTION

FPC, 20 pins, pitch 1.0 mm

Pin No.	Symbol	Function
1	VDD	POWER SUPPLY FOR LOGIC
2	S.GND	SHIELD GROUND
3	VLCD	POWER SUPPLY FOR LCD
4	FLM	FIRST LINE MARKER
5	DISP.OFF	H: ON/L: OFF
6	M	SWITCH SIGNAL TO CONVERT LIQUID CRYSTAL DRIVE WAVEFORM INTO AC
7	CL1	DATA LATCH
8	CL2	SHIFT CLOCK
9	VSS	LOGIC GROUND
10	D0	DISPLAY DATA
11	D1	DISPLAY DATA
12	D2	DISPLAY DATA
13	D3	DISPLAY DATA
14	VSS	LOGIC GROUND
15	LED(+)	POWER SUPPLY FOR LED
16	LED(-)	POWER SUPPLY FOR LED
17	NC	NC
18	NC	NC
19	NC	NC
20	NC	NC

Mating Connector: MOLEX 52271-2090

<b>HANTRONIX, INC.</b> 10080 BUBB RD. CUPERTINO, CA 95014	Q.A.:	REV.:	<b>HDM2432L-T-xxTF</b>	SHEET 9 OF 17
	JK	1.1		DATE:

# 7. POWER SUPPLY

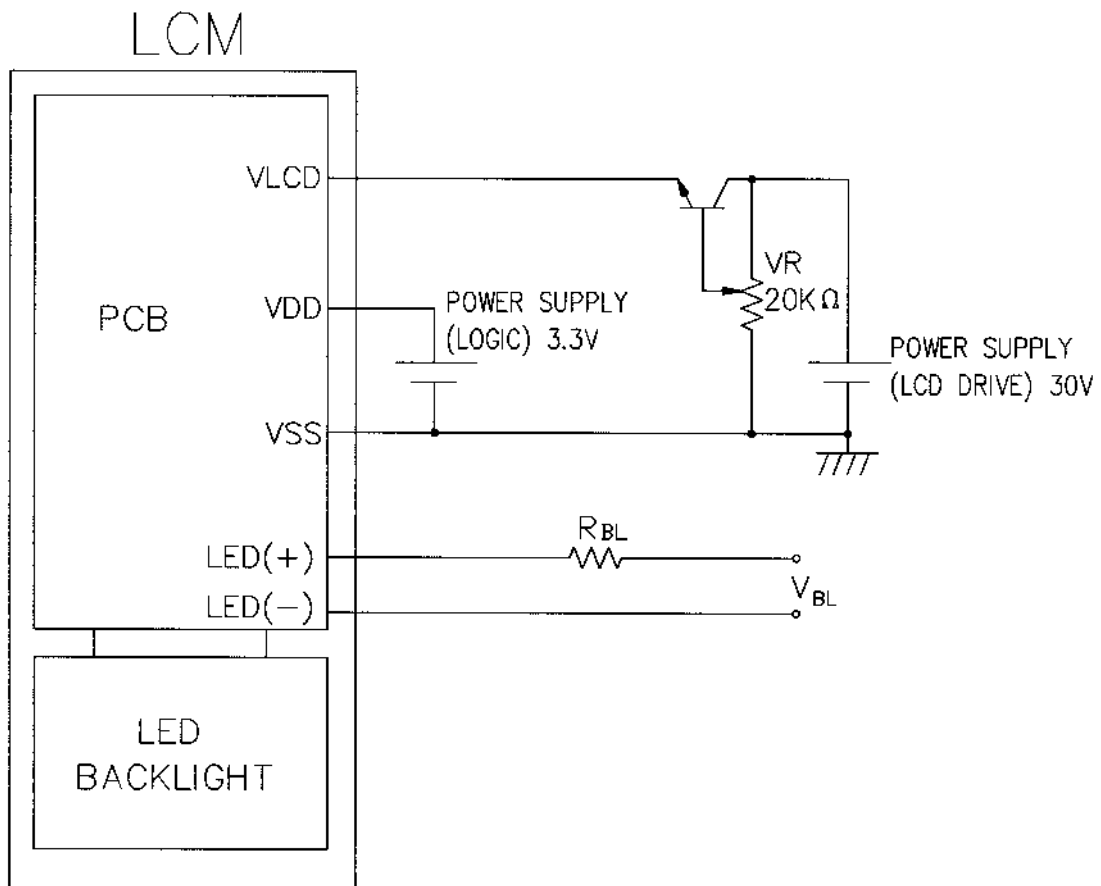

Recommended Value for  $R_{BL}$  &  $V_{BL}$

Item	$R_{BL}$	$V_{BL}$
Back Light Interface	White LED	White LED
LED(+),LED(-) PIN	33Ω	5 Vdc

**HANTRONIX, INC.**  
10080 BUBB RD.  
CUPERTINO, CA 95014

**Q.A.:**  
JK

**REV.:**  
1.1

**HDM2432L-T-xxTF**

**SHEET 10 OF 17**

**DATE:**  
7/22/02

# 8. TIMING CHARACTERISTICS

## 8-1. INTERFACE TIMING

Ⓢ VDD=3.0V±5%, T<sub>a</sub>=-20~85 ℃

Item	Symbol	Test condition	Min.	Typ.	Max.	Unit
CL2 Cycle Time	t <sub>C</sub>	Fig.a	125	-	-	ns
CL2 Pulse Width	t <sub>SWH</sub> ,t <sub>SWL</sub>	Fig.a	51	-	-	ns
CL2 Rise/Fall Time	t <sub>CR</sub> ,t <sub>CF</sub>	Fig.a	-	-	50	ns
Data Set Up Time	t <sub>DSU</sub>	Fig.a	30	-	-	ns
Data Hold Time	t <sub>DHD</sub>	Fig.a	40	-	-	ns
CL1 Cycle Time	t <sub>L</sub>	Fig.b	250	-	-	ns
CL1 "H" Pulse Width	t <sub>LWH</sub>	Fig.a , Fig.b	51	-	-	ns
CL1 Rise/Fall Time	t <sub>LR</sub> ,t <sub>LF</sub>	Fig.b	-	-	50	ns
CL2 To CL1 Delay Time	t <sub>CL</sub>	Fig.a	51	-	-	ns
CL1 To CL2 Delay Time	t <sub>LC</sub>	Fig.a	51	-	-	ns
FLM TO CL1 SETUP TIME	t <sub>FLS</sub>	Fig.b	30	-	-	ns
FLM TO CL1 HOLD TIME	t <sub>FLH</sub>	Fig.b	50	-	-	ns

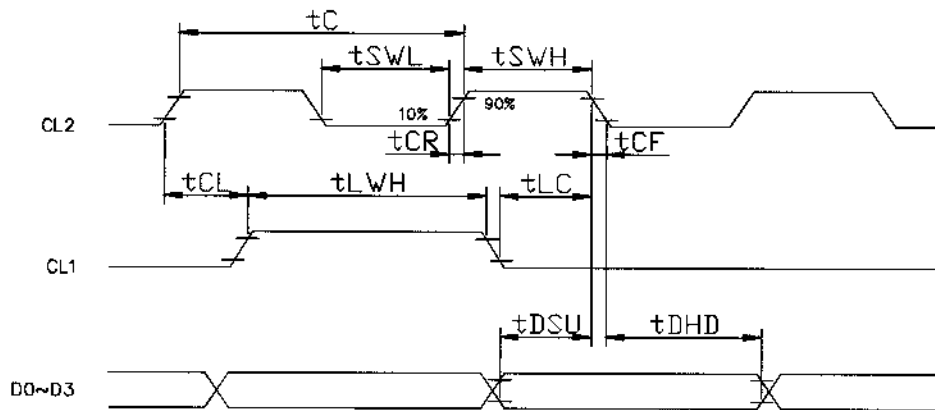

Fig . a Interface timing (SEGMENT)

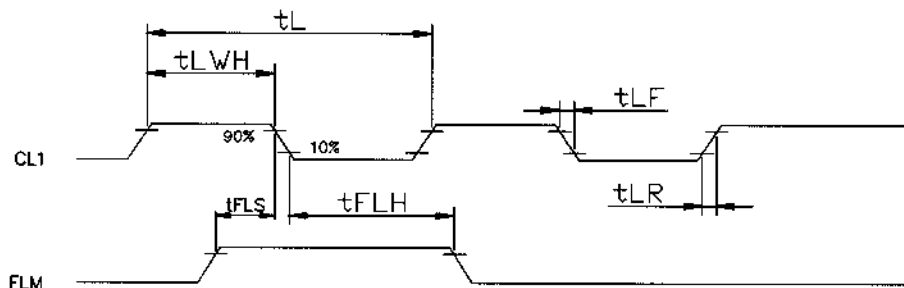
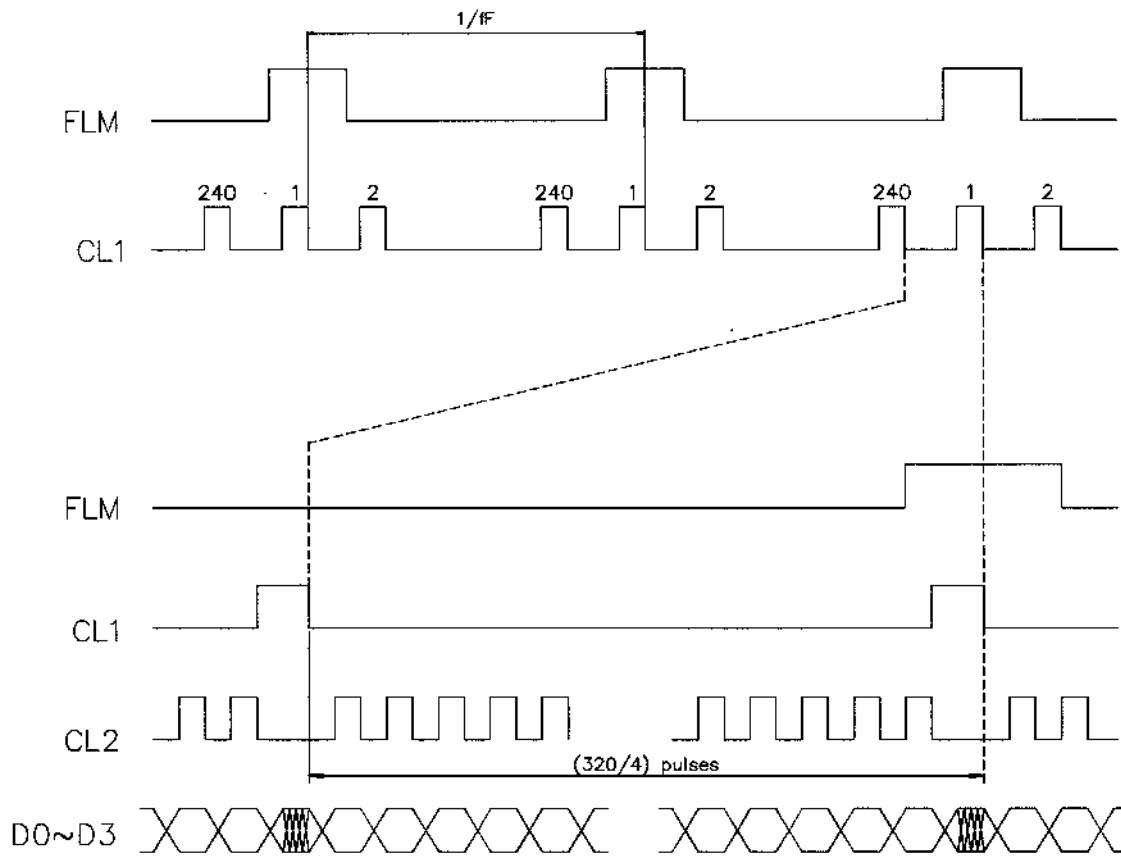

Fig . b Interface timing (COMMON)

<b>HANTRONIX, INC.</b> 10080 BUBB RD. CUPERTINO, CA 95014	Q.A.:	REV.:	<b>HDM2432L-T-xxTF</b>	SHEET 11 OF 17
	JK	1.1		DATE:

# 8-2. TIMING CHART OF INPUT SIGNAL



<b>HANTRONIX, INC.</b> 10080 BUBB RD. CUPERTINO, CA 95014	<b>Q.A.:</b> JK	<b>REV.:</b> 1.1	<b>HDM2432L-T-xxTF</b>	<b>SHEET 12 OF 17</b>
				<b>DATE:</b> 7/22/02

## 8-3. POWER ON/OFF TIMING

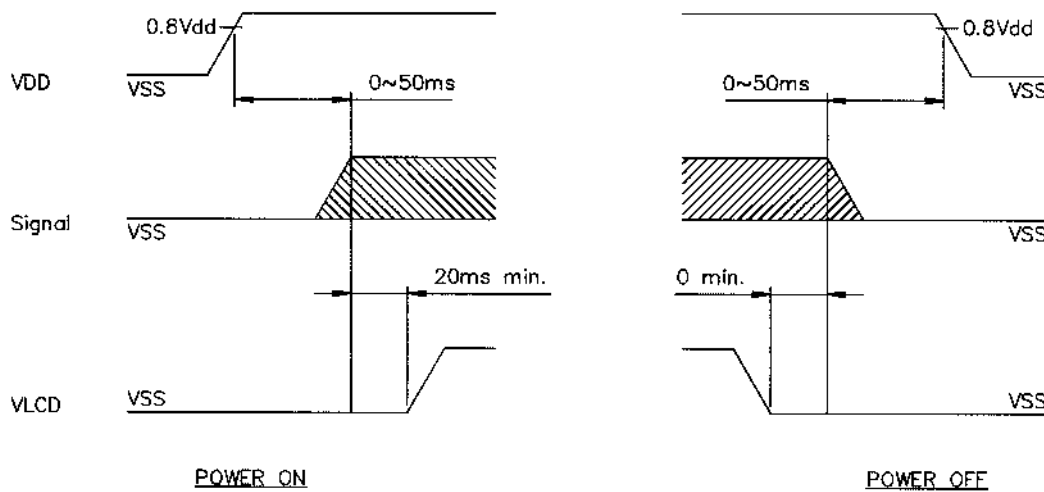

The missing pixels may occur when the LCM is driven beyond above power interface timing sequence.

<b>HANTRONIX, INC.</b> 10080 BUBB RD. CUPERTINO, CA 95014	<b>Q.A.:</b> JK	<b>REV.:</b> 1.1	<b>HDM2432L-T-xxTF</b>	<b>SHEET 13 OF 17</b>
				<b>DATE:</b> 7/22/02

# 8-4. DISPLAY PATTERN

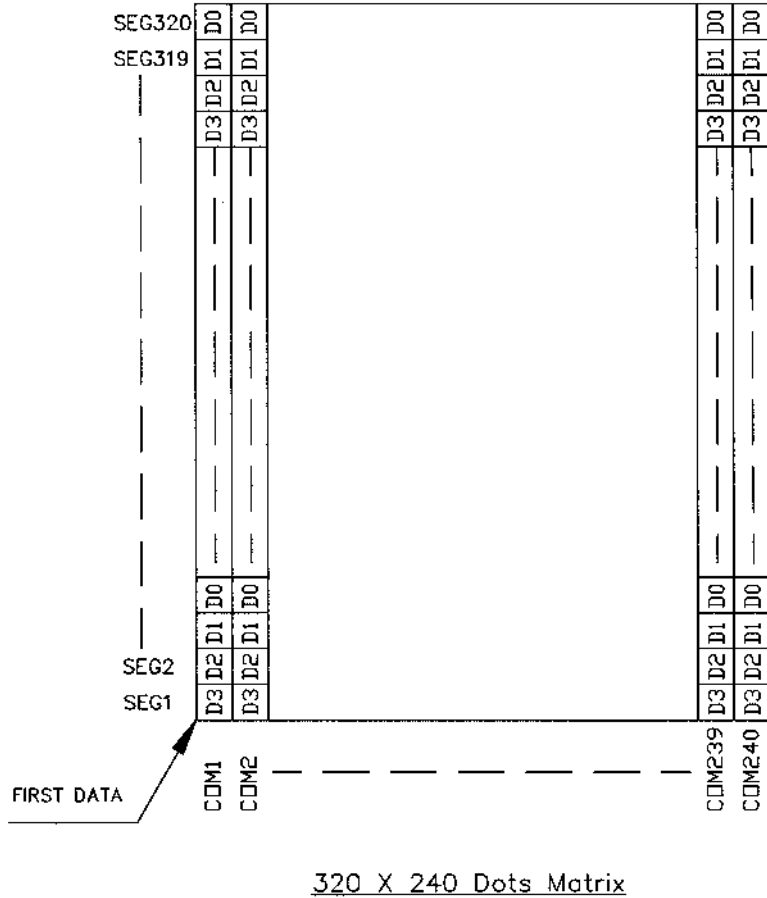

## 9. RELIABILITY TEST

NO	ITEM	CONDITION			STANDARD	NOTE
1	High Temp. Storage	70°C	120HR		Appearance without defect	
2	Low Temp. Storage	-20°C	120HR		Appearance without defect	
3	High Temp. High Humi. Storage	40°C 90%RH	120HR		Appearance without defect	
4	Thermal Shock	-20°C, 30min → 25°C, 5min → 70°C, 30min → 25°C, 5min (1cycle)			Appearance without defect	5 cycles

<b>HANTRONIX, INC.</b> 10080 BUBB RD. CUPERTINO, CA 95014	<b>Q.A.:</b>  JK	<b>REV.:</b>  1.1	<b>HDM2432L-T-xxTF</b>	SHEET 15 OF 17
				<b>DATE:</b> 7/22/02

NOTICE:

• SAFETY

- 1.If the LCD panel breaks, be careful not to get the liquid crystal to touch your skin.
- 2.If the liquid crystal touches your skin or clothes, please wash it off immediately by using soap and water.

• HANDLING

- 1.Avoid static electricity which can damage the CMOS LSI.
- 2.Do not remove the panel or frame from the module.
- 3.The polarizing plate of the display is very fragile. So, please handle it very carefully.
- 4.Do not wipe the polarizing plate with a dry cloth, as it may easily scratch the surface of plate.
- 5.Do not use ketonics solvent & Aromatic solvent, use with a soft cloth soaked with a cleaning naphtha solvent.

• STORAGE

- 1.Store the panel or module in a dark place where the temperature is  $25^{\circ}\text{C}\pm 5^{\circ}\text{C}$  and the humidity is below 65% RH.
- 2.Do not place the module near organics solvents or corrosive gases.
- 3.Do not crush, shake, or jolt the module.

• TERMS OF WARRANT

- 1.Acceptance inspection period  
The period is within one month after the arrival of contracted commodity at the buyer's factory site.
- 2.Applicable warrant period  
The period is within twelve months since the date of shipping out under normal using and storage conditions.

• THE OPERATING LIFE TIME OF BACK LIGHT

- LED : 40,000hrs for ILED=55mA, 25°C  
(Operating life time is defined as follows : The final brightness is at 50% of original brightness.)

<b>HANTRONIX, INC.</b> 10080 BUBB RD. CUPERTINO, CA 95014	<b>Q.A.:</b> JK	<b>REV.:</b> 1.1	<b>HDM2432L-T-xxTF</b>	<b>SHEET 16 OF 17</b>
				<b>DATE:</b> 7/22/02



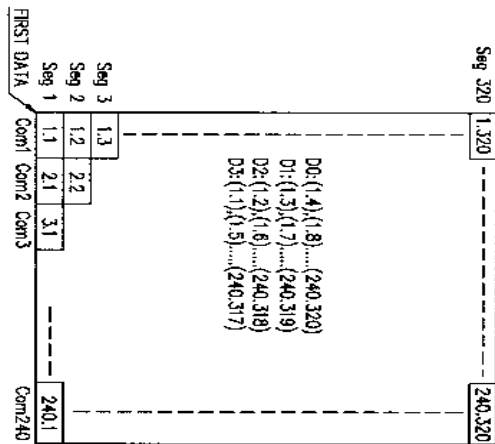
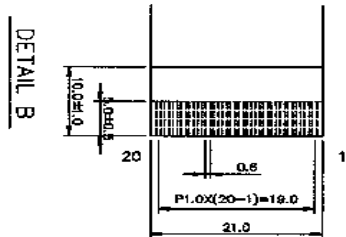
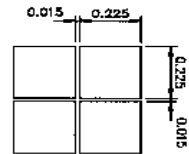
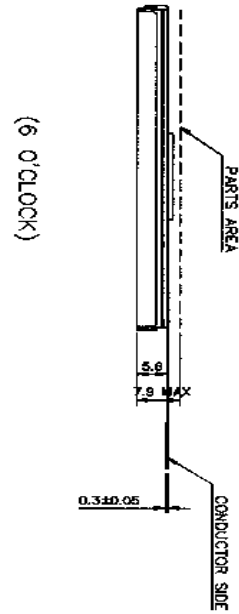
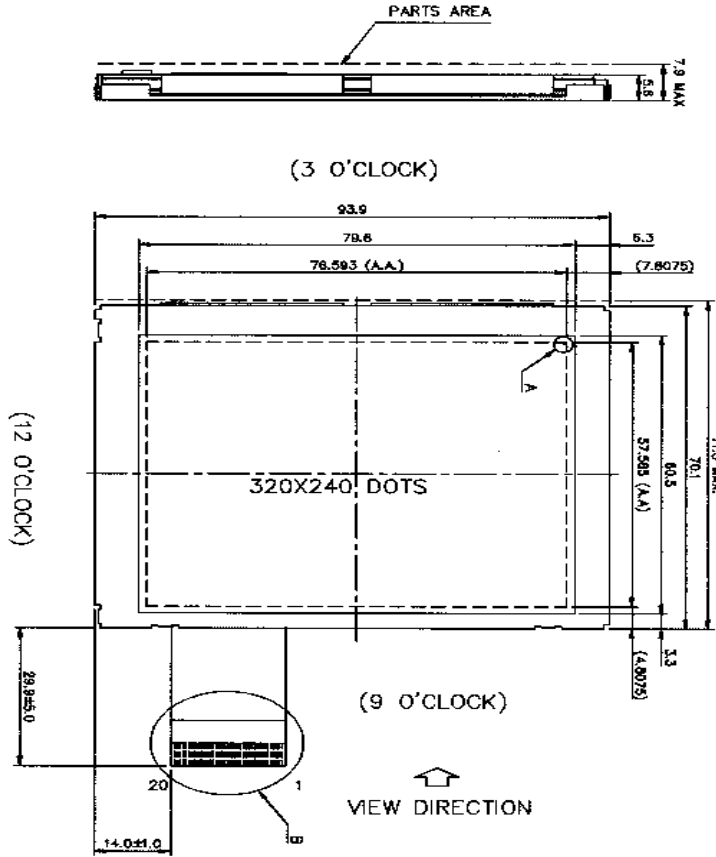

- NOTES:
1. RESOLUTION: 320X240 DOTS
  2. BACKLIGHT: LED (WHITE)
  3. FRAME MATERIAL: SECC
  4. GLASS THICKNESS: 0.7 mm

**HANTRONIX, INC.**  
10080 BUBB RD.  
CUPERTINO, CA 95014

Q.A.:  
JK

REV.:  
1.1

HDM2432L-T-xxTF

SHEET 17 OF 17

DATE:  
7/22/02