

IEC Appliance Inlet C14 or C18 with Filter, ECO design, Front- or Rear Side Mounting

Standard- or Medical-Filter



Snap-in mounting from front side
Protection class II

C14

 70° C



Description

- Panel Mount:
Screw-on version from front or rear side, snap-in version from front side
- 2 Functions:
Appliance Inlet, protection class I or II, Line filter in standard and medical version Quick connect terminals 6.3 x 0.8 mm

Approvals

- VDE License Number: 40016382
- UL License Number: E72928

Characteristics

- Compact high performance filter
- Optimal shielding due to completely closed filter case, unpotted
- Designed for standard and medical applications
- Suitable for assembly in metal plated plastic housings
- Qualified for use in equipment according IEC/EN 60950

Other versions on request

- Snap-in for panel thickness >2mm to 3mm
- Solder terminals
- Class X1 capacitor for enhanced surge withstand voltage
- Medical version M80

References

[General Product Information](#)

Weblinks

[Approvals](#), [RoHS](#), [CHINA-RoHS](#), [Mating Connectors](#), [e-Store](#), [Distributor-Stock-Check](#), [Accessories](#)

Technical Data

Ratings IEC	1 - 10A @ Ta 40 °C / 250VAC; 50Hz	Appliance-Inlet/-Outlet	C14 acc. to IEC/EN 60320-1, UL 498, CSA C22.2 no. 42 (for cold conditions) pin-temperature 70 °C, 10A, Protection Class 1 or 2
Ratings UL/CSA	1 - 15A @ Ta 40 °C / 250VAC; 60Hz	Line Filter	Standard and Medical Version, IEC 60939, IEC 60601-1, UL 1283, UL 544, EN 133 200, CSA C22.2 no. 8 Technical details
Leakage Current	standard < 0.5mA (250V / 60Hz) medical < 5 µA (250V / 60 Hz)	MTBF	> 3'000'000h acc. to MIL-HB-217 F
Dielectric Strength	> 1.7kVDC between L-N > 2.7kVDC between L/N-PE Test voltage (2 sec)		
Allowable Operation Temp.	-25°C to 85°C		
Climatic Category	25/085/21 acc. to IEC 60068-1		
Degree of Protection	from front side IP 40 acc. to IEC 60529		
Protection Class	Suitable for appliances with protection class 1 or 2 acc. to IEC 61140		
Terminal	Quick connect terminals 6.3 x 0.8 mm		
Panel Thickness s	Screw: max 8 mm Mounting screw torque max 0.5Nm Snap-in: 0.8mm to 2 mm (all steps with one variant)		
Material: Housing	Themoplast / steel tin-plated, black / metallic, UL 94V-0		

Dimensions

54.5 mm
 Front or rear side mounting for screws with nuts or blind rivets (panel cutout for frontside mounting)

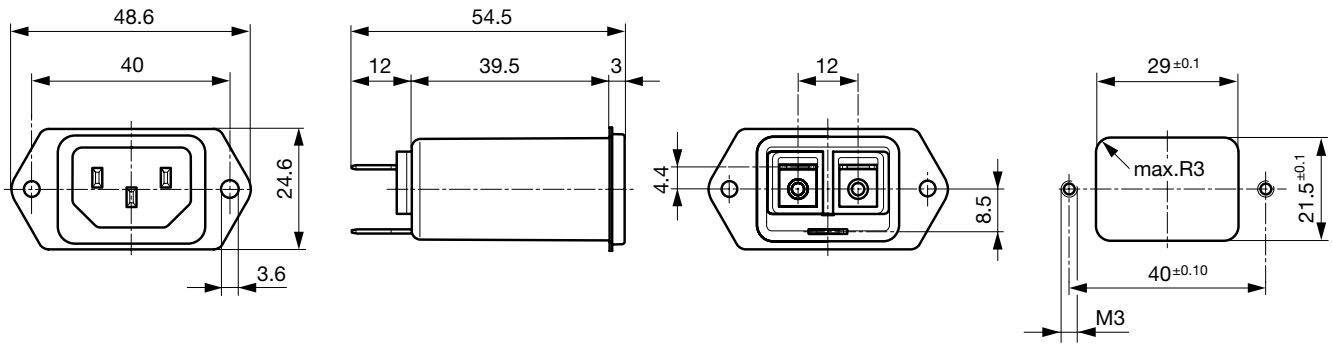

Rear side mounting with pre-formed, threaded holes for M3 screws (panel cutout for rear side mounting)

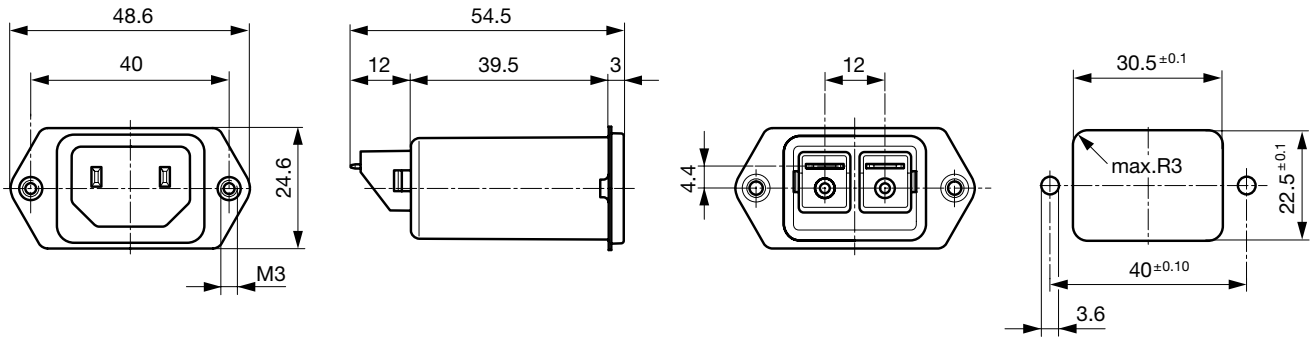

Dimensions for class II version also apply to class I

Snap-in mounting from front side

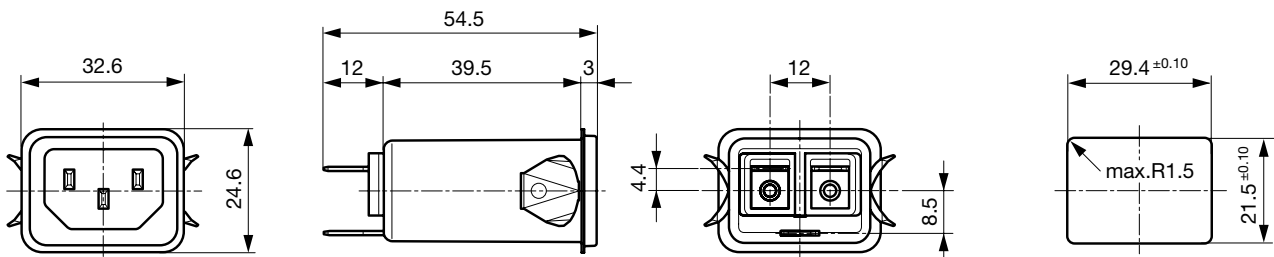

Dimensions for class I version also apply class II

Technical Data of Filter-Components

Rated Current [A]	Filter-Type	Inductances L [mH]	Capacitance CX [nF]	Capacitance CY [nF]	R [MΩ]
1	Standard Version	2 x 12	100	2.2	-
2	Standard Version	2 x 5.2	100	2.2	-
4	Standard Version	2 x 2	100	2.2	-
6	Standard Version	2 x 0.8	100	2.2	-
10	Standard Version	2 x 0.4	100	2.2	-
15	Standard Version	2 x 0.1	100	2.2	-
1	Medical Version (M5)	2 x 12	100	-	1
2	Medical Version (M5)	2 x 5.2	100	-	1
4	Medical Version (M5)	2 x 2	100	-	1
6	Medical Version (M5)	2 x 0.8	100	-	1
10	Medical Version (M5)	2 x 0.4	100	-	1
15	Medical Version (M5)	2 x 0.1	100	-	1
1	Bleed Resistor Version	2 x 12	100	2.2	1
2	Bleed Resistor Version	2 x 5.2	100	2.2	1
4	Bleed Resistor Version	2 x 2	100	2.2	1
6	Bleed Resistor Version	2 x 0.8	100	2.2	1
10	Bleed Resistor Version	2 x 0.4	100	2.2	1
15	Bleed Resistor Version	2 x 0.1	100	2.2	1

Diagrams

Standard version

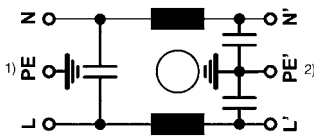

1) Line
2) Load

Bleed resistor version

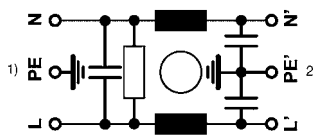

1) Line
2) Load

Medical version M5

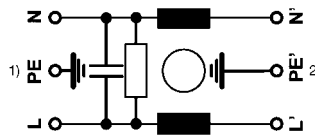

1) Line
2) Load

Medical version M5, prot. class II

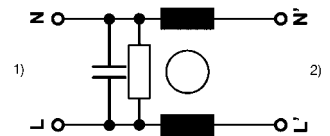

1) Line
2) Load

Attenuation Loss

--- differential mode ____ common mode

Standard version

1 A

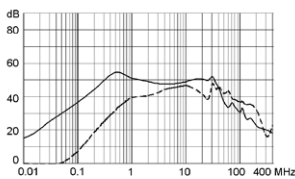

2 A

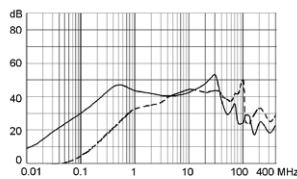

4 A

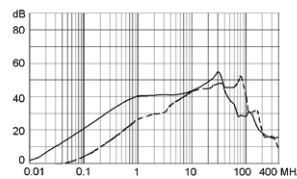

6 A

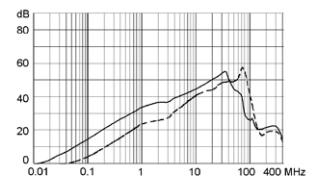

10 A

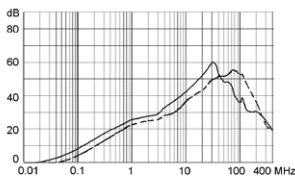

15 A

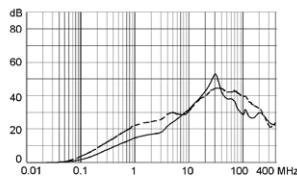

Medical version (M5)

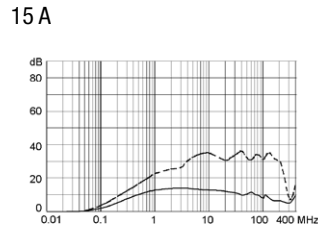
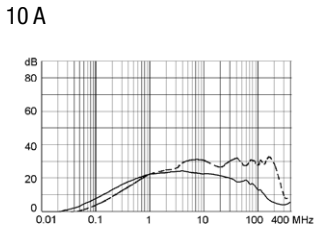
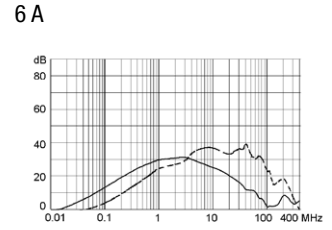
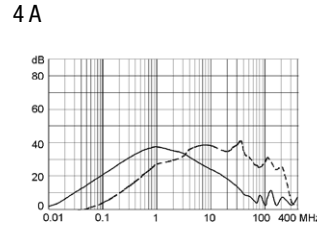
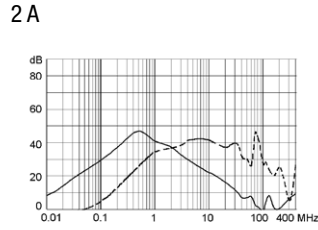
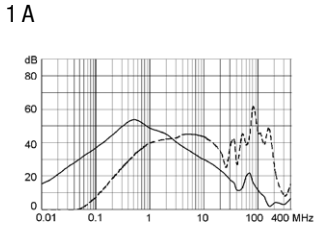

Variants

Rated Current [A]	Filter-Type	Panel mounting	Mounting side	Protection Class	Order Number
1	Standard Version	Screw-on/Rivet	Front-/Rear-Side	1	5120.0000.0
2	Standard Version	Screw-on/Rivet	Front-/Rear-Side	1	5120.0001.0
4	Standard Version	Screw-on/Rivet	Front-/Rear-Side	1	5120.0003.0
6	Standard Version	Screw-on/Rivet	Front-/Rear-Side	1	5120.0004.0
10	Standard Version	Screw-on/Rivet	Front-/Rear-Side	1	5120.0006.0
15	Standard Version	Screw-on/Rivet	Front-/Rear-Side	1	5120.0007.0
1	Standard Version	Screw	Rear-Side	1	5120.1000.0
2	Standard Version	Screw	Rear-Side	1	5120.1001.0
4	Standard Version	Screw	Rear-Side	1	5120.1003.0
6	Standard Version	Screw	Rear-Side	1	5120.1004.0
10	Standard Version	Screw	Rear-Side	1	5120.1006.0
15	Standard Version	Screw	Rear-Side	1	5120.1007.0
1	Standard Version	Snap-in	Front-Side	1	5120.2000.0
2	Standard Version	Snap-in	Front-Side	1	5120.2001.0
4	Standard Version	Snap-in	Front-Side	1	5120.2003.0
6	Standard Version	Snap-in	Front-Side	1	5120.2004.0
10	Standard Version	Snap-in	Front-Side	1	5120.2006.0
15	Standard Version	Snap-in	Front-Side	1	5120.2007.0
1	Medical Version (M5)	Screw-on/Rivet	Front-/Rear-Side	1	5120.0300.0
2	Medical Version (M5)	Screw-on/Rivet	Front-/Rear-Side	1	5120.0301.0
4	Medical Version (M5)	Screw-on/Rivet	Front-/Rear-Side	1	5120.0303.0
6	Medical Version (M5)	Screw-on/Rivet	Front-/Rear-Side	1	5120.0304.0
10	Medical Version (M5)	Screw-on/Rivet	Front-/Rear-Side	1	5120.0306.0
15	Medical Version (M5)	Screw-on/Rivet	Front-/Rear-Side	1	5120.0307.0
1	Medical Version (M5)	Screw	Rear-Side	1	5120.1300.0
2	Medical Version (M5)	Screw	Rear-Side	1	5120.1301.0
4	Medical Version (M5)	Screw	Rear-Side	1	5120.1303.0
6	Medical Version (M5)	Screw	Rear-Side	1	5120.1304.0
10	Medical Version (M5)	Screw	Rear-Side	1	5120.1306.0
15	Medical Version (M5)	Screw	Rear-Side	1	5120.1307.0
1	Medical Version (M5)	Snap-in	Front-Side	1	5120.2300.0
2	Medical Version (M5)	Snap-in	Front-Side	1	5120.2301.0
4	Medical Version (M5)	Snap-in	Front-Side	1	5120.2303.0
6	Medical Version (M5)	Snap-in	Front-Side	1	5120.2304.0
10	Medical Version (M5)	Snap-in	Front-Side	1	5120.2306.0
15	Medical Version (M5)	Snap-in	Front-Side	1	5120.2307.0

Rated Current [A]	Filter-Type	Panel mounting	Mounting side	Protection Class	Order Number
2	Medical Version (M5)	Screw-on/Rivet	Front-/Rear-Side	2	5120.0301.1
4	Medical Version (M5)	Screw-on/Rivet	Front-/Rear-Side	2	5120.0303.1
6	Medical Version (M5)	Screw-on/Rivet	Front-/Rear-Side	2	5120.0304.1
1	Medical Version (M5)	Screw	Rear-Side	2	5120.1300.1
2	Medical Version (M5)	Screw	Rear-Side	2	5120.1301.1
4	Medical Version (M5)	Screw	Rear-Side	2	5120.1303.1
6	Medical Version (M5)	Screw	Rear-Side	2	5120.1304.1
10	Medical Version (M5)	Screw	Rear-Side	2	5120.1306.1
1	Medical Version (M5)	Snap-in	Front-Side	2	5120.2300.1
2	Medical Version (M5)	Snap-in	Front-Side	2	5120.2301.1
4	Medical Version (M5)	Snap-in	Front-Side	2	5120.2303.1
6	Medical Version (M5)	Snap-in	Front-Side	2	5120.2304.1
10	Medical Version (M5)	Snap-in	Front-Side	2	5120.2306.1
15	Medical Version (M5)	Snap-in	Front-Side	2	5120.2307.1
1	Bleed Resistor Version	Screw-on/Rivet	Front-/Rear-Side	1	5120.0200.0
2	Bleed Resistor Version	Screw-on/Rivet	Front-/Rear-Side	1	5120.0201.0
4	Bleed Resistor Version	Screw-on/Rivet	Front-/Rear-Side	1	5120.0203.0
6	Bleed Resistor Version	Screw-on/Rivet	Front-/Rear-Side	1	5120.0204.0
10	Bleed Resistor Version	Screw-on/Rivet	Front-/Rear-Side	1	5120.0206.0
15	Bleed Resistor Version	Screw-on/Rivet	Front-/Rear-Side	1	5120.0207.0
1	Bleed Resistor Version	Screw	Rear-Side	1	5120.1200.0
2	Bleed Resistor Version	Screw	Rear-Side	1	5120.1201.0
4	Bleed Resistor Version	Screw	Rear-Side	1	5120.1203.0
6	Bleed Resistor Version	Screw	Rear-Side	1	5120.1204.0
10	Bleed Resistor Version	Screw	Rear-Side	1	5120.1206.0
15	Bleed Resistor Version	Screw	Rear-Side	1	5120.1207.0
1	Bleed Resistor Version	Snap-in	Front-Side	1	5120.2200.0
2	Bleed Resistor Version	Snap-in	Front-Side	1	5120.2201.0
4	Bleed Resistor Version	Snap-in	Front-Side	1	5120.2203.0
6	Bleed Resistor Version	Snap-in	Front-Side	1	5120.2204.0
10	Bleed Resistor Version	Snap-in	Front-Side	1	5120.2206.0
15	Bleed Resistor Version	Snap-in	Front-Side	1	5120.2207.0

- 15 A version only according UL/CSA

- Type for screw-on mounting from rear side has pre-threaded holes for M3 screws

Packaging unit 10 Pcs

Accessories

Description

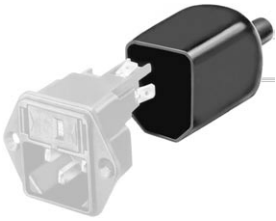

Assorted Covers
Rear Cover

0859.0048



Cord retaining kits
Cord retaining strain relief

Flat head, Z

0888.0021

Flat head, E

4700.0005

Flat head, G

4700.0007

Mating Outlets/Connectors

Category / Description

Appliance Outlet Overview complete



IEC Appliance Outlet F, Screw-on Mounting, Front Side, Solder or Quick-connect Terminal

4787

IEC Appliance Outlet F, Snap-in Mounting, Front Side, Solder or Quick-connect Terminal

4788

IEC Appliance Outlet F or H, Screw-on Mounting, Front Side, Solder, PCB or Quick-connect Terminal

5091

IEC Appliance Outlet F or H, Screw-on Mounting, Front Side, Solder or Quick-connect Terminal

5092

[Appliance Outlet further types to 5120](#)

Connector Overview complete



IEC Connector C15, Rewireable, Straight

0101

IEC Connector C15A, Rewireable, Straight

0102

IEC Connector C15A, Rewireable, Straight

0102-G

IEC Connector C15A, Rewireable, Angled

0112

IEC Connector C13, Rewireable, Angled

4012

[Connector further types to 5120](#)

...

Power Cord Overview complete



Power Cord with IEC Connector C13, Angled

0311

Power Cord with IEC Connector C13, Angled

3011

Power Cord with IEC Connector C13, Angled

3012

Power Cord with IEC Connector C13, Angled

3013

Power Cord with IEC Connector C13

3020

[Power Cord further types to 5120](#)

...