

Performance Specification

Model	Mark ing	Maximum							Resistance	
		V _{max}	I _{max}	I _{hold}	I _{trip}	P _d	Time To Trip			
				@25°C	@25°C	Typ.	Current	Time	R _{i min}	R _{1max}
		(V dc)	(A)	(A)	(A)	(W)	(A)	(Sec)	(Ω)	(Ω)
JSMD0805-005	0	30.0	100	0.05	0.20	0.5	0.5	1.50	2.000	10.000
JSMD0805-010	1	15.0	100	0.10	0.30	0.5	0.5	1.50	1.000	6.000
JSMD0805-010/24	1	24.0	100	0.10	0.30	0.5	0.5	1.50	1.000	6.000
JSMD0805-020	2	9.0	100	0.20	0.50	0.5	8.0	0.02	0.650	3.500
JSMD0805-035	3	6.0	100	0.35	0.75	0.5	8.0	0.10	0.250	1.200
JSMD0805-035/9	3	9.0	100	0.35	0.75	0.5	8.0	0.10	0.250	1.200
JSMD0805-050	5	6.0	100	0.50	1.00	0.5	8.0	0.10	0.150	0.850
JSMD0805-050/9	5	9.0	100	0.50	1.00	0.5	8.0	0.10	0.150	0.850
JSMD0805-075	7	6.0	40	0.75	1.50	0.6	8.0	0.20	0.090	0.385
JSMD0805-100	F	6.0	100	1.00	1.95	0.6	8.0	0.30	0.060	0.230
JSMD0805-110	F	6.0	100	1.10	2.20	0.6	8.0	0.30	0.060	0.210

V_{max} = Maximum operating voltage device can withstand without damage at rated current (I_{max}).

I_{max} = Maximum fault current device can withstand without damage at rated voltage (V_{max}).

I_{hold} = Hold Current. Maximum current device will not trip in 25°C still air.

I_{trip} = Trip Current. Minimum current at which the device will always trip in 25°C still air.

P_d = Power dissipation when device is in the tripped state in 25°C still air environment at rated voltage.

R_{i min/max} = Minimum/Maximum device resistance prior to tripping at 25°C.



R_{1max} = Maximum device resistance is measured one hour post reflow.

CAUTION : Operation beyond the specified ratings may result in damage and possible arcing and flame.

Environmental Specifications

Test	Conditions	Resistance change
Passive aging	+85°C, 1000 hrs.	±5% typical
Humidity aging	+85°C, 85% R.H. , 168 hours	±5% typical
Thermal shock	+85°C to -40°C, 20 times	±33% typical
Resistance to solvent	MIL-STD-202, Method 215	No change
Vibration	MIL-STD-202, Method 201	No change
Ambient operating conditions : - 40 °C to +85 °C		
Maximum surface temperature of the device in the tripped state is 125 °C		

Agency Approval and Environmental Compliance

Agency	File Number	Regulation	Standard
UL	E217453		2011/65/EU
TUV	pending		EN14582

Thermal Derating Chart

Recommended Hold Current(A) at Ambient Temperature(°C)

Model	Ambient Operation Temperature								
	-40°C	-20°C	0°C	25°C	40°C	50°C	60°C	70°C	85°C
JSMD0805-005	0.078	0.068	0.06	0.05	0.042	0.038	0.034	0.03	0.021
JSMD0805-010	0.14	0.12	0.11	0.10	0.08	0.07	0.06	0.05	0.03
JSMD0805-020	0.28	0.25	0.23	0.20	0.17	0.14	0.12	0.10	0.07
JSMD0805-035	0.47	0.44	0.39	0.35	0.30	0.27	0.24	0.20	0.14
JSMD0805-050	0.68	0.62	0.55	0.50	0.40	0.37	0.33	0.29	0.23
JSMD0805-075	1.00	0.90	0.79	0.75	0.63	0.57	0.53	0.41	0.34
JSMD0805-100	1.35	1.25	1.15	1.00	0.82	0.74	0.65	0.55	0.42
JSMD0805-110	1.45	1.35	1.20	1.10	0.92	0.84	0.75	0.65	0.52

Thermal Derating Curve

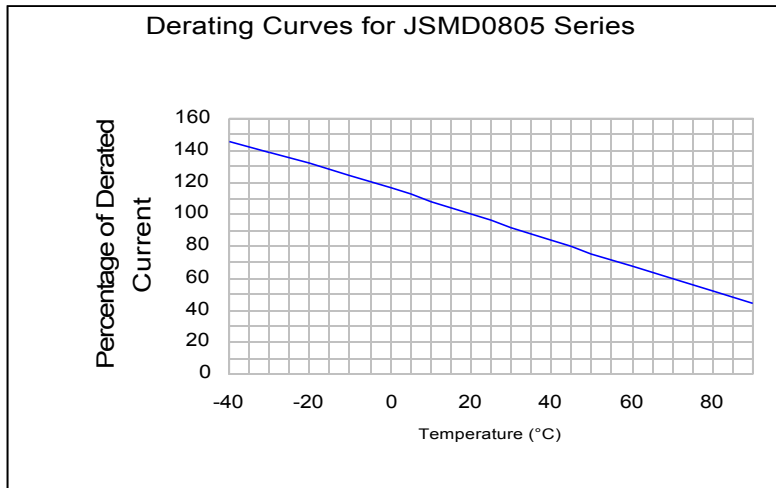

Average Time-Current Curve

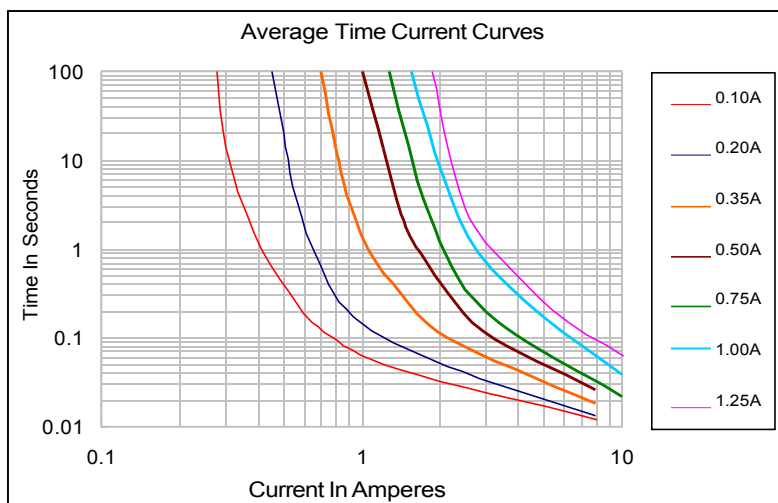

Soldering Parameters

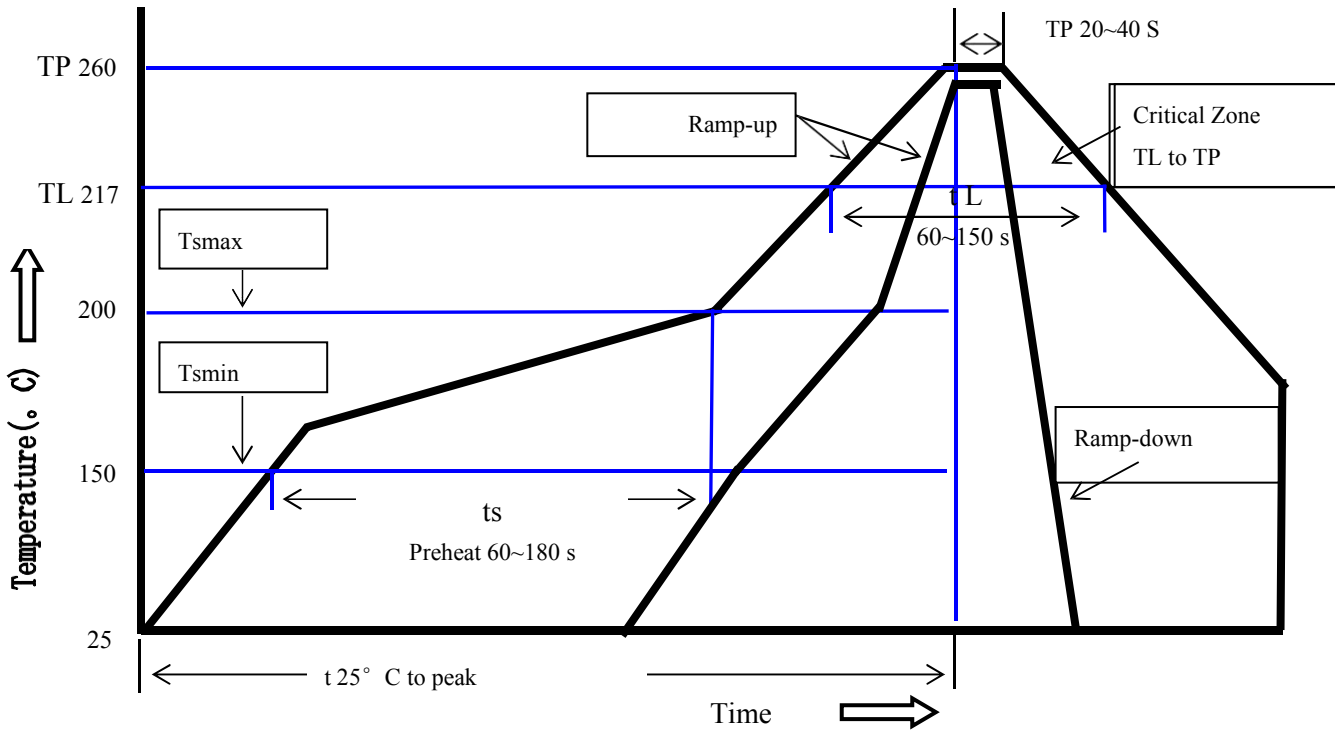

Profile Feature	Pb-Free Assembly
Average Ramp-Up Rate(Ts max to T p)	3°C/second max.
Preheat	
-Temperature Min(Ts min)	150°C
-Temperature Max(Ts max)	200°C
-Time(Ts min to Ts max)	60~180 seconds
Time maintained above:	
-Temperature(TL)	217°C
-Time(tL)	60~150 seconds
Peak Temperature(Tp)	260°C
Ramp-Down Rate	6°C/second max.
Time 25°C to Peak Temperature	8 minutes max
Storage Condition	0°C~35°C, ≤70%RH

Recommended reflow methods: IR, vapor phase oven, hot air oven, N2 environment for lead-free

Recommended maximum paste thickness is 0.25mm

Devices can be cleaned using standard industry methods and solvents.

Note 1: All temperature refer to topside of the package, measured on the package body surface.

Note 2: If reflow temperatures exceed the recommended profile, devices may not meet the performance requirements.

Physical Dimensions(mm.)

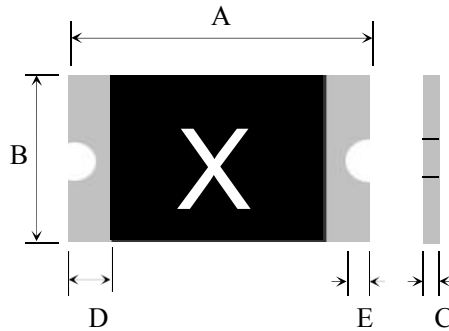

Model	A		B		C		D	E
	Min.	Max.	Min.	Max.	Min.	Max.	Min.	Min.
JSMD0805-005	2.00	2.20	1.20	1.50	0.50	1.00	0.20	0.10
JSMD0805-010	2.00	2.20	1.20	1.50	0.50	1.00	0.20	0.10
JSMD0805-010/24	2.00	2.20	1.20	1.50	0.50	1.00	0.20	0.10
JSMD0805-020	2.00	2.20	1.20	1.50	0.45	1.00	0.20	0.10
JSMD0805-035	2.00	2.20	1.20	1.50	0.45	1.00	0.20	0.10
JSMD0805-035/9	2.00	2.20	1.20	1.50	0.45	1.00	0.20	0.10
JSMD0805-050	2.00	2.20	1.20	1.50	0.30	0.60	0.20	0.10
JSMD0805-050/9	2.00	2.20	1.20	1.50	0.30	0.60	0.20	0.10
JSMD0805-075	2.00	2.20	1.20	1.50	0.40	1.00	0.20	0.10
JSMD0805-100	2.00	2.20	1.20	1.50	0.50	1.10	0.20	0.10
JSMD0805-110	2.00	2.20	1.20	1.50	0.50	1.20	0.20	0.10

Termination Pad Characteristics

Terminal pad materials: Tin-plated Nickel-Copper

Terminal pad solder ability: Meets EIA specification RS186-9E and ANSI/J-STD-002 Category 3.

Recommended Pad Layout (mm.)

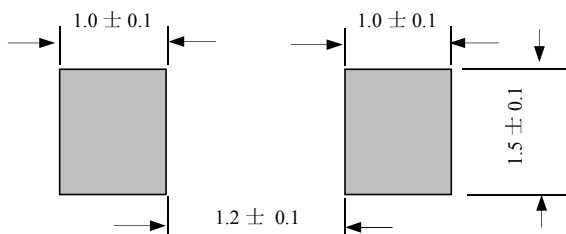

Packaging Quantity

Part Number	Quantity
JSMD 0805 Series	4,000 pcs/reel

Tape & reel packaging per EIA481-1

Tape And Reel Specifications (mm)

Governing Specifications	EIA 481-1
W	8.0 ± 0.3
P0	4.0 ± 0.10
P1	4.0 ± 0.10
P2	2.0 ± 0.05
A0	1.45 ± 0.10
B0	2.30 ± 0.10
B1max.	4.35
D0	1.55 + 0.1, -0
F	3.5 ± 0.05
E1	1.75 ± 0.10
E2min.	6.25
T	0.25
T1max.	0.1
K0	0.74 ± 0.1
Leader min.	390
Trailer min.	160
Reel Dimensions	
A max.	178
N min.	60
W1	9.0 ± 0.5
W2	12.0 ± 0.05

EIA Tape Component Dimensions

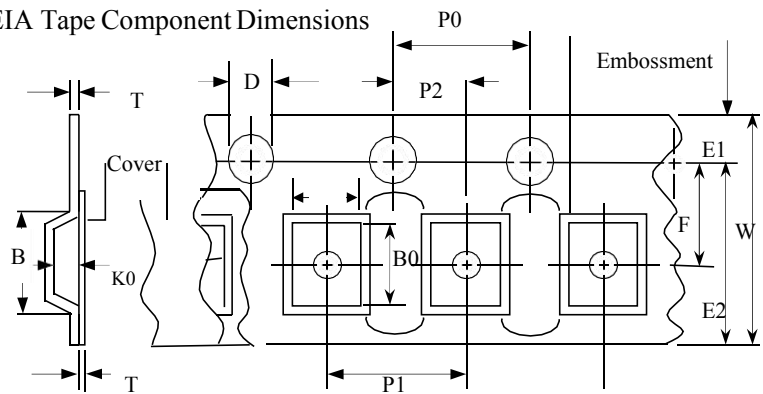

EIA Reel Dimensions

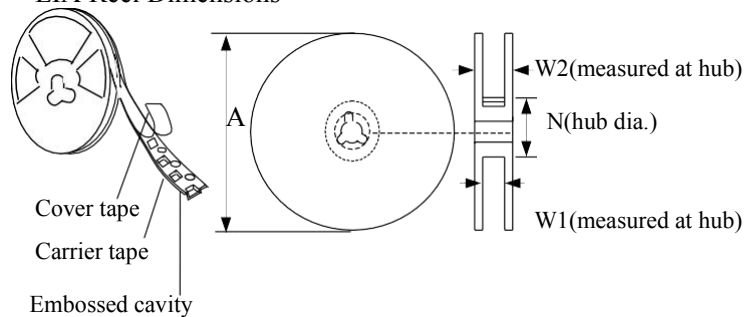

Storage And Handling

- Storage conditions: 35°C max, 70% R.H.
- Devices may not meet specified performance if storage conditions are exceeded.

Part Number System

J SMD0805- □□□□ / □□□

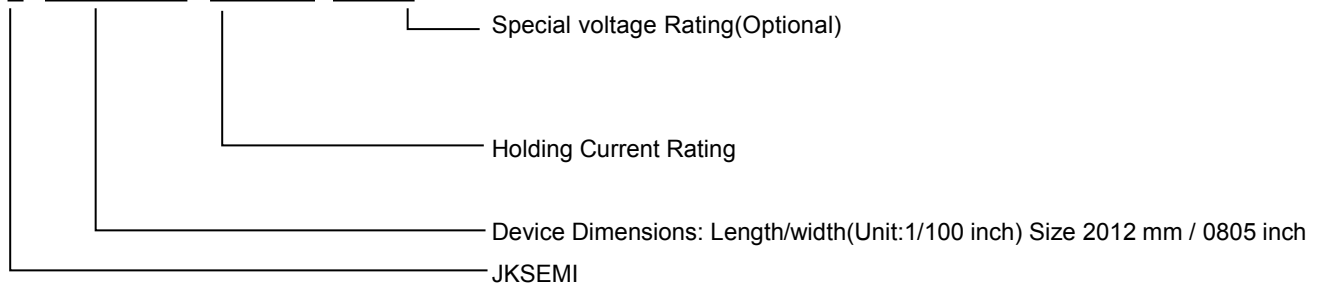

Cross Reference

JKSEMI	Cross Reference				
	TYCO/Raychem	Littelfuse	Bourns / Multifuse®	Polytronics / EVERFUSE®	SEA-LAND
JSMD0805-005	-	-	-	SMD0805P005TF	SMD0805-005
JSMD0805-010	picoSMDC010S	0805L010	MF-PSMF010X	SMD0805P010TF	SMD0805-010
JSMD0805-010/24	-	-	MF-PSMF010/24X	SMD0805P010TF/24	SMD0805-010-24V
JSMD0805-020	picoSMDC020S	0805L020	MF-PSMF020X	SMD0805P020TF	SMD0805-020
JSMD0805-035	picoSMDC035S	0805L035	MF-PSMF035X	SMD0805P035TF	SMD0805-035
JSMD0805-035/9	-	-	-	-	-
JSMD0805-050	picoSMDC050S	0805L050	MF-PSMF050X	SMD0805P050TF	SMD0805-050
JSMD0805-050/9	-	-	-	-	-
JSMD0805-075	picoSMDC075S	0805L075	MF-PSMF075X	SMD0805P075TF	SMD0805-075
JSMD0805-100	-	0805L100	-	SMD0805P100TFT	SMD0805-100
JSMD0805-110	picoSMDC110S	0805L110	MF-PSMF110X	SMD0805P110TF	SMD0805-110

“Raychem” is a registered trademark of Tyco Electronics.

“Littelfuse” is a registered trademark of Littelfuse.

“Multifuse” is a registered trademark of bourns, Inc.

“EVERFUSE” is a registered trademark of Polytronics Technology Corp.

“SEA-LAND” is a registered trademark of Sea-Land electronic corp.

Website: <http://www.jksemit.com>

For additional information, please contact your local Sales Representative.

©Copyright 2016, jksemit



is a registered trademark of jksemit All rights are reserved