

One-Touch Locking Style Small Sized Circular Connectors

CM10 Series (D6) Type



◆ OUTLINE

CM10 series (D6) type is a small sized waterproof circular connector with push on locking and turnoff unlocking mechanism. The plug will be easily locked with the receptacle when you push on. Rotating the coupling ring, the plug will be unlocked when you need to unmate. The plug can not be unmated from the receptacle by such an unexpected force like the cable being pulled. CM10 with (D6) has a solid construction with the metal shell. The weight of the connector is lighter with the light metal backshell and the resin clamp nut than the CM10 series connectors which we had released earlier. CM10 series with (D6) can be used with a wide range of applications since it is small size and waterproof connector.



◆ FEATURES

1. Solid structure with a metal shell
2. One touch and reliable locking mechanism of push on and turnoff
3. With a grounding contact (Position 10)
4. Angle plug available for low-profile mounting
5. Lighter in weight by 30% than CM10 without (D6)

◆ SPECIFICATIONS

Item	2 Contacts	10 Contacts
Rated Current	3A Max. / Contact	
Rated Voltage	200V AC(r.m.s.) Max.	
Dielectric Withstanding Voltage	1500V AC(r.m.s.) / 1 minute	900V AC(r.m.s.) / 1 minute
Insulation Resistance	1,000M Ω Min. at 500V DC	
Operating Temperature Range	-25°C to +85°C	
Conductor Size	# 22	
Protection Rate	IP67 when mated (Receptacle : Individually waterproof)	
Applicable Wire	Receptacle, Cable Receptacle • Soldering only, 20AWG max. Plug • Crimp : 16AWG-20AWG • Soldering Use, : 16AWG Max.	Receptacle, Cable Receptacle • Soldering Use, : 20AWG Max Plug • Crimp : 20AWG-28AWG • Soldering Use, : 20AWG Max.

◆ MATERIAL/FINISH



Item	Receptacle
Pin Front Insulator	Synthetic Rubber/Black
Pin Rear Insulator	Plastic(UL94V-0)/Black
Pin Contact	Copper Alloy/Gold Plating
O Ring(Mounting Side)	Synthetic Rubber/Black
Receptacle Shell	Zinc Alloy/Nickel Plating
Retaining Ring	Copper Alloy/Gold Plating
Ground Lug	Copper Alloy/Gold Plating

Item	Cable Receptacle
Pin Front Insulator	Synthetic Rubber/Black
Pin Rear Insulator	Plastic(UL94V-0)/Black
Screw	Stainless Steel
Pin Contact	Copper Alloy/Gold Plating
Receptacle Shell	Zinc Alloy/Nickel Plating
Backshell	Zinc Alloy/Nickel Plating
Bushing	Synthetic Rubber/Black
Cable Clamp	Plastic(UL94V-0)/White
Clamp Nut	Zinc Alloy/Nickel Plating
Ground Lug	Copper Alloy/Gold Plating

Item	Plug
Socket Cover Insulator	Plastic(UL94V-0)/Black
Socket Insulator	Plastic(UL94V-0)/Black
Fixed Pin	Copper Alloy/Nickel Plating
Socket Contact	Copper Alloy/Gold Plating
Coupling Ring	Zinc Alloy/Nickel Plating
O Ring(Mating Side)	Synthetic Rubber/Black
Plug Shell	Zinc Alloy/Nickel Plating
Spring	Stainless Steel
Backshell	Aluminum Alloy/Nickel Plating
Bushing	Synthetic Rubber/Black
Cable Clamp	Plastic(UL94V-0)/White
Clamp Nut	Plastic(UL94V-0)/Black
Retaining Ring	Stainless Steel

© Specifications and/or dimensions in this catalog are subject to change without notice.
Your checking the latest specifications with our drawings would be highly appreciated.

Waterproof
IP 67

Lock Type
Push-On

▶ 10-Contact Plug

- Contact Style : Socket
- Termination : Solder or Crimp
- The contact is sold separately.

Straight Plug

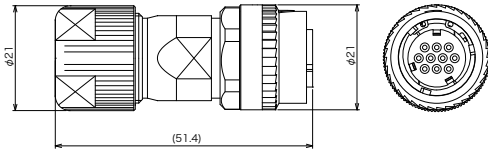

Right Angle Plug

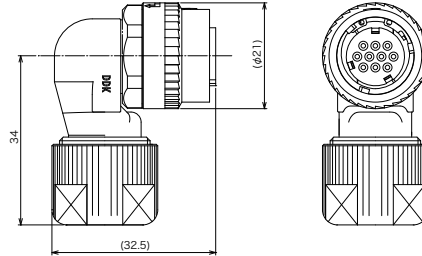

Straight Plug P/N	Right Angle Plug P/N	Cable Outside Dia.
CM10-SP10S-S(D6)	CM10-AP10S-S(D6)	φ 4.0 ~ φ 6.0
CM10-SP10S-M(D6)	CM10-AP10S-M(D6)	φ 6.0 ~ φ 9.0
CM10-SP10S-L(D6)	CM10-AP10S-L(D6)	φ 9.0 ~ φ 11.6

Note: The applicable cable outside diameter is in the case of cabtyre cable.
 Please contact the nearest sales office when you use a different cable.
 Regarding the wiring tools, please refer to the instruction manuals attached on the top-page of this connector catalogue.

▶ Contact of 10-Contact Plug

Loose Piece Contact

Item	Contact P/N (100 pcs in 1 bag)	Applicable Wire		Hand Tool P/N	Extraction Tool P/N
		Conductor Size	Insulation Dia.		
Crimping Type	CM10-#22SC(C1)(D8)-100	20 ~ 22AWG	φ 1.10 ~ φ 1.87	357J-50446T	357J-50548T
	CM10-#22SC(C2)(D8)-100	23 ~ 28AWG	φ 0.80 ~ φ 1.50	357J-50447T	
Soldering Type	CM10-#22SC(S1)(D8)-100	20 AWG Max.			

1. The packaging specification is 100 pcs of contacts per bag for sale.
2. Both of the solder contacts and the crimp contacts shall be inserted into the inserts of the connectors after soldering the contacts to the cable or crimping the contacts with the cable.

Reel Contact for Semi-Automatic Crimping Machine (Crimping Style Only)

The semi-automatic crimping machine is required when you terminate the reel contacts.

Contact P/N (5,000 pcs on 1 reel)	Applicable Wire		Semi-Automatic Crimping Machine		Extraction Tool P/N
	Conductor Size	Insulation Dia.	1set P/N	Applicator P/N	
CM10-#22SC(C1)(D8)-5000	20 ~ 22AWG	φ 1.10 ~ φ 1.87	AP-A50539T	AP-A50539T-1	357J-50548T
CM10-#22SC(C2)(D8)-5000	23 ~ 28AWG	φ 0.80 ~ φ 1.50	AP-A50540T	AP-A50540T-1	

1. Both of AP50539T and AP50540T are the set part numbers which include both of the semi-automatic crimping machines and the applicators (stripper crimpers).
2. Each of AP50539T and AP50540T contains exactly the same semi-automatic machine.
 Therefore if you change the applicator, you can terminate both of CM10-#22SC(C1)(D8)-5000 and CM10-#22SC(C2)(D8)-5000 by one semi-automatic crimping machine.

CM10-#22SC(C1)(D8)- □□□□

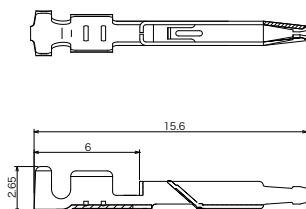

CM10-#22SC(C2)(D8)- □□□□

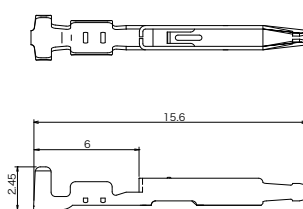

CM10-#22SC(S1)(D8)- □□□□

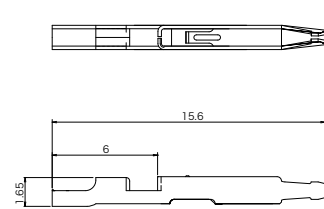

© Specifications and/or dimensions in this catalog are subject to change without notice.
 Your checking the latest specifications with our drawings would be highly appreciated.

<http://www.ddknet.co.jp>

▶ 2-Contact Plug

- Contact Style : Socket
- Termination : Solder or Crimp
- The contact is sold separately.

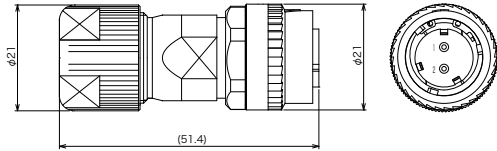
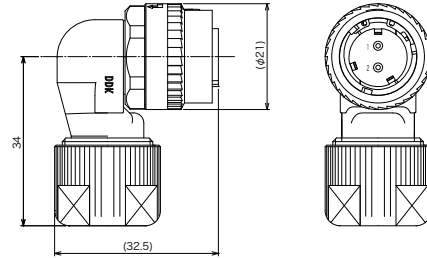
Straight Plug

Right Angle Plug

Straight Plug P/N	Right Angle Plug P/N	Cable Outside Dia.
CM10-SP2S-S(D6)	CM10-AP2S-S(D6)	φ 4.0 ~ φ 6.0
CM10-SP2S-M(D6)	CM10-AP2S-M(D6)	φ 6.0 ~ φ 9.0
CM10-SP2S-L(D6)	CM10-AP2S-L(D6)	φ 9.0 ~ φ 11.6

Note: The applicable cable outside diameter is in the case of cable.
 Please contact the nearest sales office when you use a different cable.
 Regarding the wiring tools, please refer to the instruction manuals attached on the top-page of this connector catalogue.

▶ Contact of 2-Contact Plug

Loose Piece Contact

Item	Contact P/N (100 pcs in 1 bag)	Applicable Wire		Hand Tool P/N	Extraction Tool P/N
		Conductor Size	Insulation Dia.		
Crimping Type	CM10-#22SC(C3)(D8)-100	16 ~ 20AWG	φ 1.87 ~ φ 2.45	357J-50448T	357J-50548T
Soldering Type	CM10-#22SC(S2)(D8)-100	16AWG Max.			

1. The packaging specification is 100 pcs of contacts per bag for sale.
2. Both of the solder contacts and the crimp contacts shall be inserted into the inserts of the connectors after soldering the contacts to the cable or crimping the contacts with the cable.

Reel Contact for Semi-Automatic Crimping Machine (Crimping Style Only)

The semi-automatic crimping machine is required when you terminate the reel contacts.

Contact P/N (4,000 pcs on 1 reel)	Applicable Wire		Semi-Automatic Crimping Machine		Extraction Tool P/N
	Conductor Size	Insulation Dia.	1set P/N	Applicator P/N	
CM10-#22SC(C3)(D8)-4000	16 ~ 20AWG	φ 1.87 ~ φ 2.45	AP-A50541T	AP-A50541T-1	357J-50548T

1. Due to the construction of CM10-#22SC-(C3)(D8)-4000 you can only make the crimping process by AP50541T.
 So the process of stripping cable shall be made in advance.
2. AP50541T is a set part number which includes both of the semi-automatic crimping machine and the applicator (crimper).

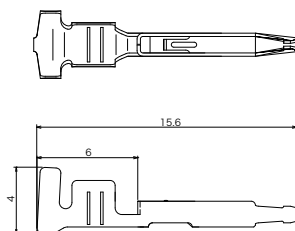
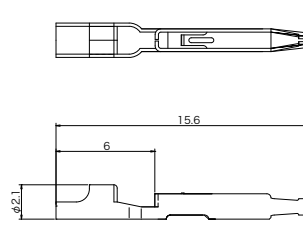
CM10-#22SC(C3)(D8)- □□□□

CM10-#22SC(S2)(D8)- □□□□

▶ Straight Cable Receptacle

10 Pins

P/N	Cable Outside Dia.
CM10-CR10P-S	φ 4.0 ~ φ 6.0
CM10-CR10P-M	φ 6.0 ~ φ 9.0
CM10-CR10P-L	φ 9.0 ~ φ 11.6

- Pin contact style only
- Soldering termination only
- Conductor Size : 20 AWG Max.
- Insulation Dia. : φ 1.87 Max.

· Contact No.10 grounded to shell with ground lug

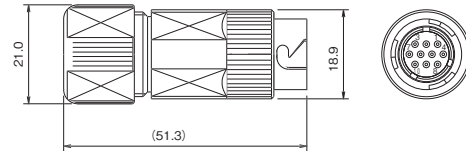

2 Pins

P/N	Cable Outside Dia.
CM10-CR2P-S	φ 4.0 ~ φ 6.0
CM10-CR2P-M	φ 6.0 ~ φ 9.0
CM10-CR2P-L	φ 9.0 ~ φ 11.6

- Pin contact style only
- Soldering termination only
- Conductor Size : 20 AWG Max.

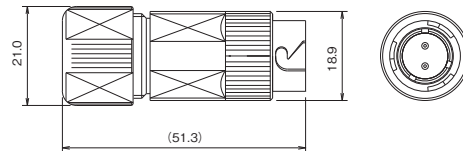

Note: The applicable cable outside diameter is in the case of cabtyre cable. Please contact the nearest sales office when you use a different cable.

▶ Receptacle

10 Pins

P/N
CM10-R10P(D3)-01

- Pin contact style only
- Soldering termination only
- Conductor Size : 20 AWG Max.
- Individually waterproof

2 Pins

P/N
CM10-R2P(D3)-01

- Pin contact style only
- Soldering termination only
- Conductor Size : 20 AWG Max.
- Individually waterproof

Contact No.10 grounded to shell with ground lug

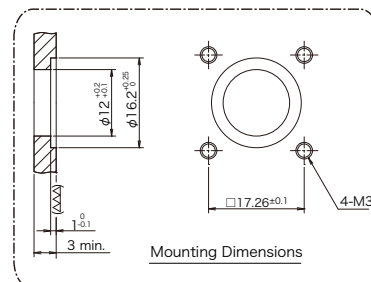
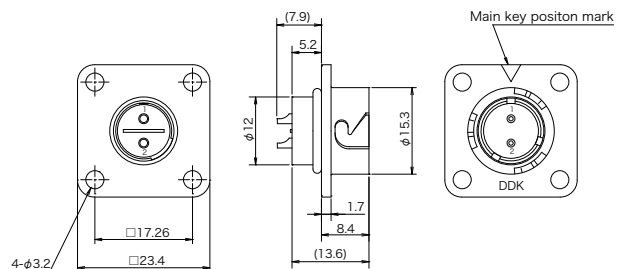
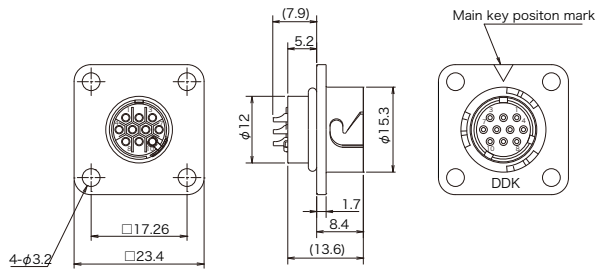

▶ Mated Dimensions

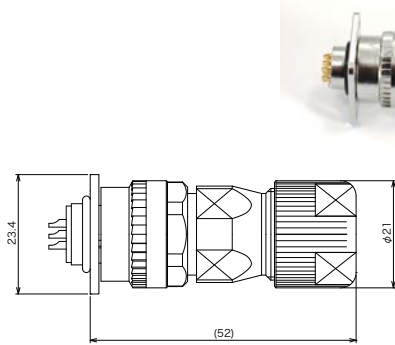
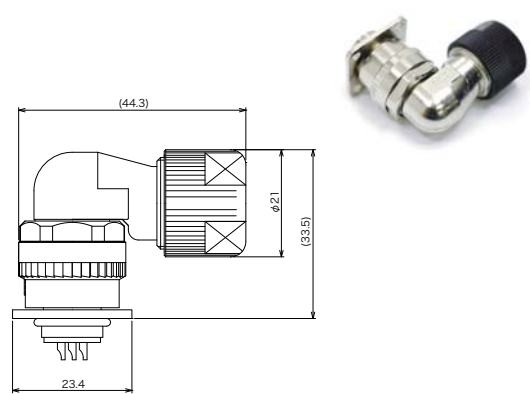
Receptacle + Straight Plug

Receptacle + Right Angle Plug

▶ Dust Cap for Receptacle & Cable Receptacle

P/N
CM10-R-DC

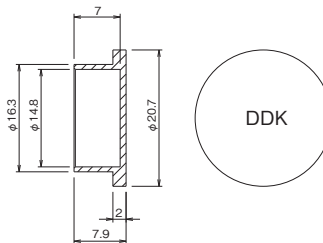
Material : Plastic
Color : Red



▶ Supporting Cover

Straight Plug

P/N
CM10-SP-CV

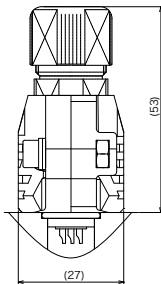
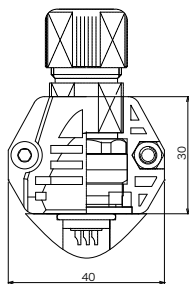
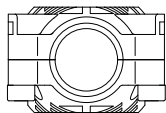
Right Angle Plug

P/N
CM10-AP-D-CV

