

Hyper SIDELED® Enhanced optical Power LED (ATON®)

LW A67C



Vorläufige Daten Preliminary Data

Besondere Merkmale

- **Gehäusetyp:** weißes SMT Gehäuse
- **Besonderheit des Bauteils:** Abstrahlung parallel zur Platine, deshalb ideal zur Einkopplung in Lichtleiter
- **Farbort:** $x = 0,32$, $y = 0,31$ nach CIE 1931 (weiß)
- **typische Farbtemperatur:** 6500 K
- **Farbwiedergabeindex:** 80
- **Abstrahlwinkel:** Lambertscher Strahler (120°)
- **Technologie:** InGaN
- **optischer Wirkungsgrad:** 12 lm/W
- **Gruppierungsparameter:** Lichtstärke, Farbort
- **Verarbeitungsmethode:** für alle SMT-Bestücktechniken geeignet
- **Lötmethode:** IR Reflow Löten und Wellenlöten (TTW)
- **Vorbehandlung:** nach JEDEC Level 2
- **Gurtung:** 12 mm Gurt mit 2000/Rolle, $\varnothing 330$ mm
- **ESD-Festigkeit:** ESD-sicher bis 2 kV nach EOS/ESD-5.1-1993

Anwendungen

- Einkopplung in Lichtleiter
- Hinterleuchtung (LCD, Schalter, Tasten)
- Innenbeleuchtung im Automobilbereich (z.B. Instrumentenbeleuchtung, u.ä.)
- Ersatz von Kleinst-Glühlampen
- Rettungsnotleuchten
- Signal- und Symbolleuchten
- Markierungsbeleuchtung (z.B. Stufen, Fluchtwege, u.ä.)

Features

- **package:** white SMT package
- **feature of the device:** radiation direction parallel to PCB, so an ideal LED for coupling in light guides
- **color coordinates:** $x = 0.32$, $y = 0.31$ acc. to CIE 1931 (white)
- **typ. color temperature:** 6500 K
- **color reproduction index:** 80
- **viewing angle:** Lambertian Emitter (120°)
- **technology:** InGaN
- **optical efficiency:** 12 lm/W
- **grouping parameter:** luminous intensity, color coordinates
- **assembly methods:** suitable for all SMT assembly methods
- **soldering methods:** IR reflow soldering and TTW soldering
- **preconditioning:** acc. to JEDEC Level 2
- **taping:** 12 mm tape with 2000/reel, $\varnothing 330$ mm
- **ESD-withstand voltage:** up to 2 kV acc. to EOS/ESD-5.1-1993

Applications

- coupling into light guides
- backlighting (LCD, switches, keys)
- interior automotive lighting (e.g. dashboard backlighting, etc.)
- substitution of micro incandescent lamps
- emergency lighting
- signal and symbol luminaire
- marker lights (e.g. steps, exit ways, etc.)

Typ	Emissions- farbe	Farbe der Lichtaustritts- fläche	Lichtstärke	Lichtstrom	Bestellnummer
Type	Color of Emission	Color of the Light Emitting Area	Luminous Intensity $I_F = 20 \text{ mA}$ $I_V \text{ (mcd)}$	Luminous Flux $I_F = 20 \text{ mA}$ $\Phi_V \text{ (lm)}$	Ordering Code
LW A67C-S2T2-3C5D	white	colored diffused	224 ... 450	980 (typ.)	Q65110A0516
LW A67C-T2U2-3C5D			355 ... 710	1550 (typ.)	Q65110A0357

Anm.: -3C5D Farbselektiert nach Farbortgruppen (siehe **Seite 5**)

*Die Standardlieferform von Serientypen beinhaltet eine untere bzw. eine obere Familiengruppe, die aus nur 3 bzw. 4 Halbgruppen besteht. Einzelne Halbgruppen sind nicht erhältlich.
In einer Verpackungseinheit / Gurt ist immer nur eine Halbgruppe enthalten.*

Note: -3C5D Color selection acc. to Chromaticity coordinate groups (see **page 5**)

*The standard shipping format for serial types includes a lower or upper family group of 3 or 4 individual groups. Individual half groups are not available.
No packing unit / tape ever contains more than one luminous intensity half group.*

Grenzwerte
Maximum Ratings

Bezeichnung Parameter	Symbol Symbol	Wert Value	Einheit Unit
Betriebstemperatur Operating temperature range	T_{op}	- 40 ... + 100	°C
Lagertemperatur Storage temperature range	T_{stg}	- 40 ... + 100	°C
Sperrschichttemperatur Junction temperature	T_j	+ 110	°C
Durchlassstrom Forward current	I_F	20	mA
Stoßstrom Surge current $t \leq 10 \mu s, D = 0.005$	I_{FM}	300	mA
Sperrspannung ¹⁾ Reverse voltage	V_R	5	V
Leistungsaufnahme Power consumption $T_A \leq 25 \text{ °C}$	P_{tot}	85	mW
Wärmewiderstand Thermal resistance Sperrschicht/Umgebung Junction/ambient	$R_{th JA}$	480	K/W
Sperrschicht/Löt看 Junction/solder point Montage auf PC-Board FR 4 (Padgröße $\geq 16 \text{ mm}^2$) mounted on PC board FR 4 (pad size $\geq 16 \text{ mm}^2$)	$R_{th JS}$	250	K/W

¹⁾ für kurzzeitigen Betrieb geeignet / suitable for short term application

Kennwerte ($T_A = 25\text{ °C}$)

Characteristics

Bezeichnung Parameter	Symbol Symbol	Wert Value	Einheit Unit
Farbkoordinate x nach CIE 1931 ¹⁾ (typ.) Chromaticity coordinate x acc. to CIE 1931 $I_F = 20\text{ mA}$	x	0.32	–
Farbkoordinate y nach CIE 1931 ¹⁾ (typ.) Chromaticity coordinate y acc. to CIE 1931 $I_F = 20\text{ mA}$	y	0.31	–
Abstrahlwinkel bei 50 % I_V (Vollwinkel) (typ.) Viewing angle at 50 % I_V	2ϕ	120	Grad deg.
Durchlassspannung ²⁾ (min.) Forward voltage (typ.) $I_F = 20\text{ mA}$ (max.)	V_F V_F V_F	3.0 3.6 4.1	V V V
Sperrstrom (typ.) Reverse current (max.) $V_R = 5\text{ V}$	I_R I_R	0.01 10	μA μA
Temperaturkoeffizient von x (typ.) Temperature coefficient of x $I_F = 20\text{ mA}; -10\text{ °C} \leq T \leq 100\text{ °C}$	TC_x	–0.1	$10^{-3}/\text{K}$
Temperaturkoeffizient von y (typ.) Temperature coefficient of y $I_F = 20\text{ mA}; -10\text{ °C} \leq T \leq 100\text{ °C}$	TC_y	–0.2	$10^{-3}/\text{K}$
Temperaturkoeffizient von V_F (typ.) Temperature coefficient of V_F $I_F = 20\text{ mA}; -10\text{ °C} \leq T \leq 100\text{ °C}$	TC_V	– 5.0	mV/K
Optischer Wirkungsgrad (typ.) Optical efficiency $I_F = 20\text{ mA}$	η_{opt}	12	lm/W

¹⁾ Farbortgruppen werden mit einer Stromeinprägungsdauer von 25 ms und einer Genauigkeit von $\pm 0,01$ ermittelt.
Chromaticity coordinate groups are tested at a current pulse duration of 25 ms and a tolerance of ± 0.01 .

²⁾ Durchlassspannungswerte werden mit einer Stromeinprägungsdauer von 1 ms und einer Genauigkeit von $\pm 0,1\text{ V}$ ermittelt.
Forward voltage values are tested at a current pulse duration of 1 ms and a tolerance of $\pm 0.1\text{ V}$.

1) Farbortgruppen
Chromaticity coordinate groups

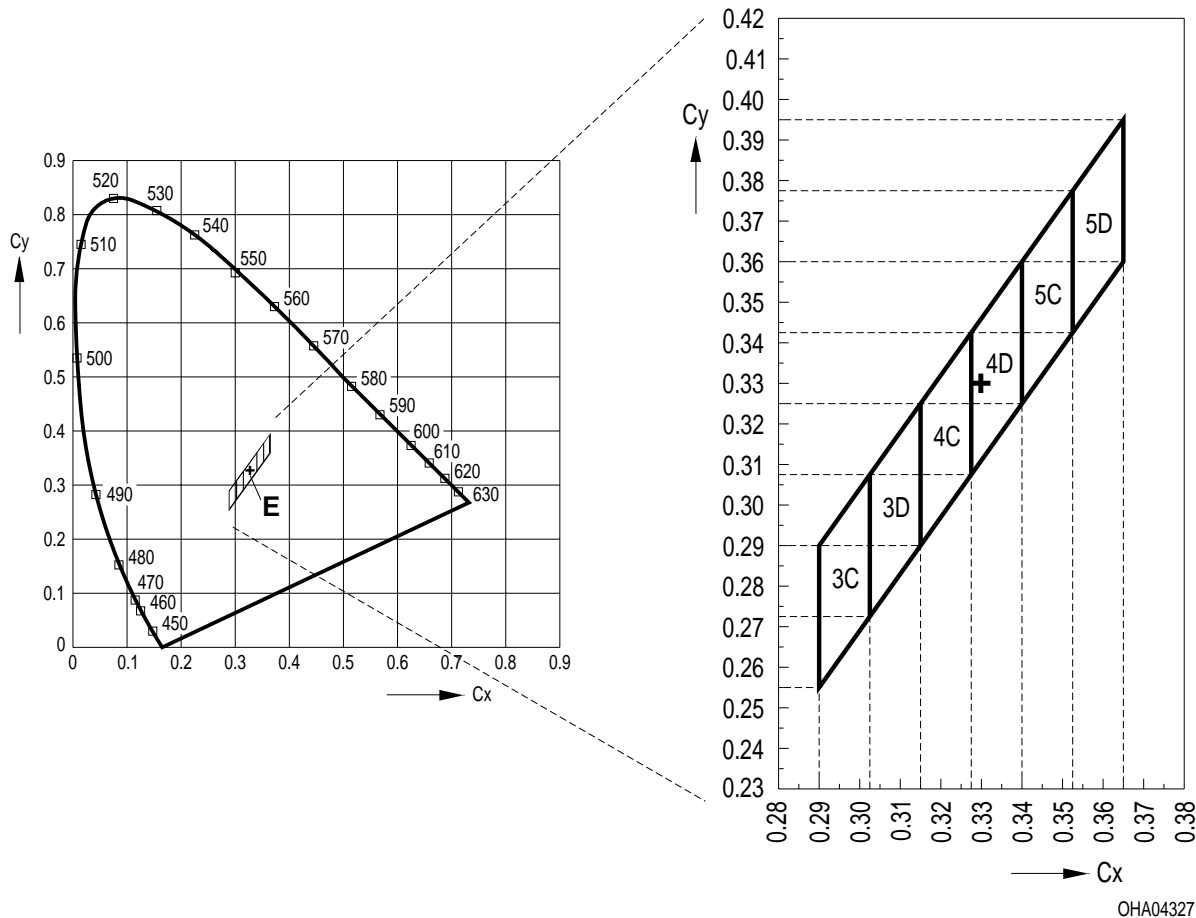

Helligkeits-Gruppierungsschema
Luminous Intensity Groups

Lichtgruppe Luminous Intensity Group	Lichtstärke Luminous Intensity I_V (mcd)	Lichtstrom Luminous Flux Φ_V (mlm)
S2	224 ... 280	760 (typ.)
T1	280 ... 355	950 (typ.)
T2	355 ... 450	1200 (typ.)
U1	450 ... 560	1500 (typ.)
U2	560 ... 710	1900 (typ.)

Helligkeitswerte werden mit einer Stromeinprägedauer von 25 ms und einer Genauigkeit von $\pm 11\%$ ermittelt.
 Luminous intensity is tested at a current pulse duration of 25 ms and a tolerance of $\pm 11\%$.

Gruppenbezeichnung auf Etikett
Group Name on Label

Beispiel: S2-4C

Example: S2-4C

Lichtgruppe Luminous Intensity Group	Halbgruppe Half Group	Farbortgruppe Chromaticity Coordinate Group
S	2	4C

Relative spektrale Emission $I_{rel} = f(\lambda)$, $T_A = 25\text{ °C}$, $I_F = 20\text{ mA}$

Relative Spectral Emission

$V(\lambda)$ = spektrale Augenempfindlichkeit

Standard eye response curve

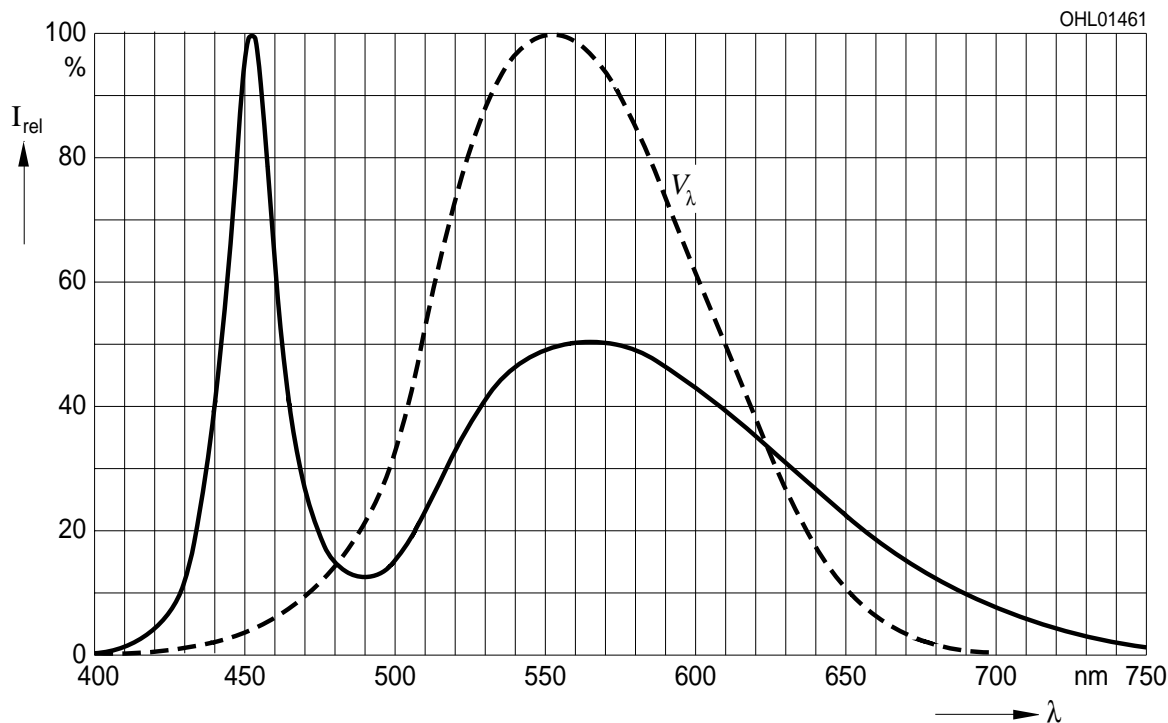

Abstrahlcharakteristik $I_{rel} = f(\varphi)$

Radiation Characteristic

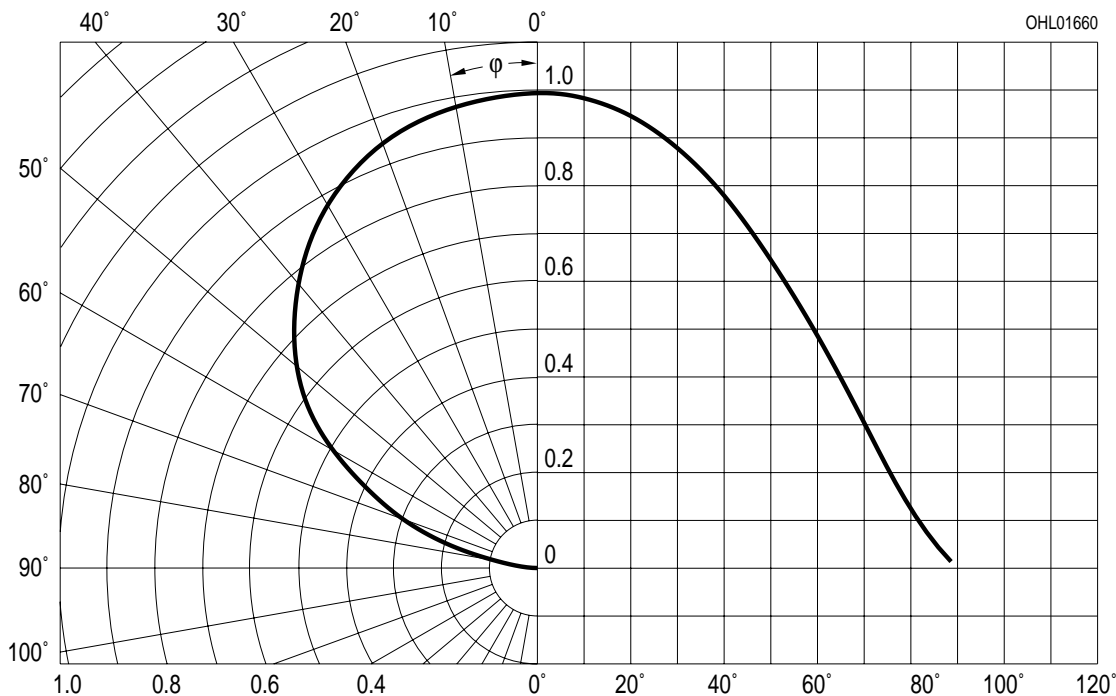

Durchlassstrom $I_F = f(V_F)$

Forward Current

$T_A = 25\text{ °C}$

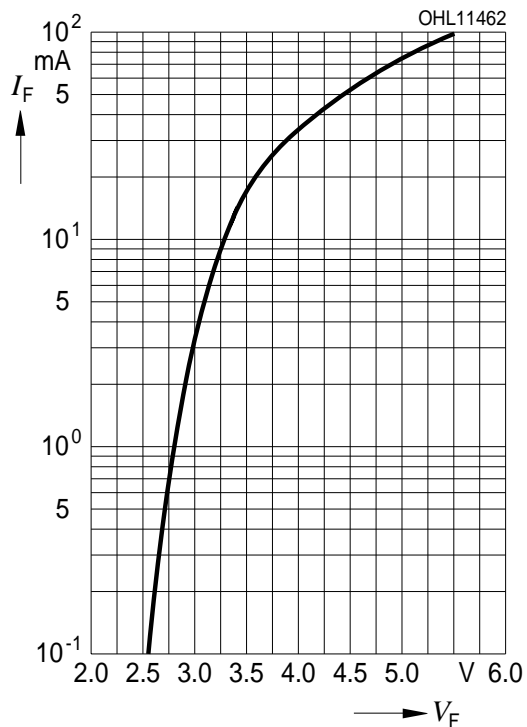

Relative Lichtstärke $I_V/I_{V(20\text{ mA})} = f(I_F)$

Relative Luminous Intensity

$T_A = 25\text{ °C}$

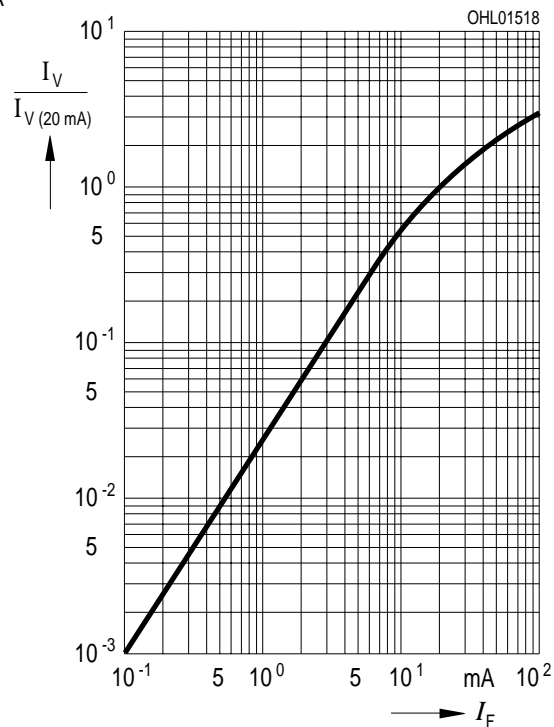

Maximal zulässiger Durchlassstrom $I_F = f(T)$

Max. Permissible Forward Current

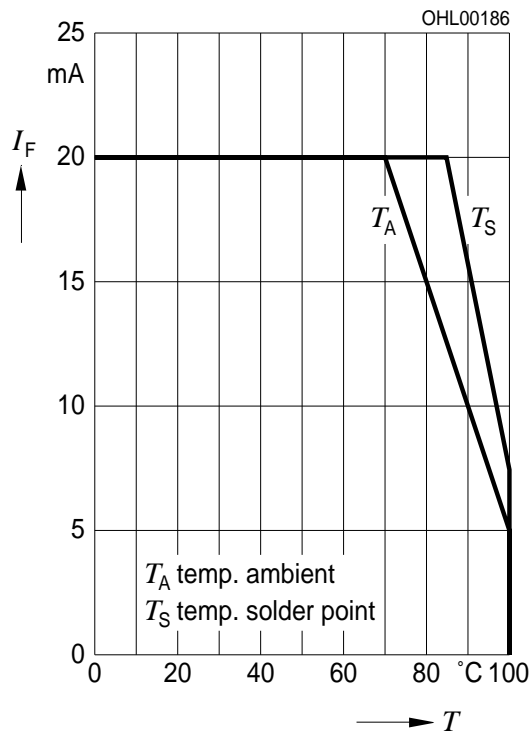

Relative Lichtstärke $I_V/I_{V(25\text{ °C})} = f(T_A)$

Relative Luminous Intensity

$I_F = 20\text{ mA}$

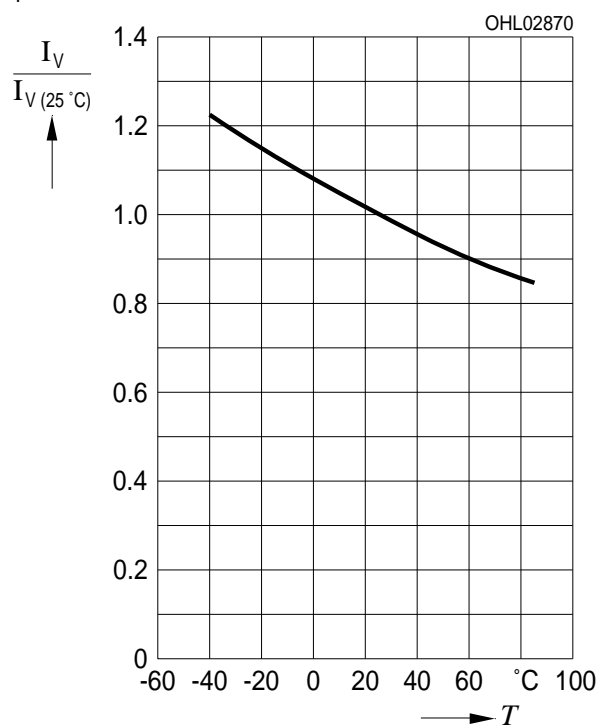

Zulässige Impulsbelastbarkeit $I_F = f(t_p)$
Permissible Pulse Handling Capability
 Duty cycle $D =$ parameter, $T_A = 25\text{ °C}$

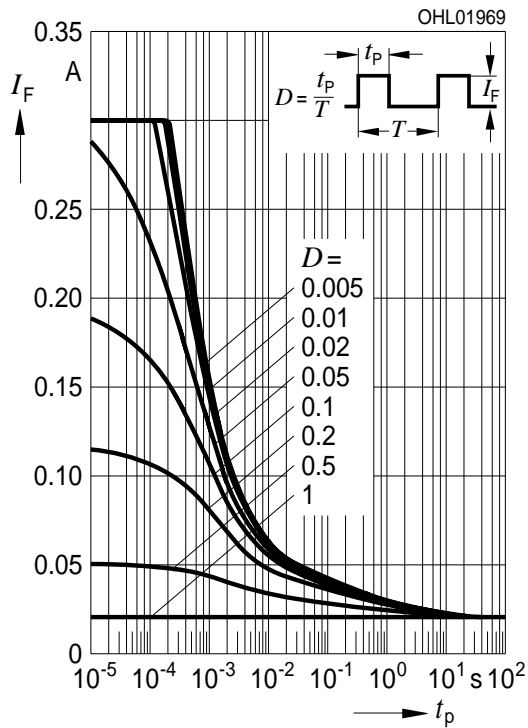

Zulässige Impulsbelastbarkeit $I_F = f(t_p)$
Permissible Pulse Handling Capability
 Duty cycle $D =$ parameter, $T_A = 85\text{ °C}$

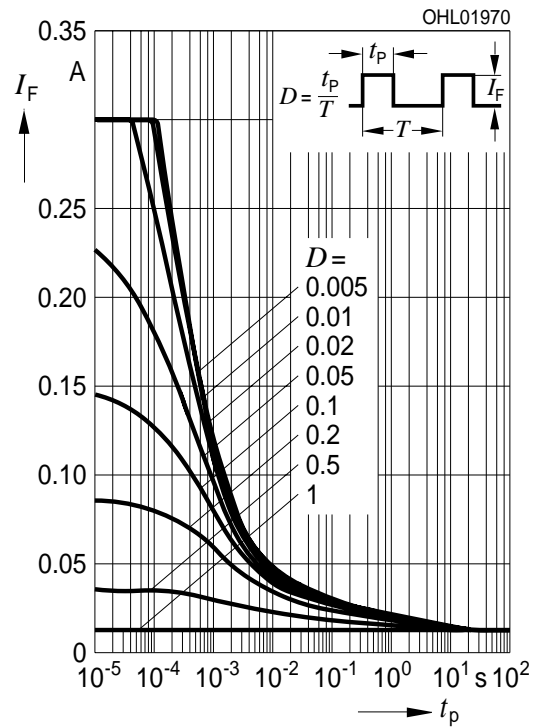

Farbortverschiebung $x, y = f(I_F)$
Chromaticity Coordinate Shift
 $T_A = 25\text{ °C}$

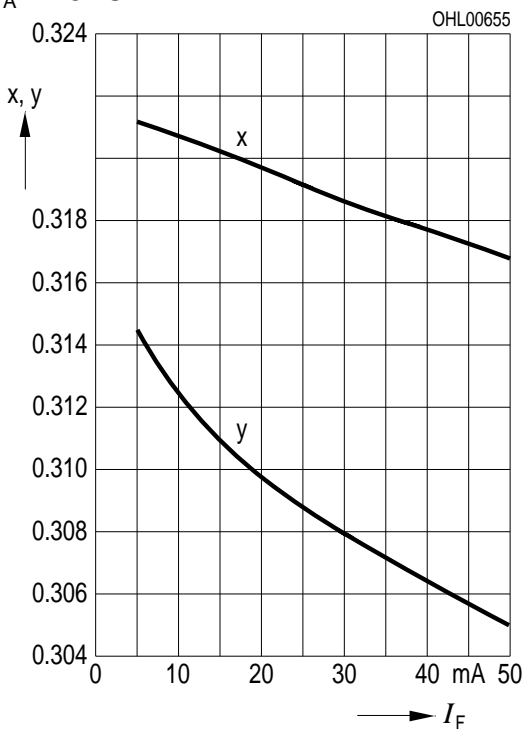

Maßzeichnung
Package Outlines

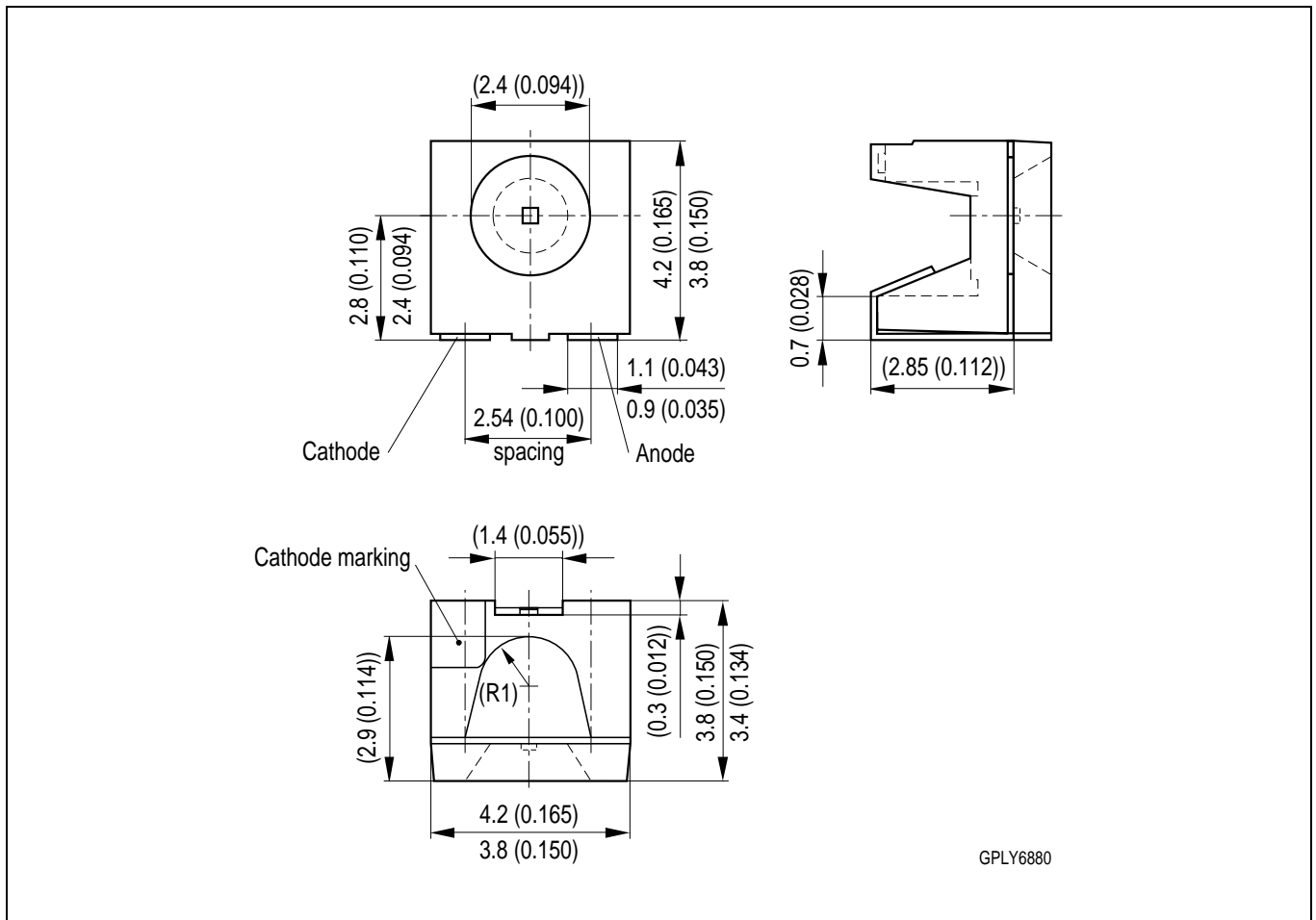

Maße werden wie folgt angegeben: mm (inch) / Dimensions are specified as follows: mm (inch).

Kathodenkennung: abgeschrägte Ecke

Cathode mark: bevelled edge

Gewicht / Approx. weight: 40 mg

Lötbedingungen Vorbehandlung nach JEDEC Level 2
Soldering Conditions Preconditioning acc. to JEDEC Level 2

IR-Reflow Lötprofil (nach IPC 9501)
IR Reflow Soldering Profile (acc. to IPC 9501)

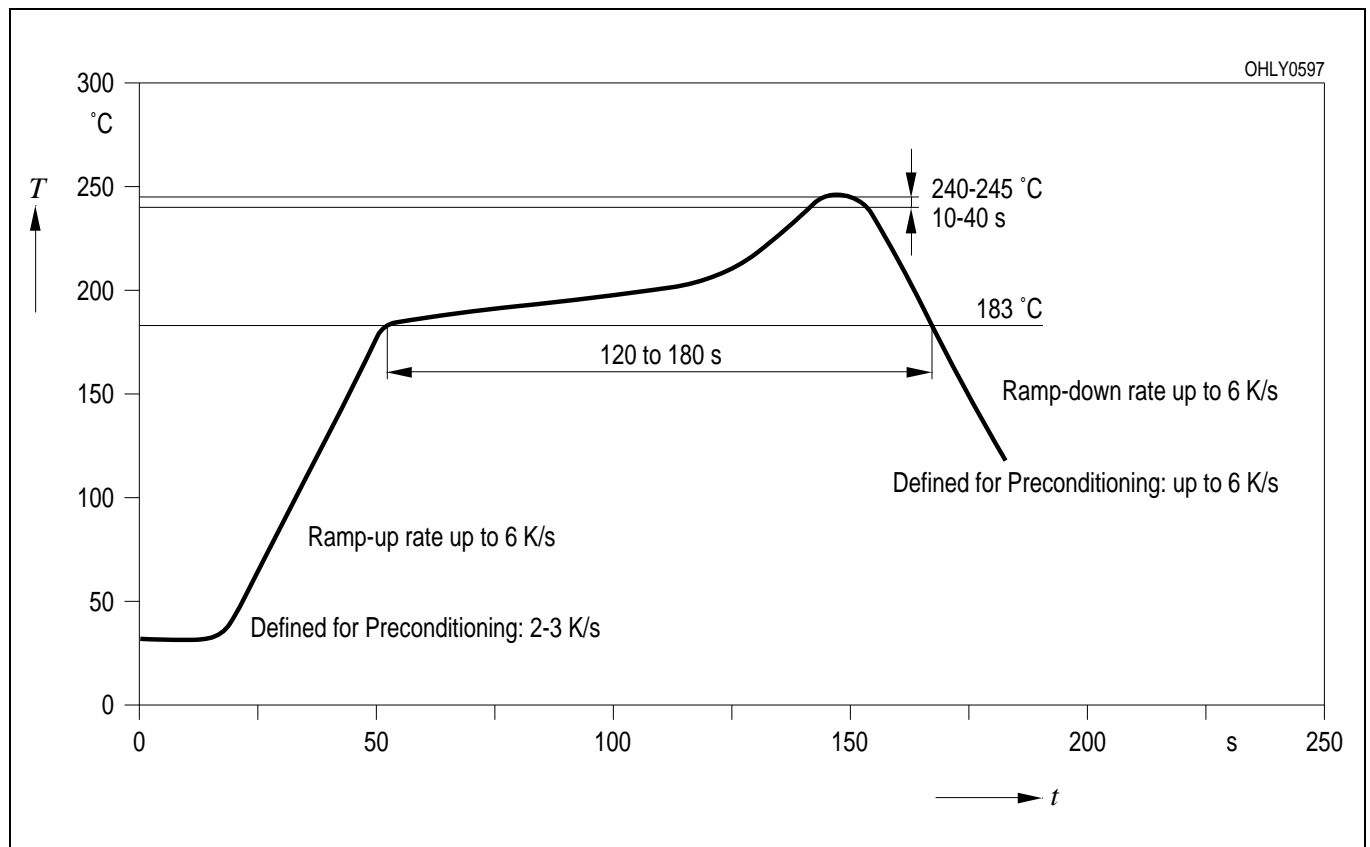

Wellenlötten (TTW) (nach CECC 00802)
TTW Soldering (acc. to CECC 00802)

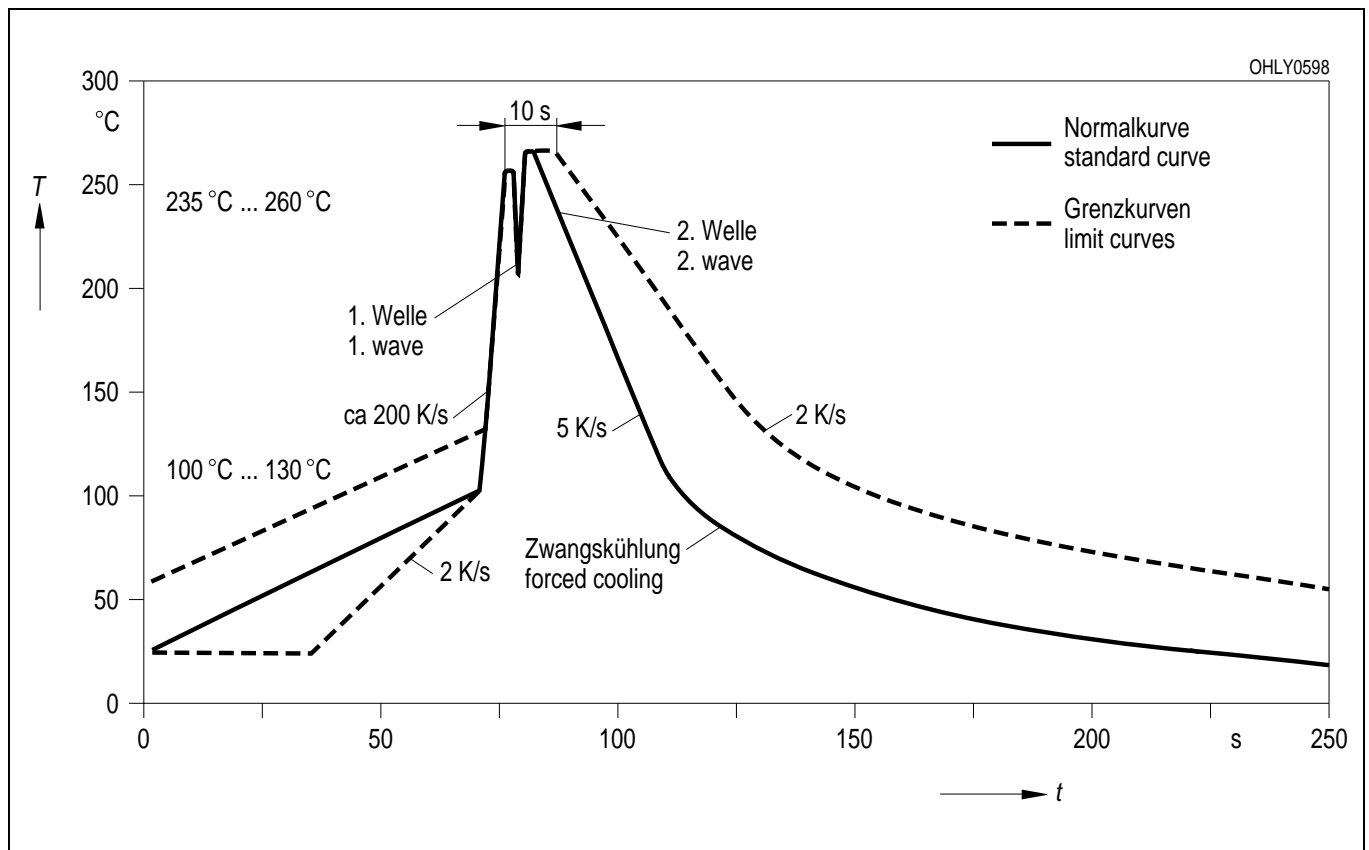

Empfohlenes Lötpad Design Wellenlöten (TTW)
Recommended Solder Pad TTW Soldering

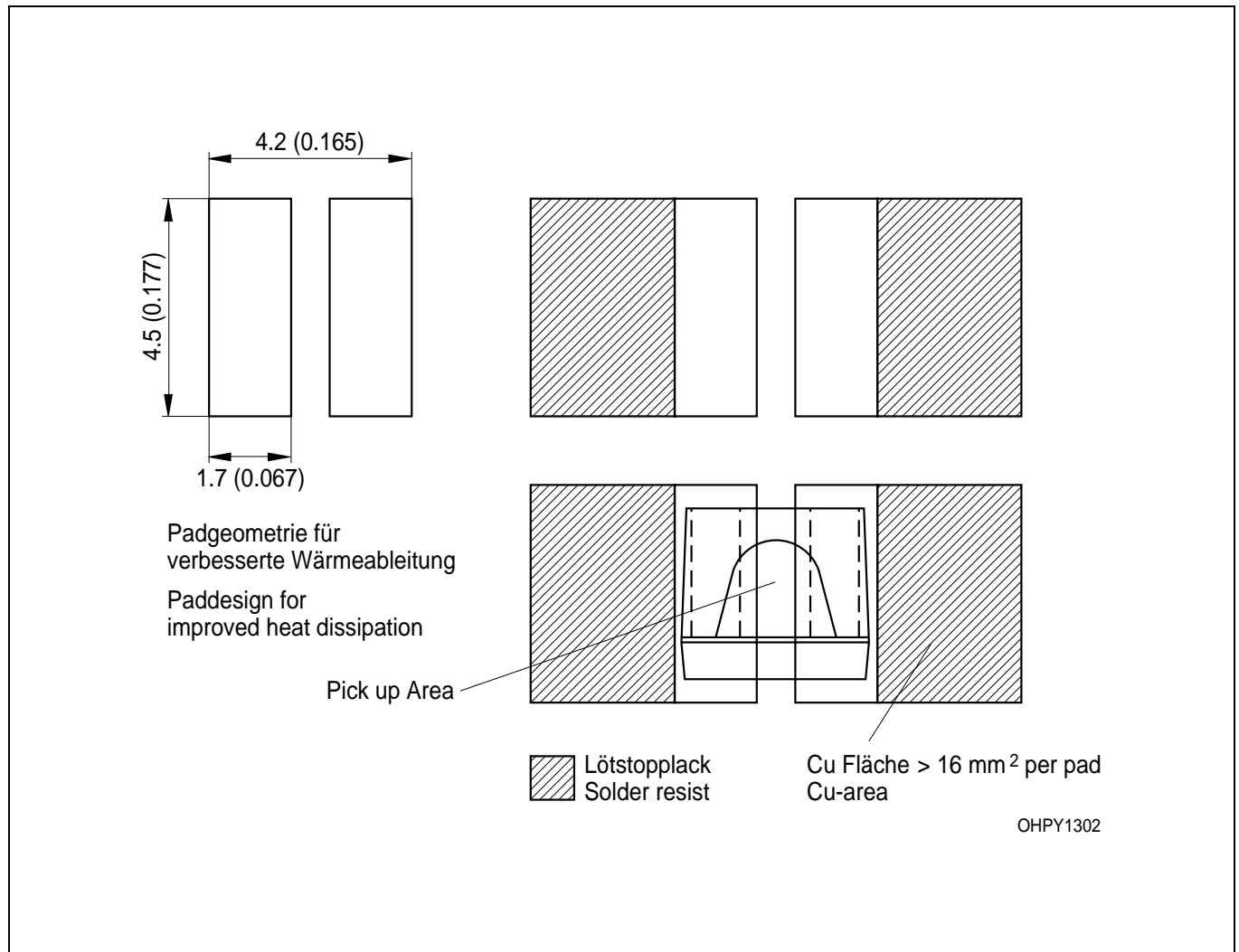

Maße werden wie folgt angegeben: mm (inch) / Dimensions are specified as follows: mm (inch).

Empfohlenes Lötpad Design IR Reflow Lötten
Recommended Solder Pad IR Reflow Soldering

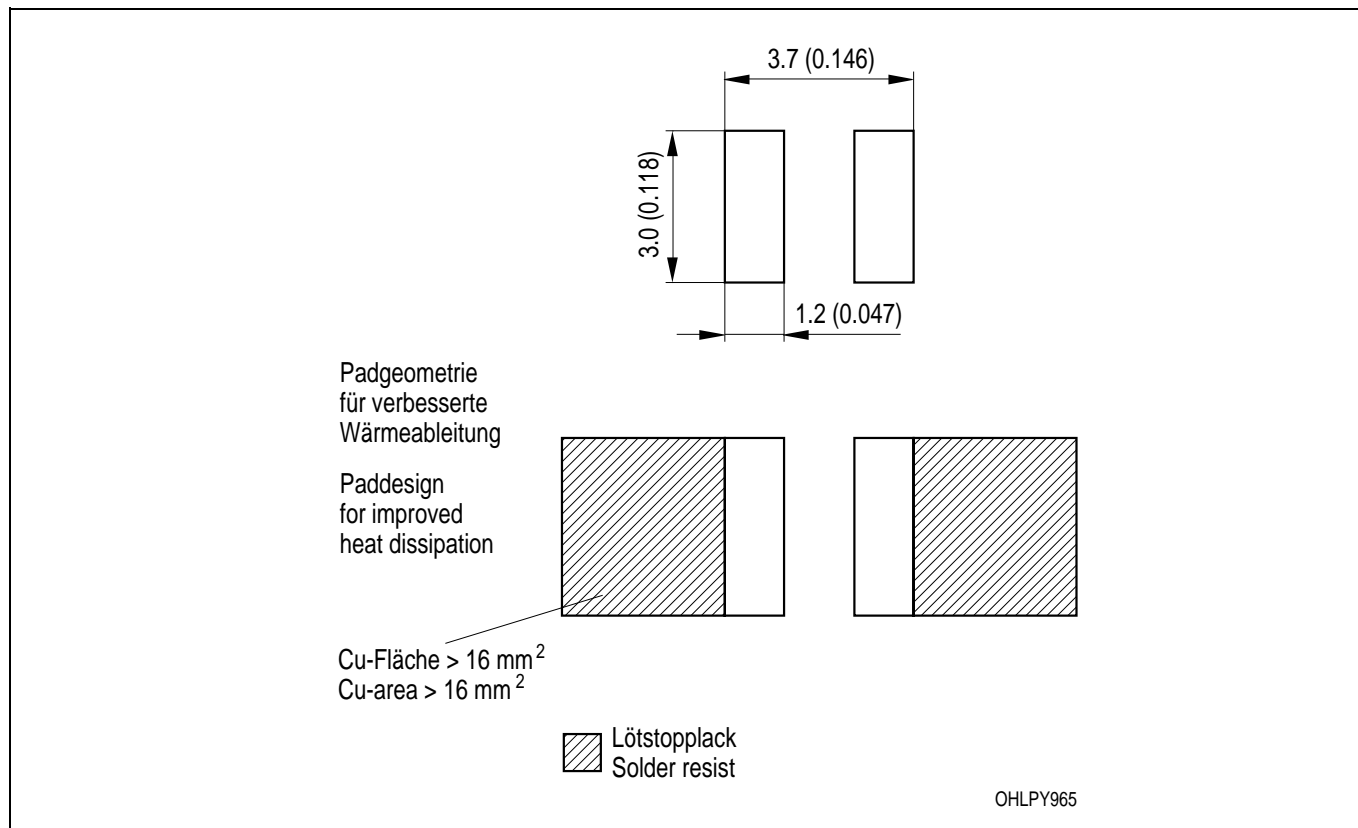

Maße werden wie folgt angegeben: mm (inch) / Dimensions are specified as follows: mm (inch).

Gurtung / Polarität und Lage Verpackungseinheit 2000/Rolle, ø330 mm
Method of Taping / Polarity and Orientation Packing unit 2000/reel, ø330 mm

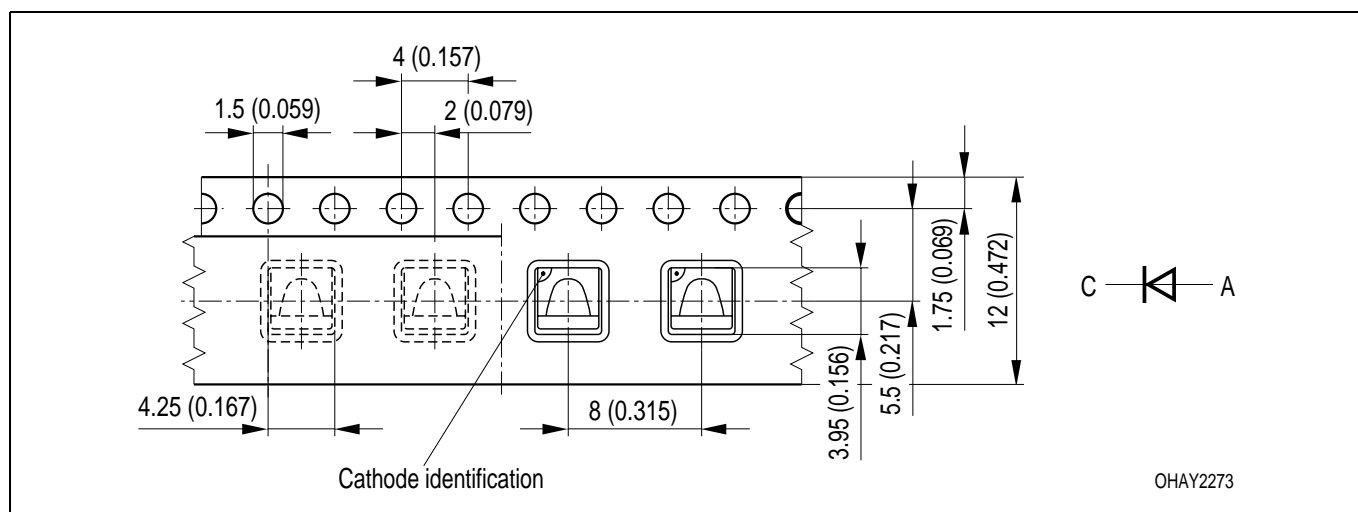

Maße werden wie folgt angegeben: mm (inch) / Dimensions are specified as follows: mm (inch).

Revision History: 2003-06-26		Date of change
Previous Version: 2003-06-02		
Page	Subjects (major changes since last revision)	
13	recommended solder pad (TTW)	
4	value (forward voltage)	
3	power consumption from 90 mW to 85 mW	
8	diagram luminous intensity from OHL01462 to OHL11462	
5	color coordinate grouping for white	
2	color coordinate grouping / luminous intensity grouping	
15	annotations	2002-07-25
14	recomm. solder pad (IR reflow soldering) from OHLPY975 to OHLPY965	2002-08-01
3	reverse voltage (footnote)	2002-08-21
2, 5	new luminous intensity groups and new ordering codes	2002-10-25
15	new patent no.	2003-03-04
all	PCN data sheet	2003-03-20
8	new diagram permissible forward current	2003-06-02
9	new pulse derating	2003-06-26

Patent List

Patent No.

US 6 066 861, US 5 035 483, US 6 277 301, US 6 245 259

Published by OSRAM Opto Semiconductors GmbH

Wernerwerkstrasse 2, D-93049 Regensburg

© All Rights Reserved.

Attention please!

The information describes the type of component and shall not be considered as assured characteristics. All typical data and graphs are basing on representative samples, but don't represent the production range. If requested, e.g. because of technical improvements, these typ. data will be changed without any further notice.

Terms of delivery and rights to change design reserved. Due to technical requirements components may contain dangerous substances. For information on the types in question please contact our Sales Organization.

If printed or downloaded, please find the latest version in the Internet.

Packing

Please use the recycling operators known to you. We can also help you – get in touch with your nearest sales office. By agreement we will take packing material back, if it is sorted. You must bear the costs of transport. For packing material that is returned to us unsorted or which we are not obliged to accept, we shall have to invoice you for any costs incurred.

Components used in life-support devices or systems must be expressly authorized for such purpose! Critical components ¹ may only be used in life-support devices or systems ² with the express written approval of OSRAM OS.

¹ A critical component is a component used in a life-support device or system whose failure can reasonably be expected to cause the failure of that life-support device or system, or to affect its safety or the effectiveness of that device or system.

² Life support devices or systems are intended (a) to be implanted in the human body, or (b) to support and/or maintain and sustain human life. If they fail, it is reasonable to assume that the health of the user may be endangered.