

# SANMOTION F

## STEPPING SYSTEMS

### 2相ステッピングモータ 2-Phase Stepping Motor



高トルク42mm角タイプ0.9°ステッピングモータ  
新ラインナップ

High-Torque NEMA 17-0.9°Stepping-Motor  
New lineup

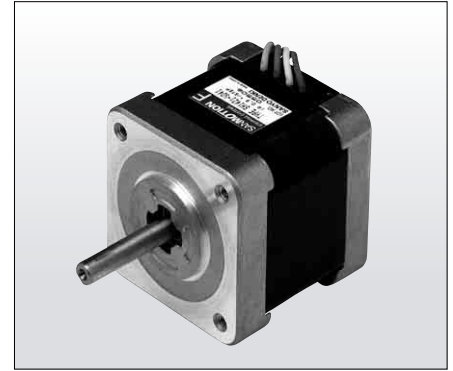

□ **42mm** 0.9°/ステップ バイポーラ巻線 0.9°/step Bipolar winding

■ 仕様 Specifications

型番 Model		ホールディングトルク 2相励磁時 Holding torque at 2-phase energization	定格電流 Rated current	巻線抵抗 Resistance	巻線インダクタンス Inductance	ローターイナーシャ Rotor inertia	質量 Mass
片軸 Single shaft	両軸 Double shafts	N·m以上 [N·m(oz·in) MIN.]	A/相 [A/phase]	Ω/相 [Ω/phase]	mH/相 [mH/phase]	×10 <sup>-4</sup> kg·m <sup>2</sup> (oz·in <sup>2</sup> )	kg (lbs)
SH1421-5041	-5011	0.23(32.5)	1	3.3	8.0	0.044(0.24)	0.24(0.53)
SH1421-5241	-5211	0.23(32.5)	2	0.85	2.1	0.044(0.24)	0.24(0.53)
SH1422-5041	-5011	0.34(48.1)	1	4.0	14.0	0.066(0.36)	0.29(0.64)
SH1422-5241	-5211	0.34(48.1)	2	1.05	3.6	0.066(0.36)	0.29(0.64)
SH1424-5041	-5011	0.48(67.9)	1	4.7	15.0	0.089(0.49)	0.38(0.84)
SH1424-5241	-5211	0.48(67.9)	2	1.25	3.75	0.089(0.49)	0.38(0.84)

■ パルスレート-トルク特性 Pulse rate-torque characteristics

共通駆動条件 Common driving conditions

山洋定電流駆動回路 励磁方式:2相励磁(フルステップ)

電源電圧:24VDC JL:0.94×10<sup>-4</sup>kg·m<sup>2</sup>(ラバーカップリング使用)

巻線電流:1A/相 (SH1421-50□□, SH1422-50□□, SH1424-50□□)

巻線電流:2A/相 (SH1421-52□□, SH1422-52□□, SH1424-52□□)

fs:無負荷時の最大自起動周波数

Sanyo constant current circuit Driving method : 2-phase energization (full-step)

Source voltage : 24VDC JL=0.94X10<sup>-4</sup> kg · m<sup>2</sup> [5.14 oz · in<sup>2</sup>](Use the rubber coupling)

Operating current : 1A/phase (SH1421-50□□, SH1422-50□□, SH1424-50□□)

Operating current : 2A/phase (SH1421-52□□, SH1422-52□□, SH1424-52□□)

fs:No load maximum starting pulse rate

SH1421-5041 (片軸 Single shaft)  
SH1421-5011 (両軸 Double shafts)

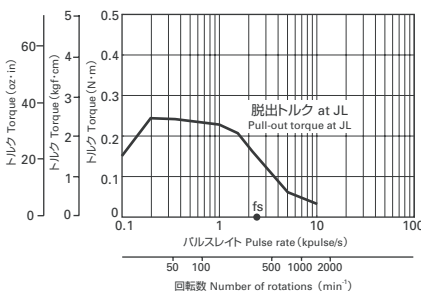

SH1422-5041 (片軸 Single shaft)  
SH1422-5011 (両軸 Double shafts)

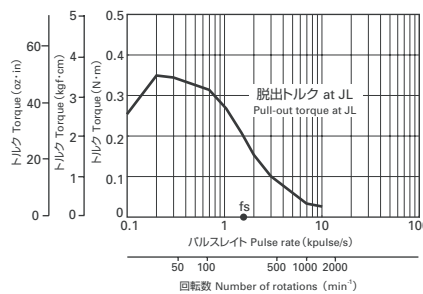

SH1424-5041 (片軸 Single shaft)  
SH1424-5011 (両軸 Double shafts)

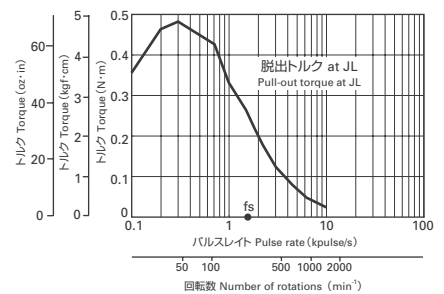

SH1421-5241 (片軸 Single shaft)  
SH1421-5211 (両軸 Double shafts)

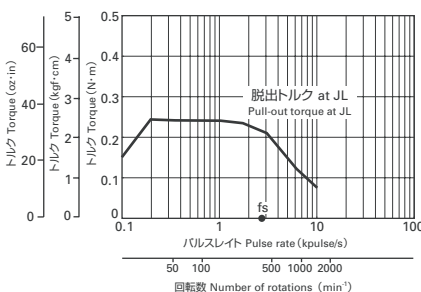

SH1422-5241 (片軸 Single shaft)  
SH1422-5211 (両軸 Double shafts)

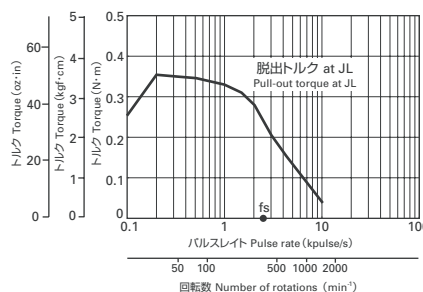

SH1424-5241 (片軸 Single shaft)  
SH1424-5211 (両軸 Double shafts)

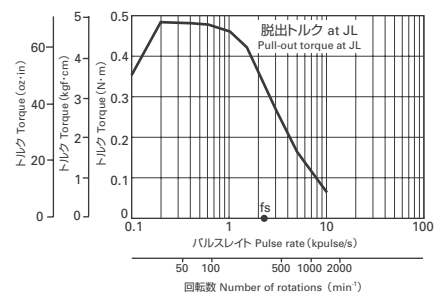

■ 外形図 単位:mm Dimensions Unit: mm (inch)

SH1421-□□41 (片軸 Single shaft)

SH1421-□□11 (両軸 Double shafts)

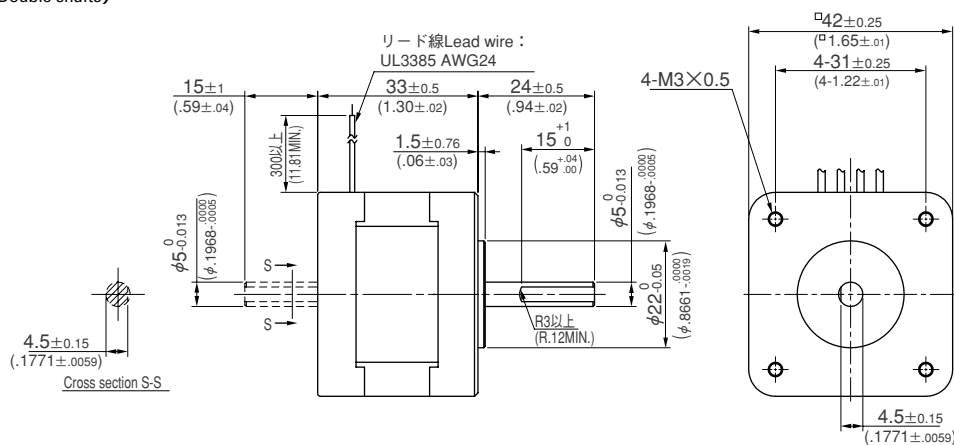

SH1422-□□41 (片軸 Single shaft)

SH1422-□□11 (両軸 Double shafts)

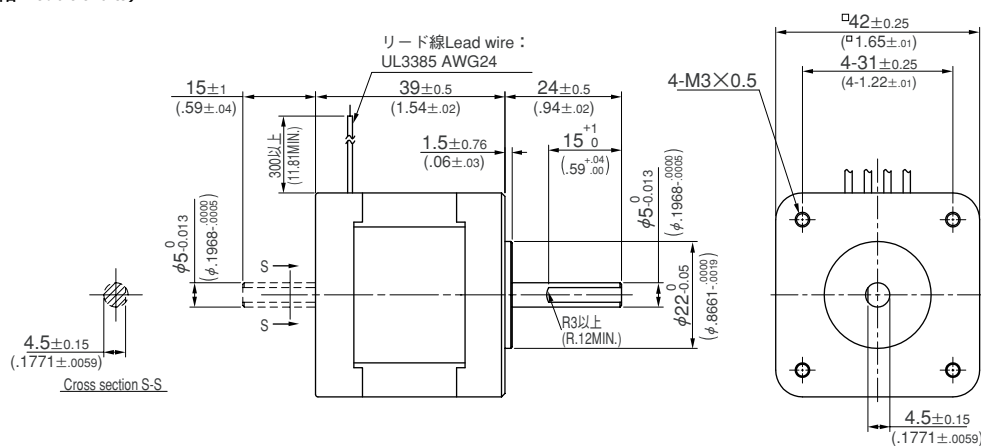

SH1424-□□41 (片軸 Single shaft)

SH1424-□□11 (両軸 Double shafts)

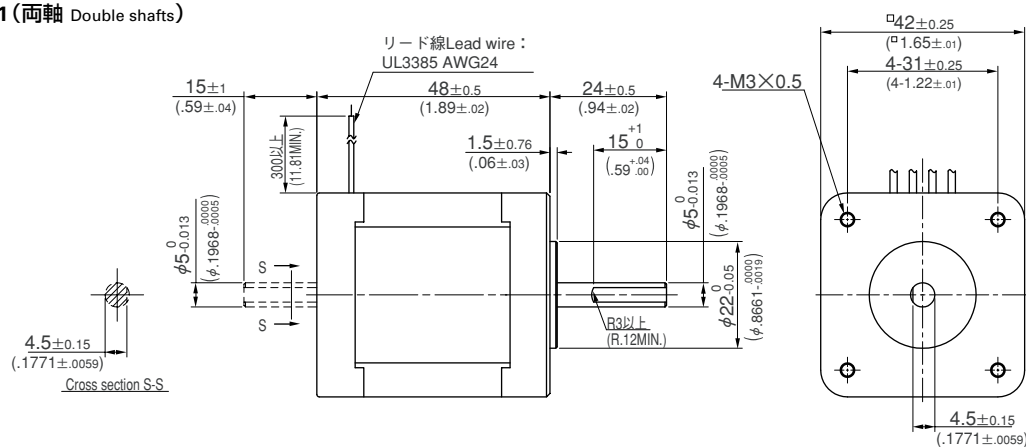

ご採用にあたっての注意事項 Notice

- 本カタログ掲載の製品は、輸出貨物管理令別表第一の16の項に掲げる貨物に該当します。輸出に際しては、キャッチオール規制に基づくインフォーム要件「客観要件」の検討と併せ、監督官庁に対し輸出手続の実施をお願いします。
- The products shown in the catalog are subject to Japanese Export Control Law. Diversion contrary to the law of exporting country is prohibited.

山洋電気株式会社  
SANYO DENKI CO., LTD.

本社 〒170-8451 東京都豊島区北大塚1-15-1 電話(03) 3917 5151(大代) / Headquarters 1-15-1, KITA OTSUKA, TOSHIMA-KU, TOKYO, JAPAN Phone : +81 3 3917 2223 Fax : +81 3 3917 4521

Home Page:<http://www.sanyodenki.co.jp>