



U7SH02

CMOS IC

2-INPUT NOR GATE

DESCRIPTION

The U7SH02 is a 2-input NOR gate, it provides the function $Y = \overline{A+B}$
This device has power-down protective circuit, preventing device destruction when it is powered down.

FEATURES

- * Operation voltage range: 2~5.5V
- * Low power dissipation: $I_{CC}=2\mu A(\text{Max})$
- * High speed: $t_{pd}=3.8\text{ns}(\text{Typ})$
- * High noise immunity
- * Power down protection

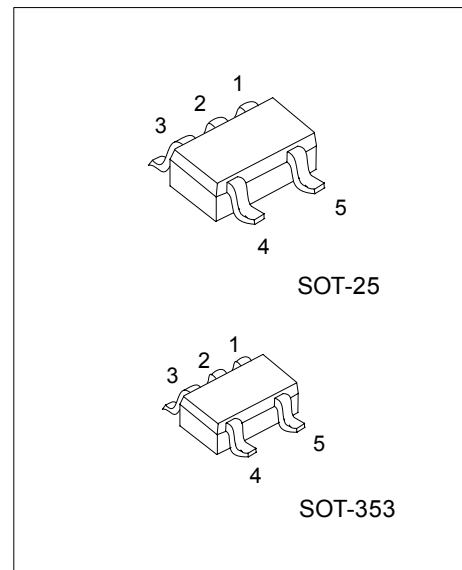

*Pb-free plating product number: U7SH02L

ORDERING INFORMATION

Order Number		Package	Packing
Normal	Lead Free Plating		
U7SH02-AF5-R	U7SH02L-AF5-R	SOT-25	Tape Reel
U7SH02-AL5-R	U7SH02L-AL5-R	SOT-353	Tape Reel

<p>U7SH02L-AF5-R</p> <p>(1)Packing Type (2)Package Type (3)Lead Plating</p>	<p>(1) R: Tape Reel (2) AF5: SOT-25, AL5: SOT-353 (3) L: Lead Free Plating, Blank: Pb/Sn</p>
---	--

MARKING

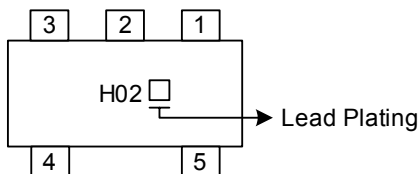

■ PIN CONFIGURATION

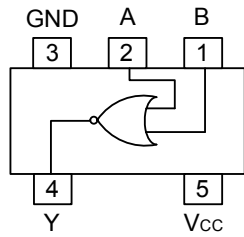

■ FUNCTION TABLE (each gate)

INPUT		OUTPUT
A	B	Y
L	L	H
L	H	L
H	L	L
H	H	L

■ LOGIC DIAGRAM (positive logic)

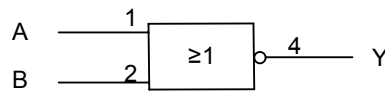
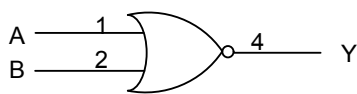

■ ABSOLUTE MAXIMUM RATINGS (unless otherwise specified)(Note 1)

PARAMETER	SYMBOL	RATINGS	UNIT
Supply Voltage	V _{CC}	-0.5~7	V
Input Voltage	V _{IN}	-0.5~7	V
Output Voltage	V _{OUT}	-0.5~V _{CC} +0.5	V
Input Clamp Current	I _{IK}	-20	mA
Output Clamp Current	I _{OK}	±20	mA
Output Current	I _{OUT}	±25	mA
V _{CC} or GND Current	I _{CC}	±50	mA
Power Dissipation	P _D	200	mW
Storage Temperature	T _{STG}	-65 ~ +150	

Note 1. The input and output voltage ratings may be exceeded if the input and output current ratings are observed.

2. Absolute maximum ratings are those values beyond which the device could be permanently damaged.

Absolute maximum ratings are stress ratings only and functional device operation is not implied.

■ RECOMMENDED OPERATING CONDITIONS

PARAMETER	SYMBOL	CONDITIONS	MIN	TYP	MAX	UNIT
Supply Voltage	V _{CC}		2		5.5	V
Input Voltage	V _{IN}		0		5.5	V
Output Voltage	V _{OUT}		0		V _{CC}	V
Input Transition Rise or Fall Rate	Δt/ΔV	V _{CC} =3.3+0.3V			100	ns/V
		V _{CC} =5.0+0.5V			20	
Operating Temperature	T _A		-40		85	

■ STATIC CHARACTERISTICS (Ta=25)

PARAMETER	SYMBOL	TEST CONDITIONS	MIN	TYP	MAX	UNIT
High-Level Input Voltage	V _{IH}	V _{CC} =2.0V	1.5			V
		V _{CC} =3.0V	2.1			
		V _{CC} =5.5V	3.85			
Low-Level Input Voltage	V _{IL}	V _{CC} =2.0V			0.5	V
		V _{CC} =3.0V			0.9	
		V _{CC} =5.5V			1.65	
High-Level Output Voltage	V _{OH}	V _{CC} =2.0V, I _{OH} =-50μA	1.9	2.0		V
		V _{CC} =3.0V, I _{OH} =-50μA	2.9	3.0		
		V _{CC} =4.5V, I _{OH} =-50μA	4.4	4.5		
		V _{CC} =3.0V, I _{OH} =-4mA	2.58			
		V _{CC} =4.5V, I _{OH} =-8mA	3.94			
Low-Level Output Voltage	V _{OL}	V _{CC} =2.0V, I _{OL} =50μA			0.1	V
		V _{CC} =3.0V, I _{OL} =50μA			0.1	
		V _{CC} =4.5V, I _{OL} =50μA			0.1	
		V _{CC} =3.0V, I _{OH} =4mA			0.36	
		V _{CC} =4.5V, I _{OH} =8mA			0.36	
Input Leakage Current	I _{I(LEAK)}	V _{CC} =0V~ 5.5V, V _{IN} =V _{CC} or GND			±0.1	μA
Quiescent Supply Current	I _Q	V _{CC} =5.5V, V _{IN} =V _{CC} or GND, I _{OUT} =0			2	μA
Input Capacitance	C _{IN}	V _{CC} =5V, V _{IN} =V _{CC} or GND		4	10	pF

■ DYNAMIC CHARACTERISTICS (Ta=25 , Input: tr, tf=3ns)

PARAMETER	SYMBOL	TEST CONDITIONS	MIN	TYP	MAX	UNIT
Propagation delay from input (A or B) to output(Y)	t _{PLH}	V _{CC} =3.3V±0.3V, C _L =15 pF		5.5	7.9	ns
	t _{PHL}			5.5	7.9	
	t _{PLH}	V _{CC} =3.3V±0.3V, C _L =50 pF		8.0	11.4	
	t _{PHL}			8.0	11.4	
Propagation delay from input (A or B) to output(Y)	t _{PLH}	V _{CC} = 5V±0.5V, C _L =15 pF		3.8	5.5	ns
	t _{PHL}			3.8	5.5	
	t _{PLH}	V _{CC} = 5V±0.5V, C _L =50 pF		5.3	10	
	t _{PHL}			5.3	10	
OPERATING CHARACTERISTICS						
Power Dissipation Capacitance	C _{pd}	No load		15		pF

■ TEST CIRCUIT AND WAVEFORM

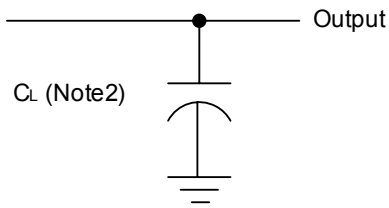

Note 2: CL includes probe and jig capacitance.

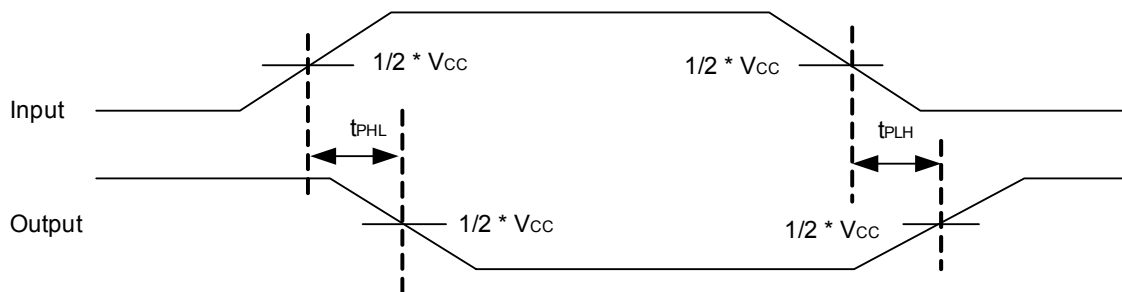

UTC assumes no responsibility for equipment failures that result from using products at values that exceed, even momentarily, rated values (such as maximum ratings, operating condition ranges, or other parameters) listed in products specifications of any and all UTC products described or contained herein. UTC products are not designed for use in life support appliances, devices or systems where malfunction of these products can be reasonably expected to result in personal injury. Reproduction in whole or in part is prohibited without the prior written consent of the copyright owner. The information presented in this document does not form part of any quotation or contract, is believed to be accurate and reliable and may be changed without notice.