

Abdeckung vorverrastet
cover loose mounted

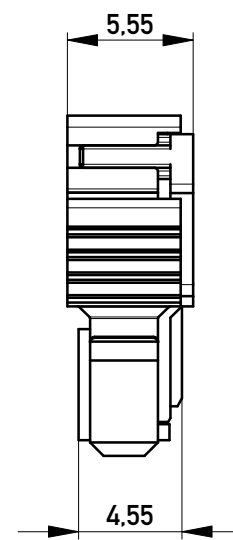

Abdeckung verpresst
cover pressed on

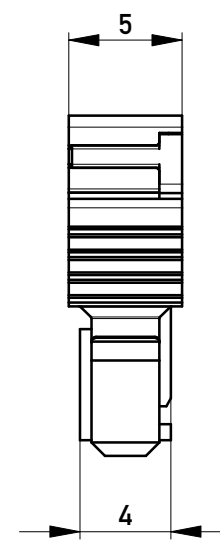

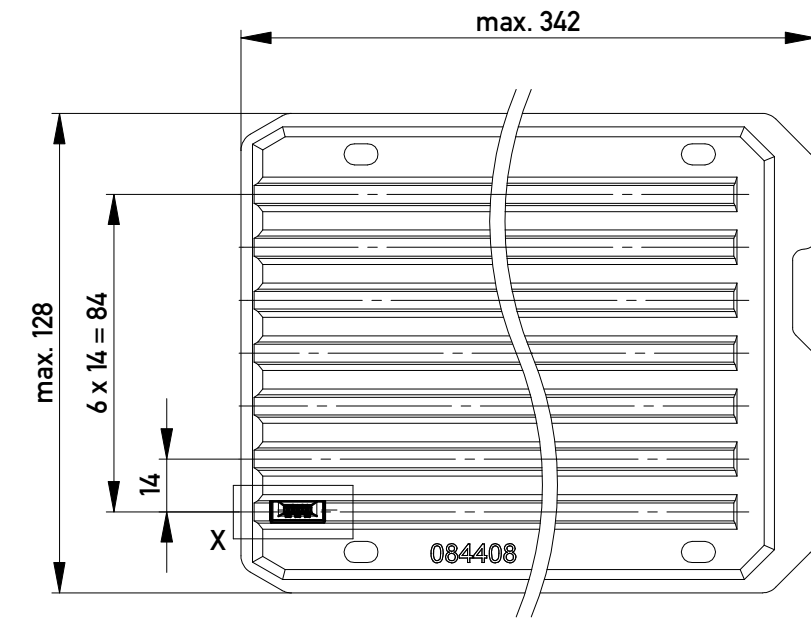

Verpackt in Tray - tray packaging
Verpackungseinheit 154 Stück - packaging unit 154

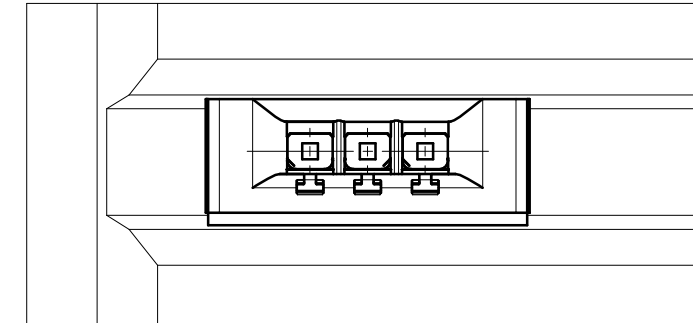

Einzelheit X
detail X

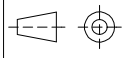

Copyright by ERNI GmbH
Proprietary notice pursuant to ISO 16016 to be observed.

Information: Codierung rot - coding red		Tolerances		Scale	3:1
All rights reserved. Only for Information. To ensure that this is the latest version of this drawing, please contact one of the ERNI companies before using.		Subject to modification without prior notice. Drawing will not be updated.		Designation F 2.54 SRC-A, 3-polig BA 2	
 www.ERNI.com		104202070001		K	
c	14.05.2014			A3	
Index	Date			Class SRCBUG	