

Schottky Bridge Rectifiers

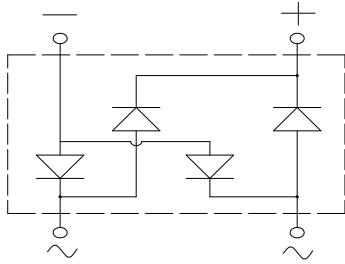
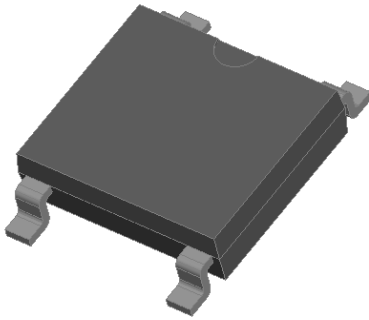

Features

- UL recognition, file #E313149
- Ideal for automated placement
- High surge current capability
- Meets MSL level 1, per J-STD-020, LF maximum peak of 260 °C
- Schottky chip

Typical Applications

General purpose use in high frequency AC/DC bridge full wave rectification for SMPS, lighting ballast, adapter, battery charger, home appliances, office equipment, and telecommunication applications.

Mechanical Data

- **Package:** ABS
Molding compound meets UL 94 V-0 flammability rating, RoHS-compliant, Halogen free
- **Terminals:** Tin plated leads, solderable per J-STD-002 and JESD22-B102
- **Polarity:** As marked on body

■ Maximum Ratings (T_a=25 °C Unless otherwise specified)

PARAMETER	SYMBOL	UNIT	ABSK22S	ABSK24S	ABSK26S	ABSK28S	ABSK210S
Device marking code			ABSK22S	ABSK24S	ABSK26S	ABSK28S	ABSK210S
Repetitive peak reverse voltage	VRRM	V	20	40	60	80	100
Average rectified output current @60Hz sine wave, R-load, T _A (FIG.1)	I _O	A	2.0				
Surge(non-repetitive)forward current @60Hz half sine wave, 1 cycle, T _j =25 °C	IFSM	A	50				
Current squared time @1ms≤t≤8.3ms T _j =25 °C, Rating of per diode	I ² t	A ² s	10				
Storage temperature	T _{stg}	°C	-55 ~+150				
Junction temperature	T _j	°C	-55 ~+125		-55 ~+150		

■ Electrical Characteristics (T_a=25 °C Unless otherwise specified)

PARAMETER	SYMBOL	UNIT	TEST CONDITIONS	ABSK22S	ABSK24S	ABSK26S	ABSK28S	ABSK210S
Maximum instantaneous forward voltage drop per diode	V _F	V	I _F M=1.0A	0.50		0.70	0.85	
Maximum DC reverse current at rated DC blocking voltage per diode	IRRM	uA	T _a =25 °C	500			100	
			T _a =100 °C	10000			5000	

■ Thermal Characteristics (T_a=25°C Unless otherwise specified)

PARAMETER		SYMBOL	UNIT	ABSK22S	ABSK24S	ABSK26S	ABSK28S	ABSK210S
Thermal Resistance	Between junction and ambient, On alumina substrate	R _{θJA}	°C/W	62.5				
	Between junction and lead	R _{θJL}		25.0				

■ Ordering Information (Example)

PREFERRED P/N	PACKING CODE	UNIT WEIGHT(g)	MINIMUM PACKAGE(pcs)	INNER BOX QUANTITY(pcs)	OUTER CARTON QUANTITY(pcs)	DELIVERY MODE
ABSK22S-ABSK210S	F1	Approximate 0.095	4000	8000	64000	13" reel

■ Characteristics (Typical)

FIG1: I_o-T_a Curve

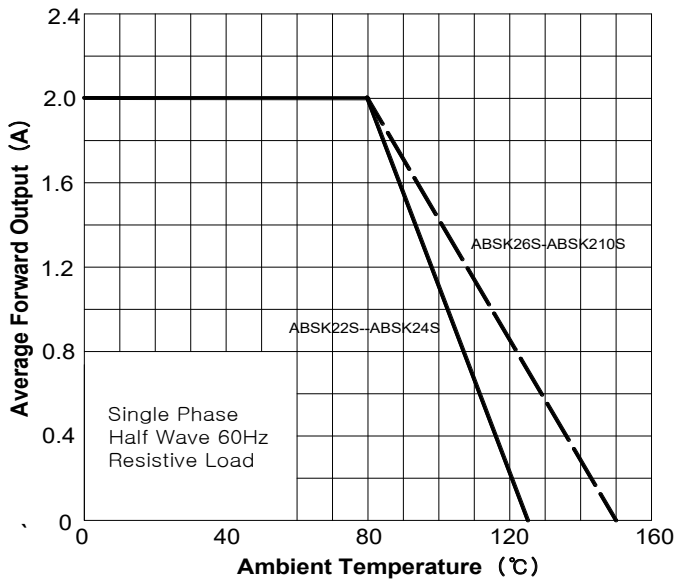

FIG2: Surge Forward Current Capability

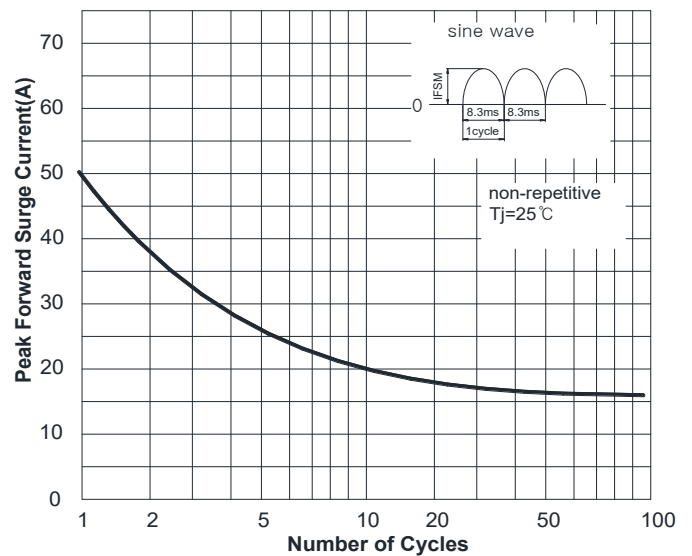

FIG3: Forward Voltage

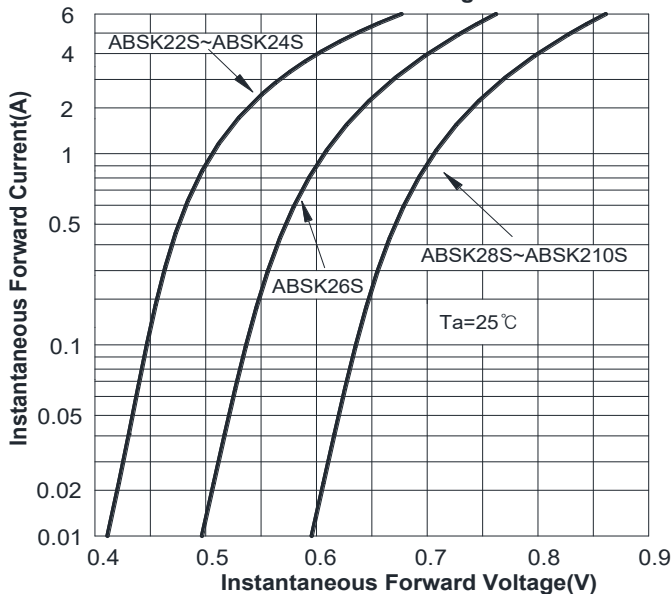
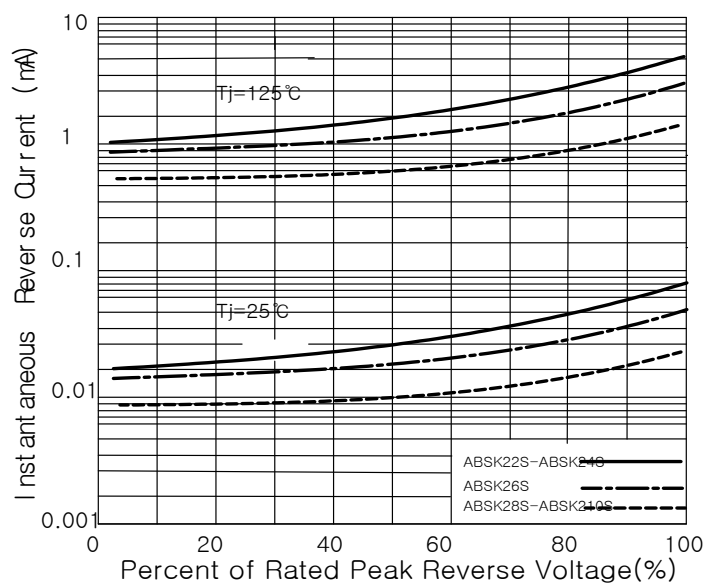
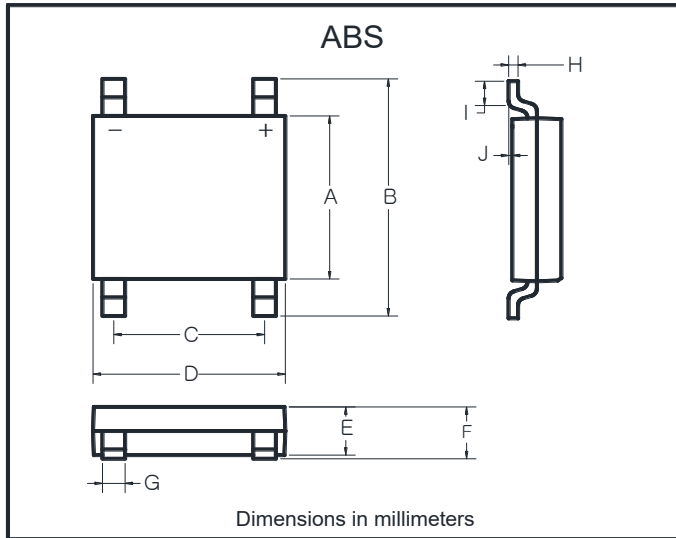

FIG4: Typical Reverse Characteristics



■ **Outline Dimensions**



ABS		
Dim	Min	Max
A	4.30	4.50
B	6.00	6.40
C	3.90	4.10
D	4.90	5.10
E	1.25	1.45
F	1.60 Max	
G	0.60	0.70
H	0.15	0.25
I	0.30	0.80
J	0.02	0.15

■ **Suggested pad layout**

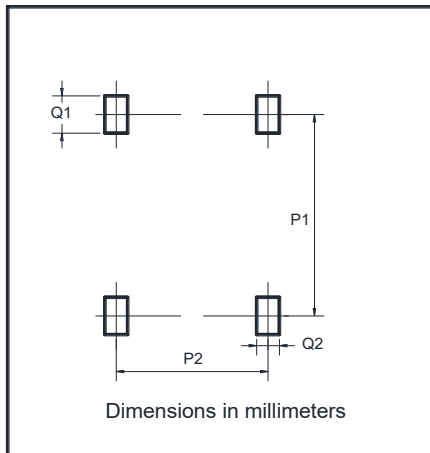

Dim	Min
P1	5.72
P2	4.00
Q1	1.00
Q2	0.90