



2SC5227A

RF Transistor 10V, 70mA, $f_T=7\text{GHz}$, NPN Single CP

ON Semiconductor®

<http://onsemi.com>

Features

- Low-noise : $NF=1.0\text{dB}$ typ ($f=1\text{GHz}$)
- High gain : $|S_{21e}|^2=12\text{dB}$ typ ($f=1\text{GHz}$)
- High cut-off frequency : $f_T=7\text{GHz}$ typ

Specifications

Absolute Maximum Ratings at $T_a=25^\circ\text{C}$

Parameter	Symbol	Conditions	Ratings	Unit
Collector-to-Base Voltage	V_{CBO}		20	V
Collector-to-Emitter Voltage	V_{CEO}		10	V
Emitter-to-Base Voltage	V_{EBO}		2	V
Collector Current	I_C		70	mA
Collector Dissipation	P_C		200	mW
Junction Temperature	T_j		150	$^\circ\text{C}$
Storage Temperature	T_{stg}		-55 to +150	$^\circ\text{C}$

Stresses exceeding Maximum Ratings may damage the device. Maximum Ratings are stress ratings only. Functional operation above the Recommended Operating Conditions is not implied. Extended exposure to stresses above the Recommended Operating Conditions may affect device reliability.

Package Dimensions

unit : mm (typ)

7013A-009

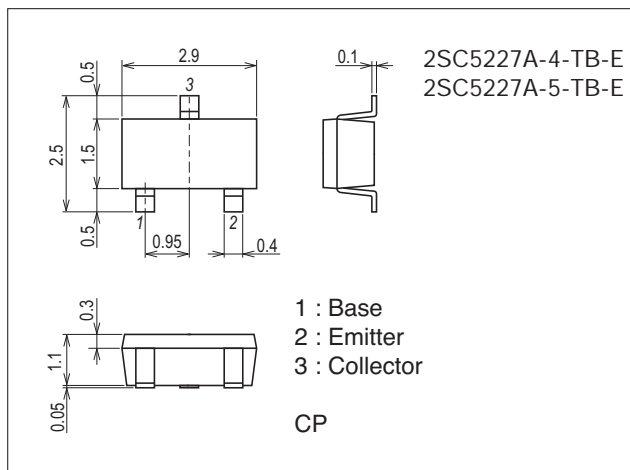

Product & Package Information

- Package : CP
- JEITA, JEDEC : SC-59, TO-236, SOT-23, TO-236AB
- Minimum Packing Quantity : 3,000 pcs./reel

Packing Type: TB

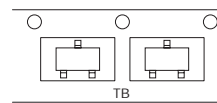

Marking

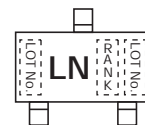

Electrical Connection

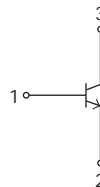

2SC5227A

Electrical Characteristics at Ta=25°C

Parameter	Symbol	Conditions	Ratings			Unit
			min	typ	max	
Collector Cutoff Current	I_{CBO}	$V_{CB}=10V, I_E=0A$			1.0	μA
Emitter Cutoff Current	I_{EBO}	$V_{EB}=1V, I_C=0A$			10	μA
DC Current Gain	h_{FE}	$V_{CE}=5V, I_C=20mA$	60*		270*	
Gain-Bandwidth Product	f_T	$V_{CE}=5V, I_C=20mA$	5	7		GHz
Output Capacitance	C_{ob}	$V_{CB}=10V, f=1MHz$		0.75	1.2	pF
Reverse Transfer Capacitance	C_{re}	$V_{CB}=10V, f=1MHz$		0.5		pF
Forward Transfer Gain	$ S_{21e} ^2_1$	$V_{CE}=5V, I_C=20mA, f=1GHz$	9	12		dB
	$ S_{21e} ^2_2$	$V_{CE}=2V, I_C=3mA, f=1GHz$		8		dB
Noise Figure	NF	$V_{CE}=5V, I_C=7mA, f=1GHz$		1.0	1.8	dB

* : The 2SC5227A is classified by 20mA h_{FE} as follows :

Rank	3	4	5
h_{FE}	60 to 120	90 to 180	135 to 270

Ordering Information

Device	Package	Shipping	memo
2SC5227A-4-TB-E	CP	3,000pcs./reel	Pb Free
2SC5227A-5-TB-E	CP	3,000pcs./reel	

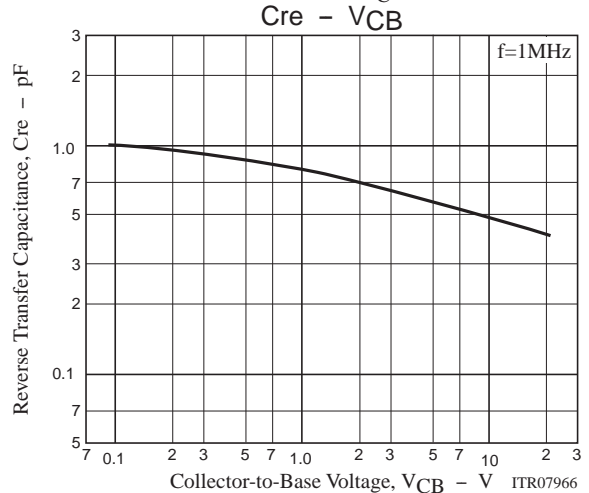
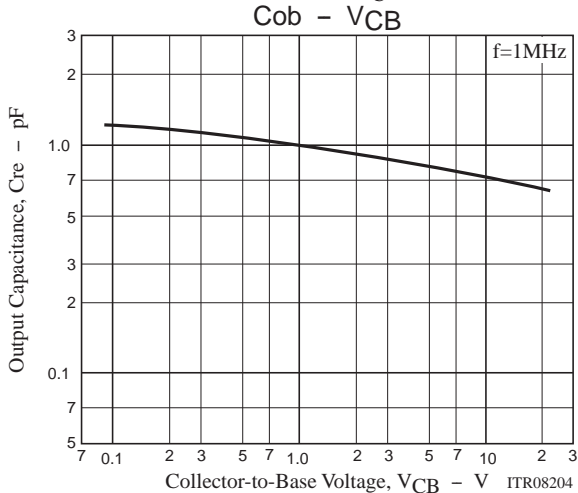
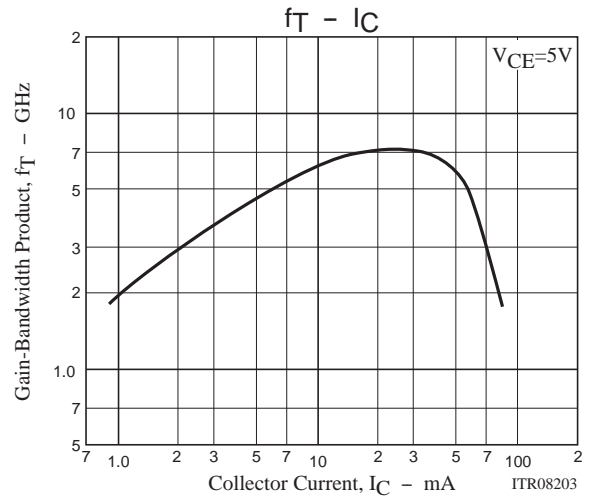
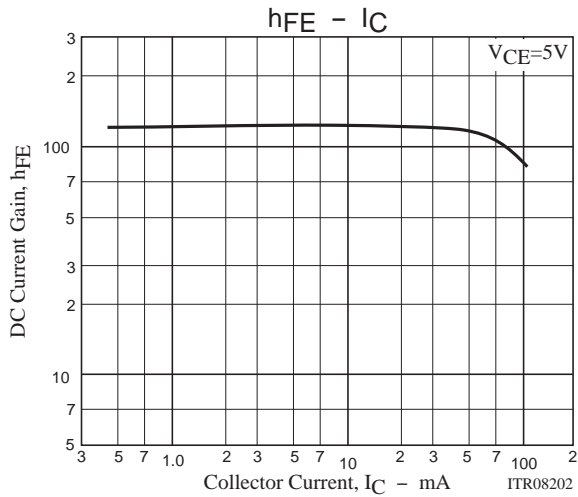

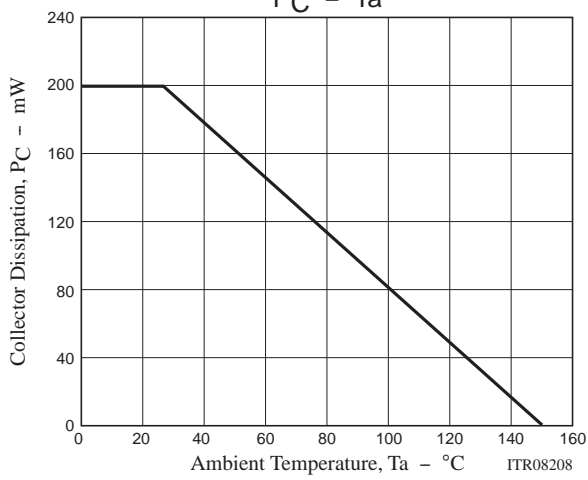
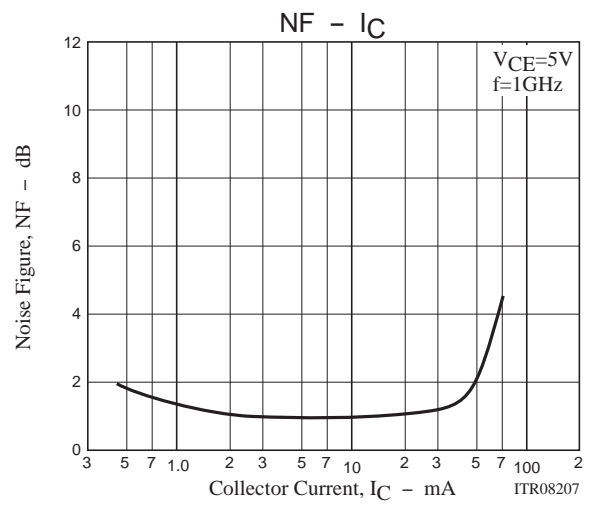
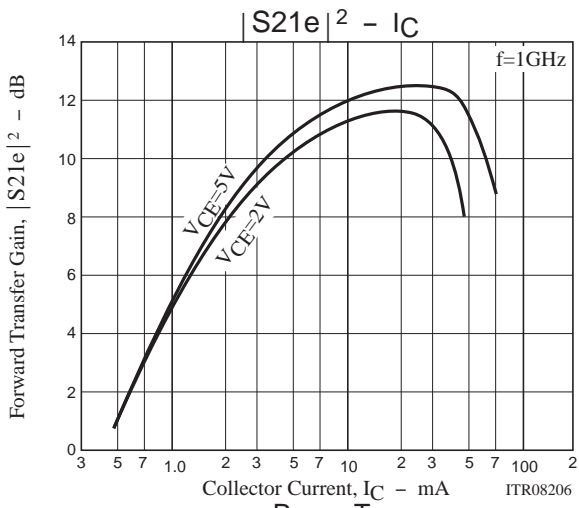

2SC5227A

f=100MHz, 200MHz to 2000MHz(200MHz Step)

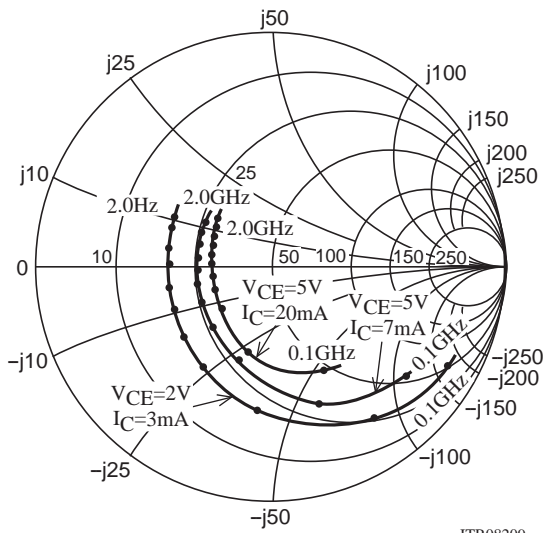

f=100MHz, 200MHz to 2000MHz(200MHz Step)

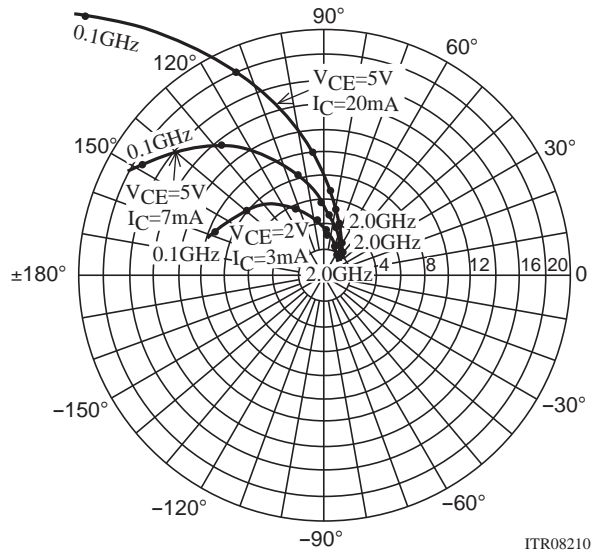

f=100MHz, 200MHz to 2000MHz(200MHz Step)

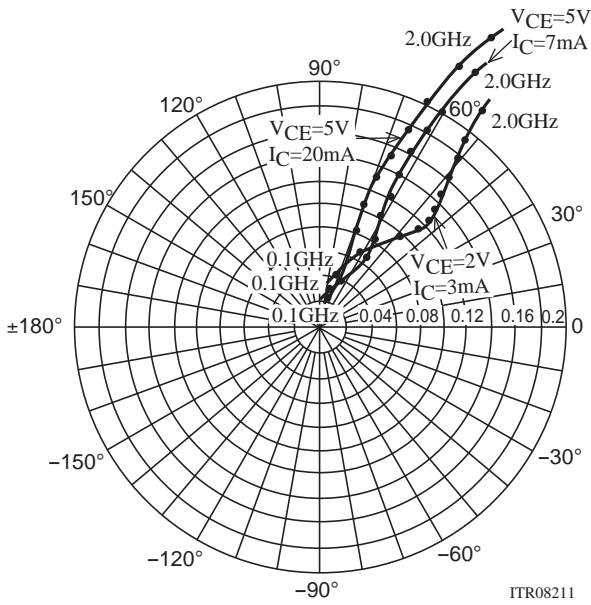

f=100MHz, 200MHz to 2000MHz(200MHz Step)

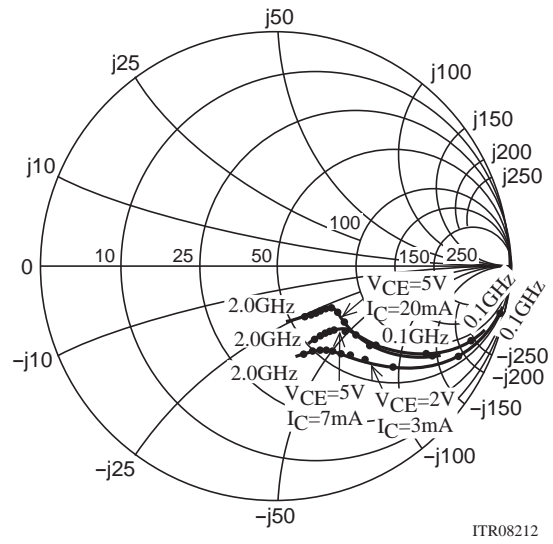

2SC5227A

S Parameters (Common emitter)

$V_{CE}=5V, I_C=7mA, Z_O=50\Omega$

Freq(MHz)	S11	$\angle S11$	S21	$\angle S21$	S12	$\angle S12$	S22	$\angle S22$
100	0.722	-41.6	17.352	148.7	0.029	70.9	0.883	-21.3
200	0.587	-73.2	13.419	127.6	0.046	60.8	0.710	-33.1
400	0.426	-113.0	8.371	105.1	0.067	56.9	0.507	-40.7
600	0.369	-136.6	5.914	92.7	0.084	58.4	0.423	-42.5
800	0.344	-152.9	4.593	83.9	0.102	60.3	0.382	-43.9
1000	0.334	-165.7	3.750	76.7	0.121	61.5	0.360	-46.3
1200	0.326	-177.9	3.178	70.3	0.141	62.0	0.350	-49.1
1400	0.324	172.3	2.784	64.9	0.162	61.8	0.341	-52.2
1600	0.328	163.4	2.476	59.5	0.183	61.2	0.334	-56.4
1800	0.335	154.5	2.246	54.6	0.204	60.5	0.328	-60.8
2000	0.346	147.5	3.073	50.0	0.226	59.6	0.328	-65.4

$V_{CE}=5V, I_C=20mA, Z_O=50\Omega$

Freq(MHz)	S11	$\angle S11$	S21	$\angle S21$	S12	$\angle S12$	S22	$\angle S22$
100	0.477	-66.8	28.090	133.6	0.022	67.7	0.726	-32.7
200	0.358	-104.1	17.995	112.9	0.035	65.3	0.506	-41.6
400	0.288	-142.2	9.903	95.9	0.057	68.3	0.350	-42.4
600	0.273	-159.8	6.777	86.7	0.081	69.9	0.299	-41.8
800	0.270	-171.7	5.181	79.9	0.104	70.2	0.278	-43.2
1000	0.271	178.7	4.209	73.9	0.129	69.1	0.269	-45.9
1200	0.273	169.4	3.554	68.5	0.153	67.9	0.264	-49.6
1400	0.275	161.1	3.085	63.6	0.177	66.2	0.258	-53.3
1600	0.284	153.4	2.749	59.1	0.202	64.3	0.253	-58.3
1800	0.294	145.6	2.479	54.6	0.224	62.5	0.249	-63.4
2000	0.302	140.8	2.295	50.6	0.248	60.4	0.248	-68.7

$V_{CE}=2V, I_C=3mA, Z_O=50\Omega$

Freq(MHz)	S11	$\angle S11$	S21	$\angle S21$	S12	$\angle S12$	S22	$\angle S22$
100	0.858	-30.5	9.283	157.3	0.039	73.6	0.944	-15.6
200	0.769	-57.4	8.036	138.7	0.068	61.4	0.834	-27.5
400	0.607	-97.1	5.756	113.9	0.099	48.4	0.641	-40.5
600	0.528	-123.2	4.302	98.1	0.114	44.4	0.525	-46.5
800	0.486	-141.6	3.414	87.0	0.125	43.9	0.465	-50.2
1000	0.460	-156.4	2.834	78.0	0.137	45.4	0.429	-53.7
1200	0.453	-169.4	2.429	70.3	0.149	47.5	0.408	-57.3
1400	0.440	179.8	2.143	63.6	0.163	49.2	0.395	-60.9
1600	0.441	170.1	1.919	57.4	0.179	50.8	0.385	-65.4
1800	0.447	160.4	1.739	51.7	0.196	52.3	0.381	-70.1
2000	0.454	152.5	1.621	46.4	0.215	53.3	0.379	-75.2

Embossed Taping Specification

2SC5227A-4-TB-E, 2SC5227A-5-TB-E

1. Packing Format

Package Name	Carrier Tape Type	Maximum Number of devices contained (pcs)			Packing format	
		Reel	Inner box	Outer box	Inner BOX (C-1)	Outer BOX (A-7)
CP	CP	3,000	15,000	90,000	5 reels contained Dimensions:mm (external) 183×72×185	6 inner boxes contained Dimensions:mm (external) 440×195×210

Packing method

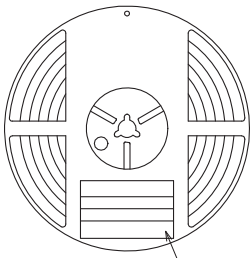

Reel label

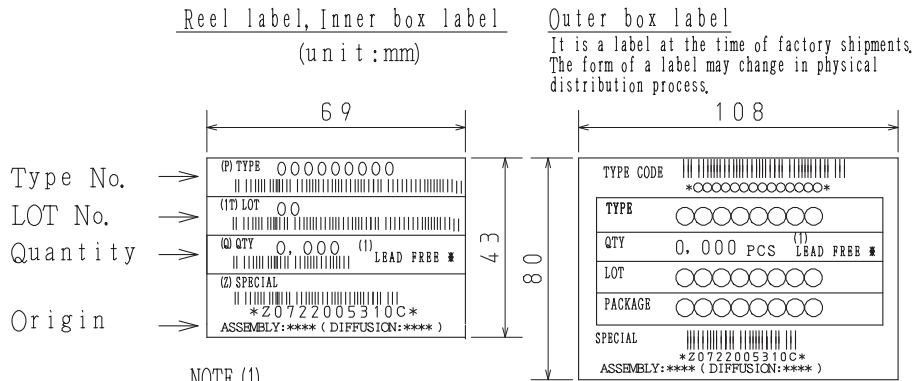

NOTE (1)

The LEAD FREE * description shows that the surface treatment of the terminal is lead free.

Label	JEITA Phase
LEAD FREE 3	JEITA Phase 3A
LEAD FREE 4	JEITA Phase 3

2. Taping configuration

2-1. Carrier tape size (unit:mm)

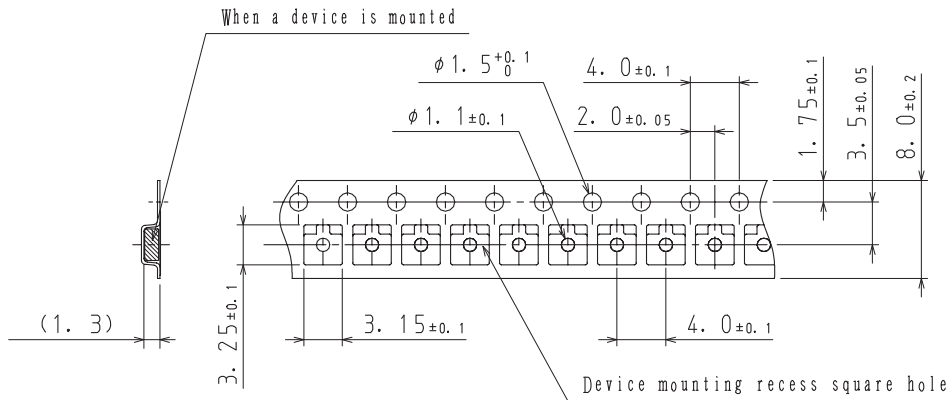

2-2. Device placement direction

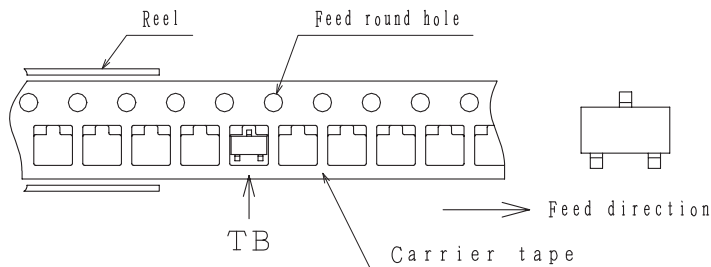

Those with one electrode terminal on the feed hole side.....TB

2SC5227A

Outline Drawing

2SC5227A-4-TB-E, 2SC5227A-5-TB-E

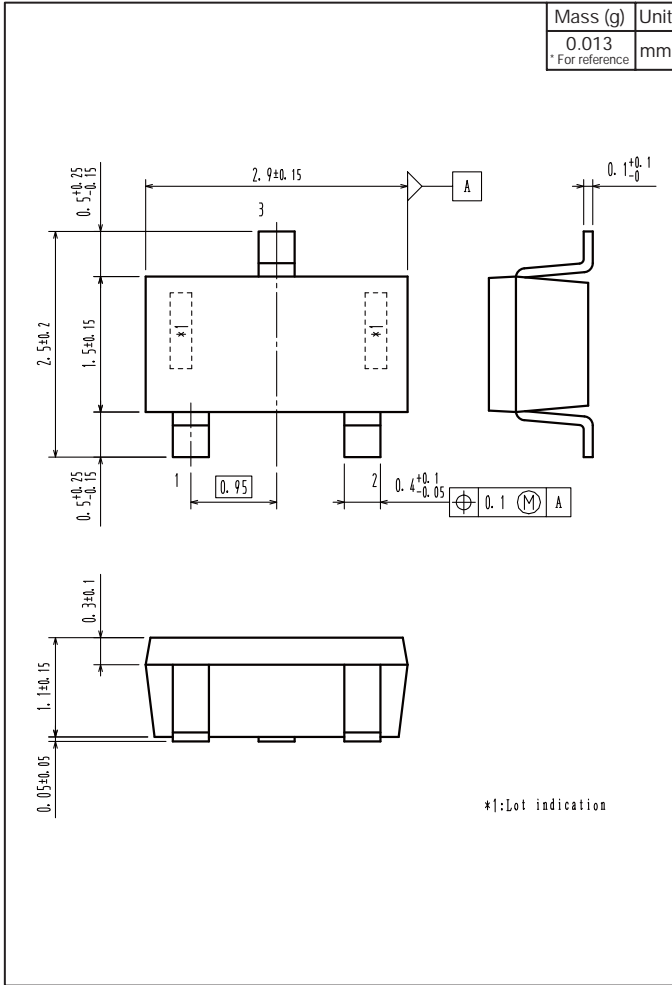

Land Pattern Example

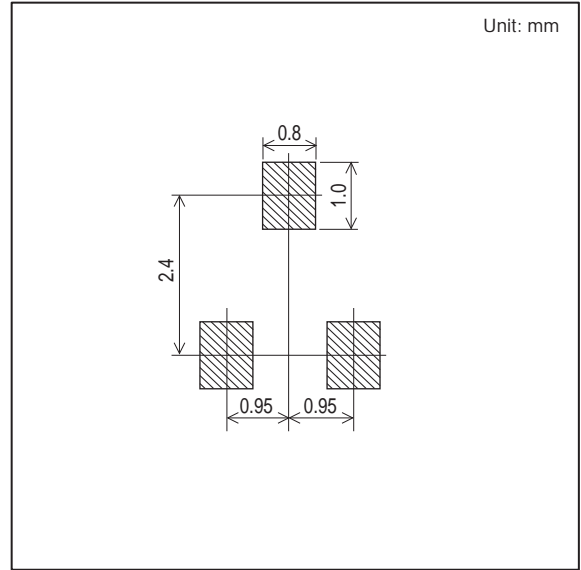

ON Semiconductor and the ON logo are registered trademarks of Semiconductor Components Industries, LLC (SCILLC). SCILLC owns the rights to a number of patents, trademarks, copyrights, trade secrets, and other intellectual property. A listing of SCILLC's product/patent coverage may be accessed at www.onsemi.com/site/pdf/Patent-Marking.pdf. SCILLC reserves the right to make changes without further notice to any products herein. SCILLC makes no warranty, representation or guarantee regarding the suitability of its products for any particular purpose, nor does SCILLC assume any liability arising out of the application or use of any product or circuit, and specifically disclaims any and all liability, including without limitation special, consequential or incidental damages. "Typical" parameters which may be provided in SCILLC data sheets and/or specifications can and do vary in different applications and actual performance may vary over time. All operating parameters, including "Typicals" must be validated for each customer application by customer's technical experts. SCILLC does not convey any license under its patent rights nor the rights of others. SCILLC products are not designed, intended, or authorized for use as components in systems intended for surgical implant into the body, or other applications intended to support or sustain life, or for any other application in which the failure of the SCILLC product could create a situation where personal injury or death may occur. Should Buyer purchase or use SCILLC products for any such unintended or unauthorized application, Buyer shall indemnify and hold SCILLC and its officers, employees, subsidiaries, affiliates, and distributors harmless against all claims, costs, damages, and expenses, and reasonable attorney fees arising out of, directly or indirectly, any claim of personal injury or death associated with such unintended or unauthorized use, even if such claim alleges that SCILLC was negligent regarding the design or manufacture of the part. SCILLC is an Equal Opportunity/Affirmative Action Employer. This literature is subject to all applicable copyright laws and is not for resale in any manner.