

RECOMMENDED SOLDER PAD LAYOUT

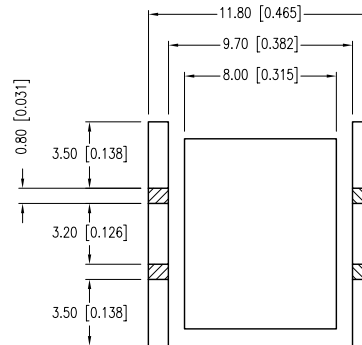

ELECTRO-OPTICAL CHARACTERISTICS $T_A=25^\circ\text{C}$ $I_f=1000\text{mA}$						
PARAMETER	SYMBOL	MIN	TYP	MAX	UNITS	TEST COND
FORWARD VOLTAGE	$V_f$	9.3	10.4	11.5	V	$I_f=1000\text{mA}$
REVERSE VOLTAGE	$V_r$			15	V	$I_r=30\mu\text{A}$
LUMINOUS FLUX	$I_v$	560	660		lm	$I_f=1000\text{mA}$
COLOR TEMPERATURE		3710	4000	4260	$^\circ\text{K}$	
VIEWING ANGLE			120		2x theta	
CRI			83			
EMITTED COLOR:	NEUTRAL WHITE					
EPOXY LENS FINISH:	WATER CLEAR LENS					

LIMITS OF SAFE OPERATION AT 25°C		
PARAMETER	MAX	UNITS
DC FORWARD CURRENT*	1000	mA
PEAK FORWARD CURRENT**	1200	mA
POWER DISSIPATION	11.5	W
OPERATING TEMP.	-40 TO +100	$^\circ\text{C}$
STORAGE TEMP.	-40 TO +110	$^\circ\text{C}$

\*MOUNTING ON METAL CORE PCB  
 \*\*0.1ms PULSE WIDTH, 1/10 DUTY CYCLE

THERMAL PARAMETERS		
PARAMETER	MAX	UNITS
JUNCTION TEMPERATURE	110	$^\circ\text{C}$
THERMAL RESISTANCE (JUNCTION/SOLDER)	2.7	$^\circ\text{C}/\text{W}$
THERMAL RESISTANCE (JUNCTION/AMBIENT)	13.5	$^\circ\text{C}/\text{W}$
TEMPERATURE COEFFICIENT OF $V_f$	-5.6	mV/ $^\circ\text{C}$

CAUTION: MOISTURE SENSITIVE DEVICE  
 PER JEDEC LEVEL 2a STANDARDS

CAUTION: STATIC SENSITIVE DEVICE  
 FOLLOW PROPER E.S.D. HANDLING PROCEDURES  
 WHEN WORKING WITH THIS PART.

\*UNLESS OTHERWISE SPECIFIED TOLERANCES PER DECIMAL PRECISION ARE: X=±1 (±0.039), X.X=±0.5 (±0.020), X.XX=±0.25 (±0.010), X.XXX=±0.127 (±0.005). LEAD SIZE=±0.05 (±0.002), LEAD LENGTH=±0.75 (±0.030). MIN=  $^{+0.00}_{-0.00}$  DECIMAL PRECISION MAX.=  $^{+0.00}_{-0.00}$  DECIMAL PRECISION

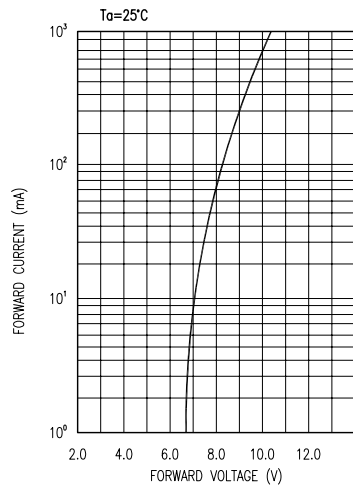

FORWARD CURRENT VS FORWARD VOLTAGE

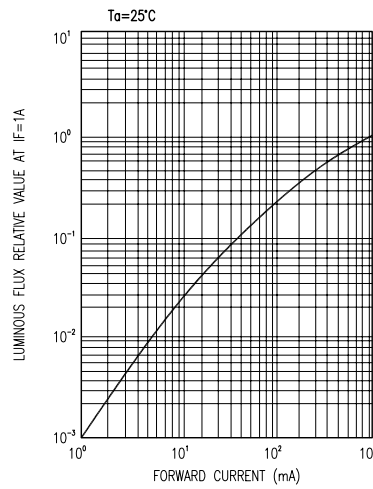

LUMINOUS FLUX VS FORWARD CURRENT

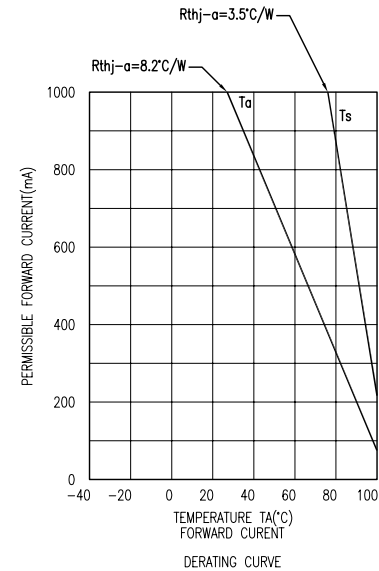

DERATING CURVE

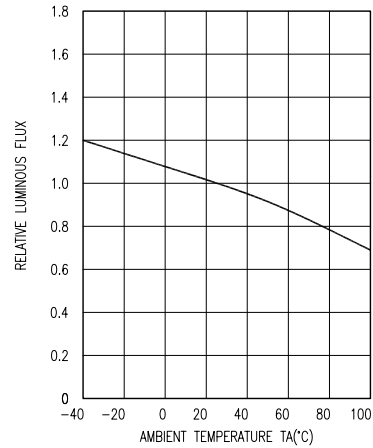

LUMINOUS FLUX VS AMBIENT TEMPERATURE

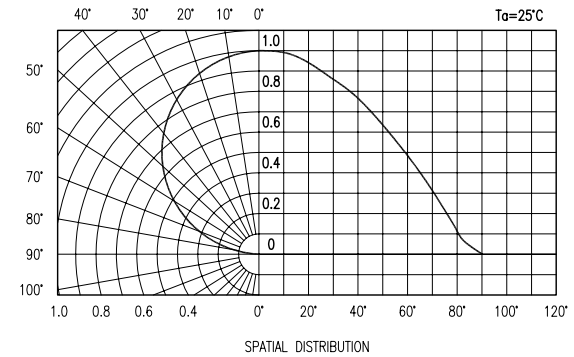

SPATIAL DISTRIBUTION

\*UNLESS OTHERWISE SPECIFIED TOLERANCES PER DECIMAL PRECISION ARE: X=±1 (±0.039), X.X=±0.5 (±0.020), X.XX=±0.25 (±0.010), X.XXX=±0.127 (±0.005). LEAD SIZE=±0.05 (±0.002), LEAD LENGTH=±0.75 (±0.030). MIN.= +DECIMAL PRECISION MAX.= +0.00 -DECIMAL PRECISION



290 E. HELEN ROAD  
PALATINE, IL 60067-6976  
PHONE: +1.847.359.2790  
FAX: +1.847.359.6538  
WEB: WWW.LUMEX.COM

12mm x 12mm SURFACE MOUNT LED, NEUTRAL WHITE.

\*\*THE SPECIFICATIONS MAY CHANGE AT ANY TIME WITHOUT NOTICE DUE TO NEW MATERIALS OR PRODUCT IMPROVEMENT.\*\*

CONFIDENTIAL INFORMATION  
THE INFORMATION CONTAINED IN THIS DOCUMENT IS THE PROPERTY OF LUMEX INC. EXCEPT AS SPECIFICALLY AUTHORIZED IN WRITING BY LUMEX INC., THE HOLDER OF THIS DOCUMENT SHALL KEEP ALL INFORMATION CONTAINED HEREIN CONFIDENTIAL AND SHALL PROTECT SAME IN WHOLE OR IN PART FROM DISCLOSURE AND DISSEMINATION TO ALL THIRD PARTIES.

DATE:	09.22.11	DRAWN BY:	AB
PAGE:	2 OF 4	CHKD BY:	KF
SCALE:	NTS	APRVD BY:	JD
UNIT:	mm [INCH]		



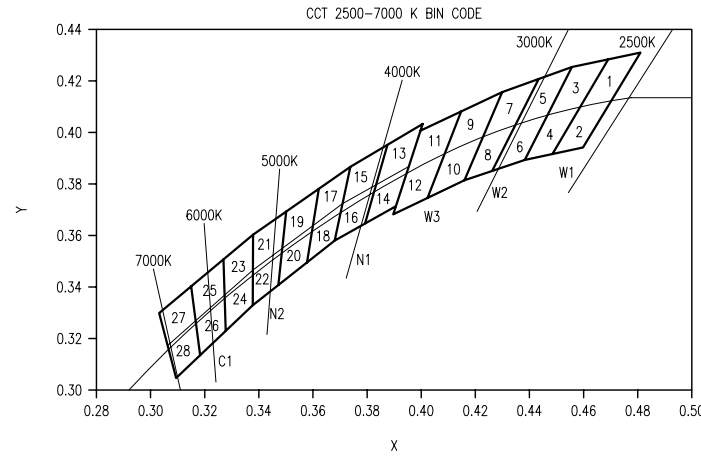

COLOR	GROUP	CHROMATICITY REGIONS	MIN.	TYP.	MAX.
WARM WHITE	W1	1,2,3,4	2580	2700	2870
	W2	5,6,7,8	2870	3000	3220
	W3	9,10,11,12	3220	3500	3710
WARM WHITE	N1	13,14,15,16	3710	4000	4260
	N2	17,18,19,20,21,22	4260	4700	5310
COOL WHITE	C1	23,24,25,26,27,28	5310	6000	7040

	X	Y	X	Y	X	Y	X	Y	X	Y	X	Y				
1	0.4582	0.4099	6	0.4259	0.3853	11	0.3941	0.3848	16	0.3670	0.3578	21	0.3496	0.3702		
	0.4687	0.4289		0.4342	0.4028		0.3996	0.4015		0.3702	0.3722		0.3376	0.3616	0.3160	0.3274
	0.4813	0.4319		0.4465	0.4071		0.4146	0.4089		0.3825	0.3798		0.3370	0.3472	0.3175	0.3139
2	0.4700	0.4126	7	0.4373	0.3893	12	0.4080	0.3916	17	0.3783	0.3646	22	0.3481	0.3557		
	0.4483	0.3919		0.4221	0.3984		0.3889	0.3690		0.3736	0.3874		0.3481	0.3557	0.3144	0.3408
	0.4582	0.4099		0.4299	0.4165		0.3941	0.3848		0.3616	0.3788		0.3370	0.3472	0.3028	0.3304
3	0.4700	0.4126	8	0.4430	0.4212	13	0.4080	0.3916	18	0.3592	0.3641	23	0.3364	0.3328		
	0.4593	0.3944		0.4342	0.4028		0.4017	0.3751		0.3703	0.3726		0.3466	0.3411	0.3160	0.3274
	0.4465	0.4071		0.4147	0.3814		0.3825	0.3798		0.3703	0.3726		0.3376	0.3616	0.3160	0.3274
4	0.4562	0.4260	9	0.4687	0.4289	14	0.4006	0.4044	19	0.3592	0.3641	24	0.3260	0.3512		
	0.4582	0.4099		0.4221	0.3984		0.3869	0.3959		0.3568	0.3495		0.3265	0.3371	0.3081	0.3049
	0.4483	0.3919		0.4259	0.3853		0.3950	0.3875		0.3670	0.3578		0.3370	0.3472	0.3175	0.3139
5	0.4582	0.4099	10	0.4080	0.3916	15	0.3702	0.3722	20	0.3592	0.3641	25	0.3260	0.3512		
	0.4562	0.4260		0.4017	0.3751		0.3702	0.3722		0.3592	0.3641		0.3260	0.3512	0.3144	0.3408
	0.4465	0.4071		0.4221	0.3984		0.3869	0.3958		0.3736	0.3874		0.3481	0.3557	0.3160	0.3274
	0.4465	0.4071		0.4147	0.3814		0.3825	0.3798		0.3568	0.3495		0.3265	0.3371		

\*UNLESS OTHERWISE SPECIFIED TOLERANCES PER DECIMAL PRECISION ARE: X=±1 (±0.039), X.X=±0.5 (±0.020), X.XX=±0.25 (±0.010), X.XXX=±0.127 (±0.005). LEAD SIZE=±0.05 (±0.002), LEAD LENGTH=±0.75 (±0.030). MIN.= +DECIMAL PRECISION MAX.= +0.00 -DECIMAL PRECISION

**LUMEX**  
 Creating LED and LCD Solutions Together™

290 E. HELEN ROAD  
 PALATINE, IL 60067-6976  
 PHONE: +1.847.359.2790  
 FAX: +1.847.359.6538  
 WEB: WWW.LUMEX.COM

12mm x 12mm SURFACE MOUNT LED, NEUTRAL WHITE.

\*\*THE SPECIFICATIONS MAY CHANGE AT ANY TIME WITHOUT NOTICE DUE TO NEW MATERIALS OR PRODUCT IMPROVEMENT.\*\*

CONFIDENTIAL INFORMATION  
 THE INFORMATION CONTAINED IN THIS DOCUMENT IS THE PROPERTY OF LUMEX INC. EXCEPT AS SPECIFICALLY AUTHORIZED IN WRITING BY LUMEX INC., THE HOLDER OF THIS DOCUMENT SHALL KEEP ALL INFORMATION CONTAINED HEREIN CONFIDENTIAL AND SHALL PROTECT SAME IN WHOLE OR IN PART FROM DISCLOSURE AND DISSEMINATION TO ALL THIRD PARTIES.

DATE:	09.22.11	DRAWN BY:	AB
PAGE:	3 OF 4	CHKD BY:	KF
SCALE:	NTS	APRVD BY:	JD
UNIT:	mm [INCH]		Ⓟ

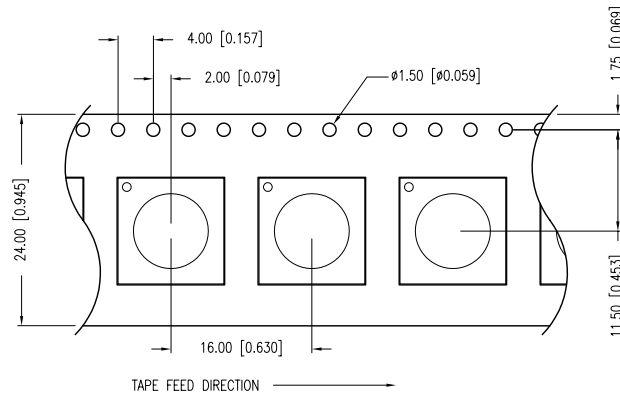
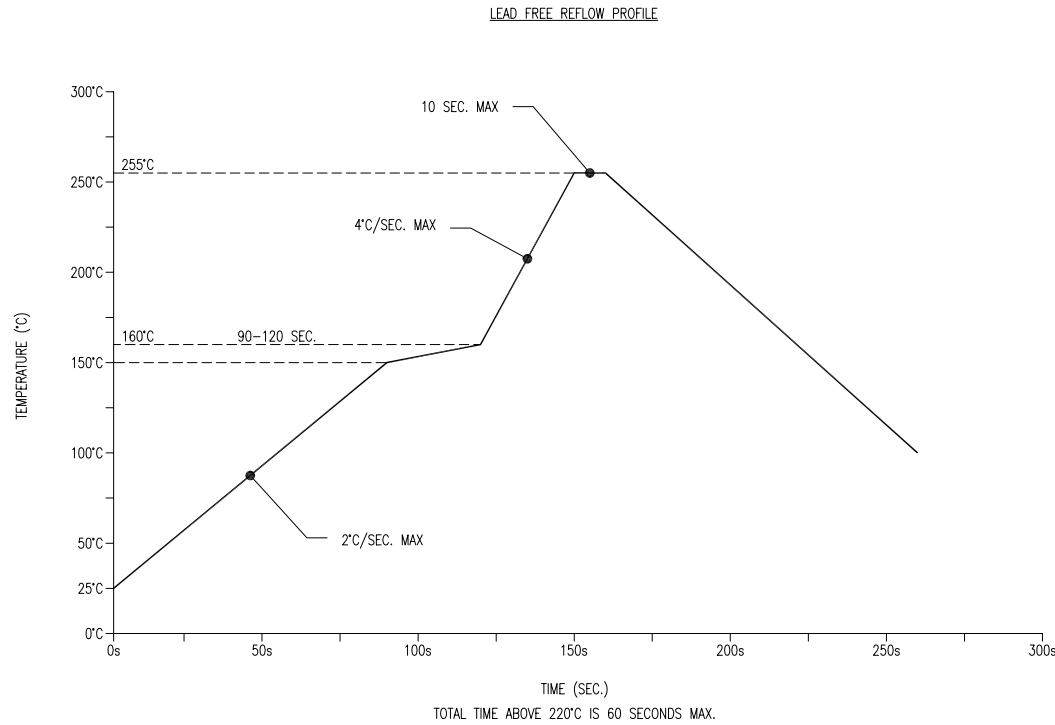

\*UNLESS OTHERWISE SPECIFIED TOLERANCES PER DECIMAL PRECISION ARE: X=±1 (±0.039), X,X=±0.5 (±0.020), X,XX=±0.25 (±0.010), X,XXX=±0.127 (±0.005). LEAD SIZE=±0.05 (±0.002), LEAD LENGTH=±0.75 (±0.030). MIN= <sup>+DECIMAL PRECISION</sup> <sub>-0.00</sub> MAX.= <sup>+0.00</sup> <sub>-DECIMAL PRECISION</sub>

UNCONTROLLED DOCUMENT



290 E. HELEN ROAD  
PALATINE, IL 60067-6976  
PHONE: +1.847.359.2790  
FAX: +1.847.359.6538  
WEB: WWW.LUMEX.COM

12mm x 12mm SURFACE MOUNT LED, NEUTRAL WHITE.

\*\*THE SPECIFICATIONS MAY CHANGE AT ANY TIME WITHOUT NOTICE DUE TO NEW MATERIALS OR PRODUCT IMPROVEMENT.\*\*

CONFIDENTIAL INFORMATION  
THE INFORMATION CONTAINED IN THIS DOCUMENT IS THE PROPERTY OF LUMEX INC. EXCEPT AS SPECIFICALLY AUTHORIZED IN WRITING BY LUMEX INC., THE HOLDER OF THIS DOCUMENT SHALL KEEP ALL INFORMATION CONTAINED HEREIN CONFIDENTIAL AND SHALL PROTECT SAME IN WHOLE OR IN PART FROM DISCLOSURE AND DISSEMINATION TO ALL THIRD PARTIES.

DATE:	09.22.11	DRAWN BY:	AB
PAGE:	4 OF 4	CHKD BY:	KF
SCALE:	NTS	APRVD BY:	JD
UNIT:	mm [INCH]		Ⓟ