



Continental Device India Limited

An ISO/TS 16949, ISO 9001 and ISO 14001 Certified Company



ISO 14001



ITO-220AC (2 Leads) Isolated Leaded Plastic Package

Package Outline, Packing Tube, Packaging and Handling Information

ITO-220AC Isolated Leaded Plastic Package

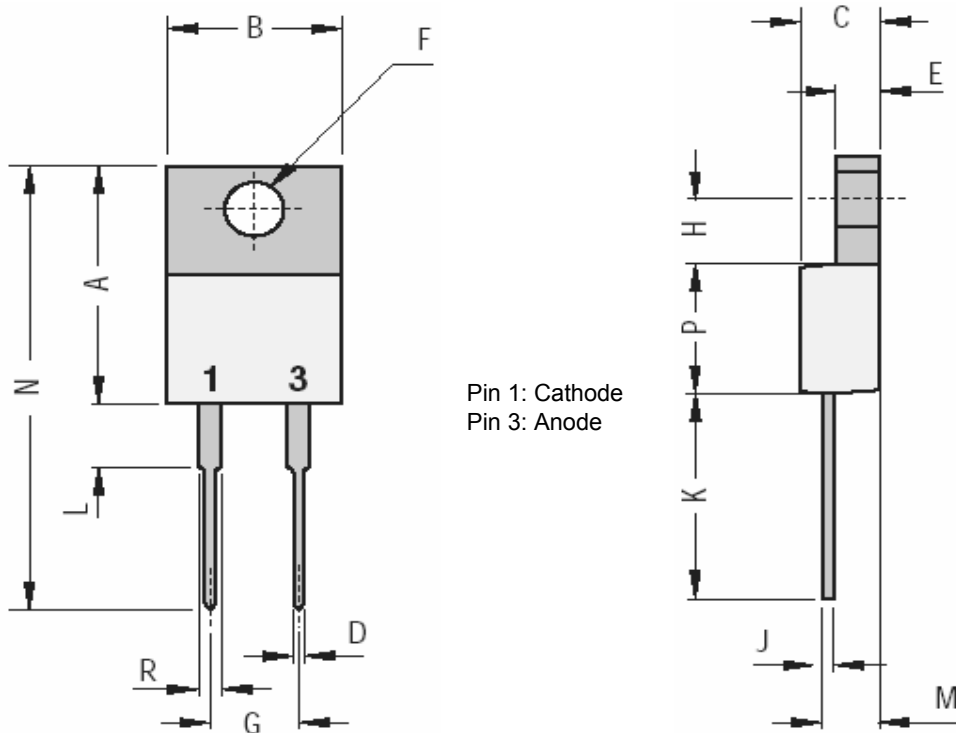

| DIM | Min | Max |
|-----|-------|-------|
| A | 14.90 | 15.50 |
| B | 9.85 | 10.35 |
| C | 4.25 | 4.75 |
| D | 0.470 | 0.730 |
| E | 2.81 | 3.31 |
| F | 3.25 | 3.55 |
| G | 4.88 | 5.14 |
| H | 4.18 | 4.42 |

| DIM | Min | Max |
|-----|-------|-------|
| J | 0.47 | 0.73 |
| K | 12.60 | 13.20 |
| L | 3.75 | 4.25 |
| M | 2.95 | 3.45 |
| N | 27.50 | 28.70 |
| P | 8.15 | 8.25 |
| R | 1.17 | 1.43 |

All Dimensions are in mm

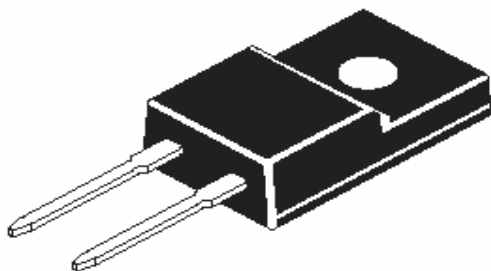

ITO-220AC Packaging Tube

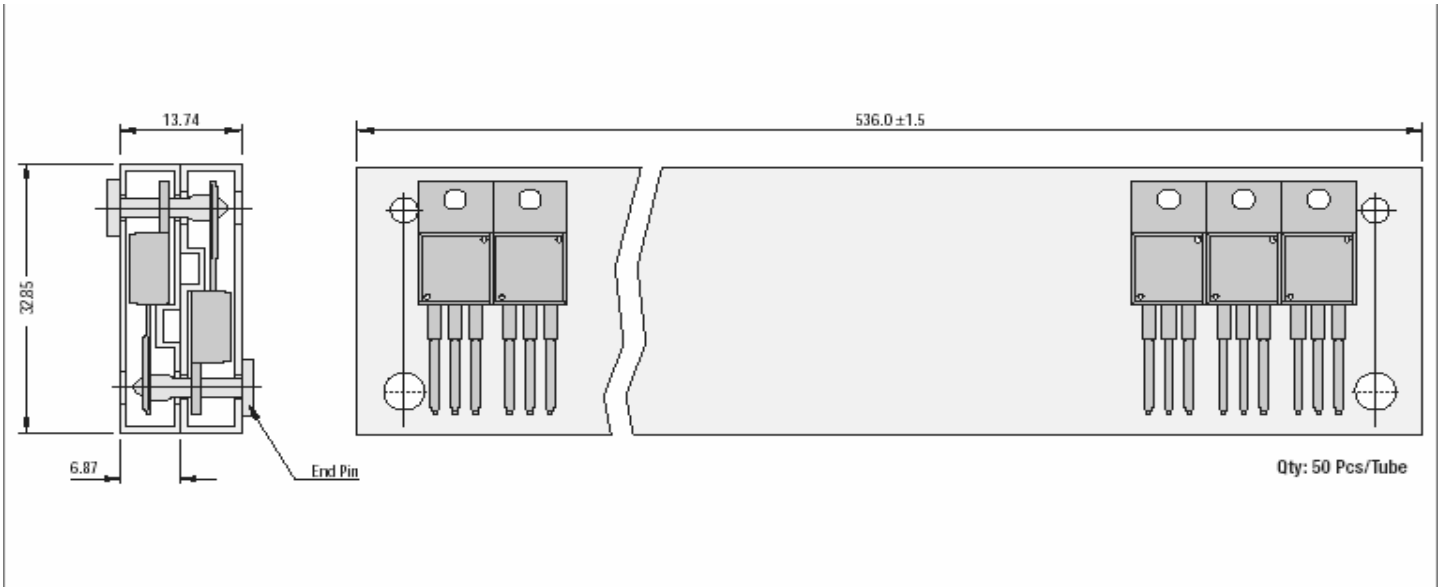

All Dimensions are in mm

Ammo Packaging for Tubes

Ammo Pack for Tubes

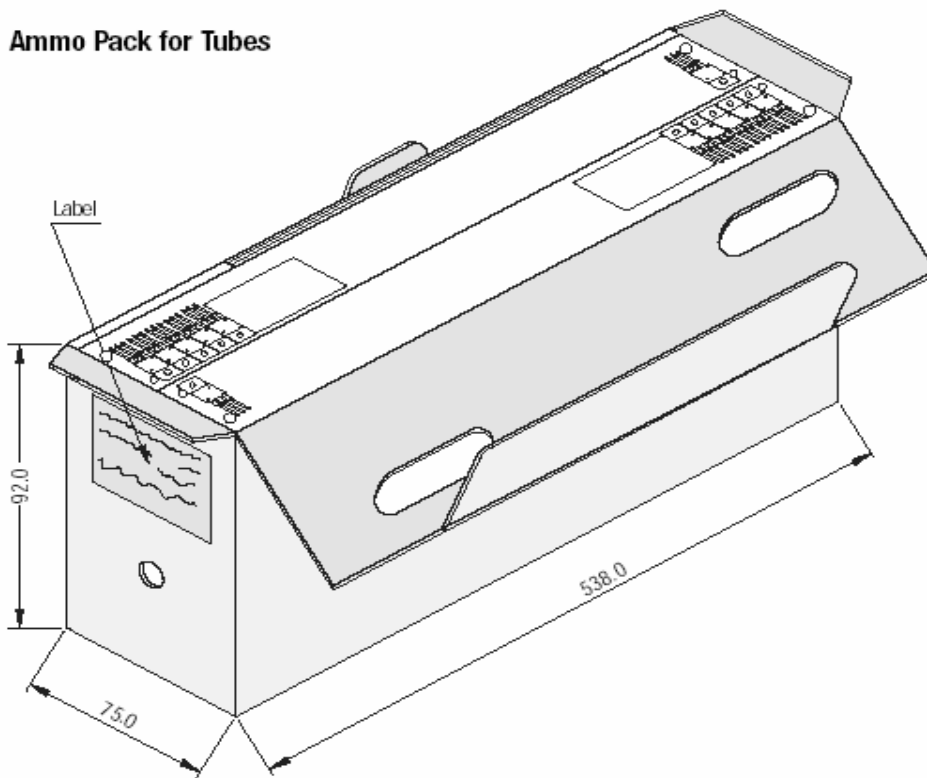

All Dimensions are in mm

Component Disposal Instructions

1. CDIL Semiconductor Devices are RoHS compliant, customers are requested to please dispose as per prevailing Environmental Legislation of their Country.
2. In Europe, please dispose as per EU Directive 2002/96/EC on Waste Electrical and Electronic Equipment (WEEE).

Precautions for physical handling of Power Plastic Transistors (TO-126, TO-220, TO-220FP, TO-3P)

It is a fundamentally accepted fact that a higher junction operating temperature accelerates failure. Circuit designers, must therefore ensure minimum temperature rise keeping in view Safe Operating Area (SOA) characteristics as well as suitable mounting on a properly designed heat sink. When mounting power transistors certain precautions must be taken in operations such as bending of leads, mounting of heat sink, soldering and removal of flux residue. If these operations are not carried out correctly, the device can be damaged or reliability compromised.

1. Bending and cutting leads

The bending or cutting of the leads requires the following precautions:

- 1.1 When bending the leads they must be clamped tightly between the package and the bending point to avoid strain on the package (in particular in the area where the leads enter the resin). This also applies to cutting the leads (Fig. 1).
- 1.2 The leads must be bent at a minimum distance of 3 mm from the package (Fig. 2a).
- 1.3 The leads should not be bent at an angle of more than 90° and they must be bent only once (Fig. 2b).
- 1.4 The leads must never be bent laterally (Fig. 2c).
- 1.5 Check that the tool used to cut or form the leads does not damage them or ruin their surface finish.

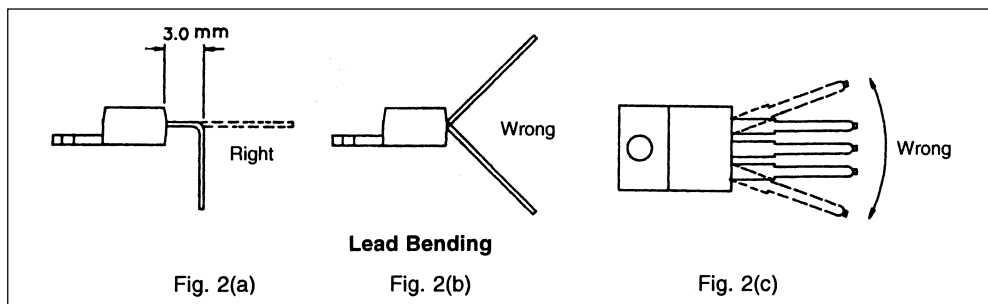
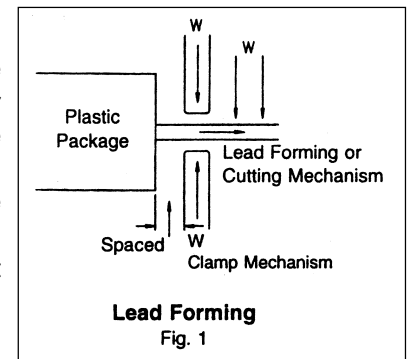

2. Mounting on printed circuit

During mounting operations be careful not to apply stress to the power transistor.

- 2.1 Adhere strictly to the pin spacing of the transistor to avoid forcing the leads.
- 2.2 Leave a suitable space between printed circuit and transistor; if necessary use a spacer.
- 2.3 When fixing the device to the printed circuit do not put mechanical stress on the transistor. For this purpose the device should be soldered to the printed circuit board after the transistor has been fixed to the heat sink and the heat sink to the printed circuit board.

3. Soldering

In general a transistor should never be exposed to high temperature for any length of time. It is therefore preferable to use soldering methods where the transistor is exposed to the lowest possible temperatures for a short time.

- 3.1 Tolerable conditions are 260°C for 10 sec or 350°C for 3 sec. The graphs in fig. 3 give an idea of the excess junction temperature during the soldering process for a TO-220. It is also important to use suitable fixes for the tin baths to avoid deterioration of the leads or of the package resin.
- 3.2 An excess of residual flux between the pins of the transistor or in contact with the resin can reduce the long-term reliability of the device. The solvent for removing excess fluid must be chosen with care. The use of

solvents derived from trichloroethylene is not recommended on plastic packages because the residue can cause corrosion. Recommended solvents are freon or isopropyl alcohol.

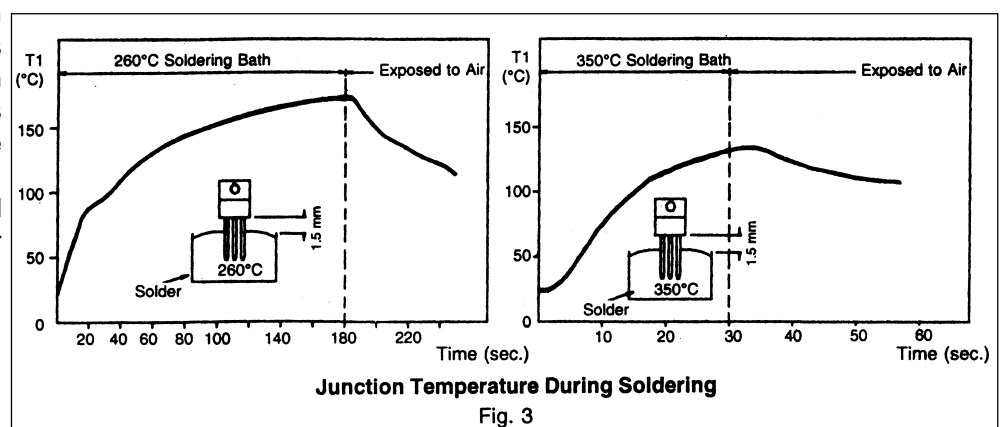

4. Mounting on Heat sink

To exploit best the performance of power transistor a heat sink with R_{th} suitable for the power that the transistor will dissipate must be used.

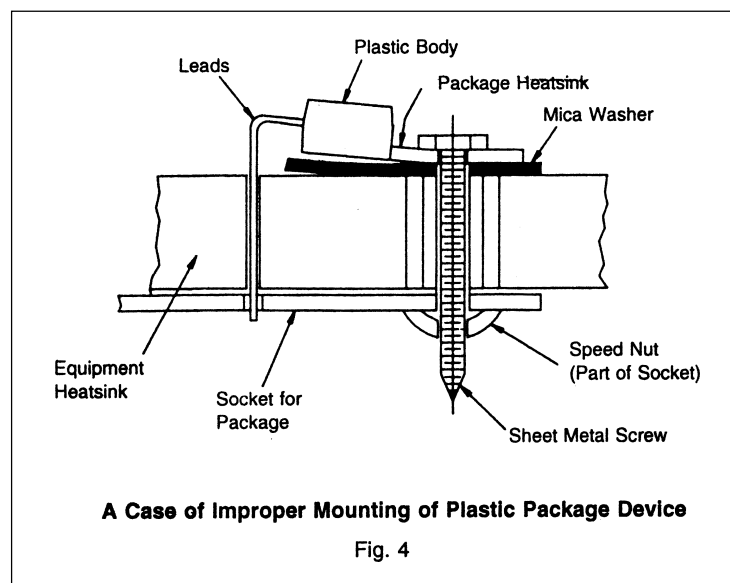

Disclaimer

The product information and the selection guides facilitate selection of the CDIL's Semiconductor Device(s) best suited for application in your product(s) as per your requirement. It is recommended that you completely review our Data Sheet(s) so as to confirm that the Device(s) meet functionality parameters for your application. The information furnished in the Data Sheet and on the CDIL Web Site/CD are believed to be accurate and reliable. CDIL however, does not assume responsibility for inaccuracies or incomplete information. Furthermore, CDIL does not assume liability whatsoever, arising out of the application or use of any CDIL product; neither does it convey any license under its patent rights nor rights of others. These products are not designed for use in life saving/support appliances or systems. CDIL customers selling these products (either as individual Discrete Semiconductor Devices or incorporated in their end products), in any life saving/support appliances or systems or applications do so at their own risk and CDIL will not be responsible for any damages resulting from such sale(s).

CDIL strives for continuous improvement and reserves the right to change the specifications of its products without prior notice.



CDIL is a registered Trademark of

Continental Device India Limited

C-120 Naraina Industrial Area, New Delhi 110 028, India.

Telephone + 91-11-2579 6150, 4141 1112 Fax + 91-11-2579 5290, 4141 1119

email@cdil.com www.cdilsemi.com