

BTB24

Rev.A May.-2016

描述 / Descriptions

TO-220 塑封封装 双向可控硅。 Triac in a TO-220 Plastic Package.

特征 / Features

大电流可控硅，低通态压降，高可靠性和稳定性，热敏电阻特性低。

High current triac, Low on state voltage drop, High reliability and stability, Low thermal resistance.

用途 / Applications

用于开关交流转换。如固态继电器、调光器和家电电机速度控制器等。

For power AC switching operations. Such as static relays, light dimmers and appliance motors speed controllers, etc.

内部等效电路 / Equivalent Circuit



引脚排列 / Pinning

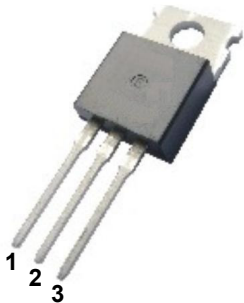

PIN1 : Main Terminal 1 PIN 2 : Main Terminal 2 PIN 3: Gate

放大及印章代码 / h_{FE} Classifications & Marking

见印章说明。 See Marking Instructions.

极限参数 / Absolute Maximum Ratings(Ta=25°C)

参数 Parameter	符号 Symbol	数值 Rating	单位 Unit
Repetitive peak off-state voltages	V_{DRM}/V_{RRM}	600/800	V
RMS on-state current(full sine wave $T_C=75^\circ\text{C}$)	$I_{T(RMS)}$	25	A
Non repetitive surge peak on-state current(full cycle, T_j initial = 25°C)	$I_{TSM}(F=50\text{Hz}$ $t=20\text{ms})$	250	A
Non repetitive surge peak on-state current(full cycle, T_j initial = 25°C)	$I_{TSM}(F=60\text{Hz}$ $t=16.7\text{ms})$	260	A
I^2t value for fusing	$I^2t_{(tp=10\text{ms})}$	340	A^2s
Critical rate of rise of on-state current $I_G = 2 \times I_{GT}$, $t_r \leq 100 \text{ ns}$ ($F=120\text{Hz}$ $T_j=125^\circ\text{C}$)	di/dt	50	$\text{A}/\mu\text{s}$
Non repetitive surge peak off-state Voltage($t_p = 10 \text{ ms}$ $T_j = 25^\circ\text{C}$)	V_{DSM}/V_{RSM}	V_{DRM}/V_{RRM} + 100	V
Peak gate current($t_p = 20\mu\text{s}$ $T_j=125^\circ\text{C}$)	I_{GM}	4.0	A
Average gate power dissipation($T_j=125^\circ\text{C}$)	$P_{G(AV)}$	1.0	W
Operating junction temperature range	T_j	-40 ~ 125	$^\circ\text{C}$
Storage junction temperature range	T_{stg}	-40 ~ 150	$^\circ\text{C}$
Junction to ambient	$R_{th(j-a)}$	60	$^\circ\text{C}/\text{W}$
Junction to case (AC)	$R_{th(j-c)}$	1.7	$^\circ\text{C}/\text{W}$

电性能参数 / Electrical Characteristics(Ta=25°C)
免缓冲器和逻辑电平 (3 象限) / Snubberless and logic level (3 quadrants)

符号 Symbol	测试条件 Test Conditions	信号区 Quadrant	BTB24		单位 Unit	
			CW	BW		
$I_{GT}^{(1)}$	$V_D=12\text{V}$ $R_L=33\Omega$	I-II-III	Max.	35	50	mA
V_{GT}	$V_D=12\text{V}$ $R_L=33\Omega$	I-II-III	Max.	1.3		V
V_{GD}	$V_D=V_{DRM}$ $R_L=3.3\text{K}\Omega$ $T_j=125^\circ\text{C}$	I-II-III	Min.	0.2		V
$I_H^{(2)}$	$I_T=500\text{mA}$		Max.	50	75	mA
I_L	$I_G=1.2I_{GT}$	I-III	Max.	70	80	mA
		II		80	100	
$dV/dt^{(2)}$	$V_D = 67\% V_{DRM}$ gate open $T_j = 125^\circ\text{C}$		Min.	500	1000	$\text{V}/\mu\text{s}$
$(di/dt)_c^{(2)}$	Without snubber $T_j = 125^\circ\text{C}$		Min.	13	22	A/ms

Note 1: minimum I_{GT} is guaranteed at 5% of I_{GT} max.

Note 2: for both polarities of A2 referenced to A1.

电性能参数 / Electrical Characteristics(Ta=25°C)

标准 (4象限) / Standard (4 quadrants)

符号 Symbol	测试条件 Test Conditions	信号区 Quadrant		BTB24		单位 Unit
					B	
$I_{GT}^{(1)}$	$V_D=12V$ $R_L=33\Omega$	I-II-III IV	Max.	50 100		mA
V_{GT}	$V_D=12V$ $R_L=33\Omega$	ALL	Max.	1.3		V
V_{GD}	$V_D=V_{DRM}$ $R_L=3.3K\Omega$ $T_j=125^\circ C$	ALL	Min.	0.2		V
$I_H^{(2)}$	$I_T=500mA$		Max.	80		mA
I_L	$I_G=1.2I_{GT}$	I-III- IV	Max.	70		mA
		II		160		
$(dV/dt)^{(2)}$	$V_D=67\%$ V_{DRM} gate open $T_j=125^\circ C$		Min.	500		V/ μs
$(dV/dt)^{(2)}_c$	$(dI/dt)^{(2)}_c=13.3A/ms$ $T_j=125^\circ C$		Min.	10		

Note 1: minimum I_{GT} is guaranteed at 5% of I_{GT} max.

Note 2: for both polarities of A2 referenced to A1.

电性能参数 / Electrical Characteristics(Ta=25°C)

符号 Symbol	测试条件 Test Conditions			数值 Value	单位 Unit
$V_{TM}^{(1)}$	$I_{TM}=35A$	$t_p=380\mu s$ $T_j=25^\circ C$	Max.	1.55	V
$V_{to}^{(1)}$	Threshold voltage $T_j=125^\circ C$		Max.	0.85	V
$R_d^{(1)}$	Dynamic resistance $T_j=125^\circ C$		Max.	16	m Ω
I_{DRM} I_{RRM}	$V_{DRM} = V_{RRM}$	$T_j=25^\circ C$	Max.	5.0	μA
		$T_j=125^\circ C$	Max.	3.0	mA

Note1. for both polarities of A2 referenced to A1

电参数曲线图 / Electrical Characteristic Curve

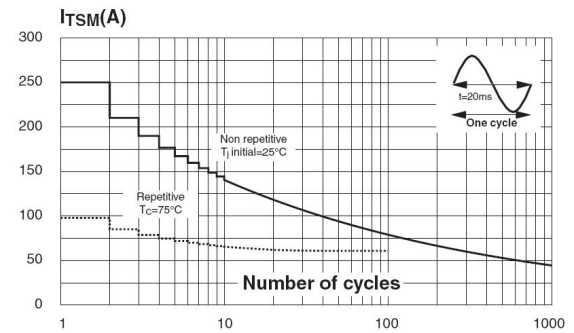
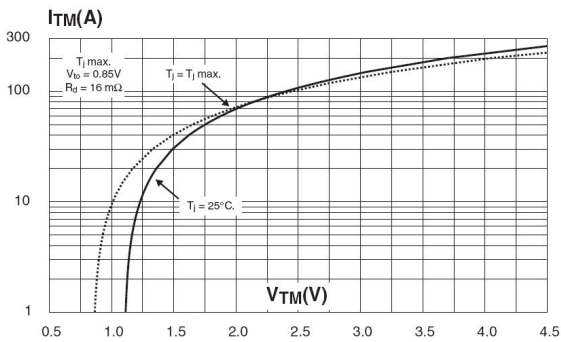
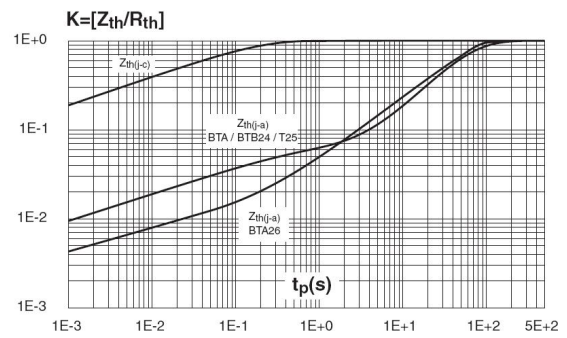
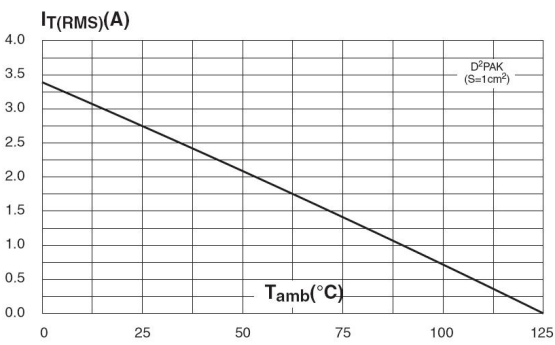
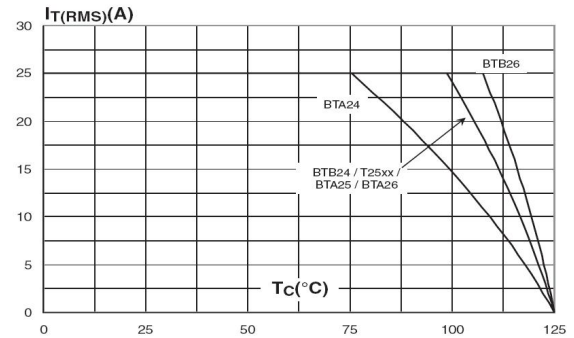
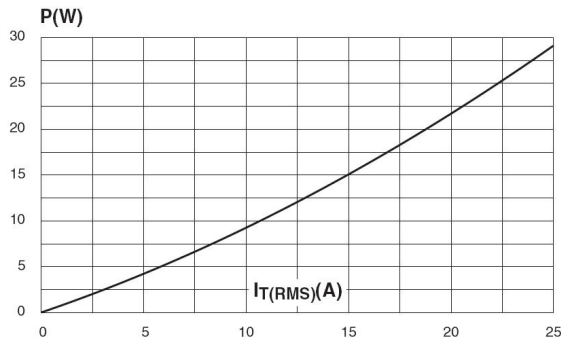

电参数曲线图 / Electrical Characteristic Curve

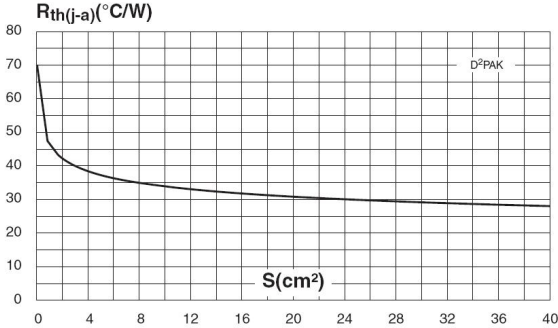
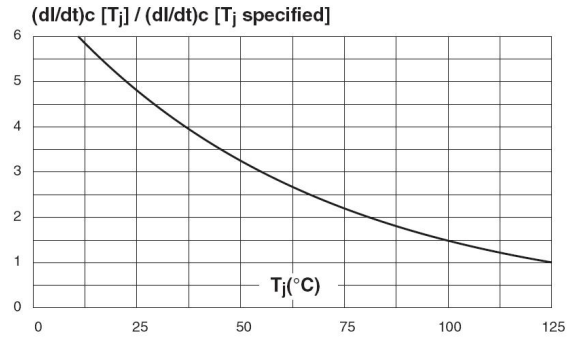
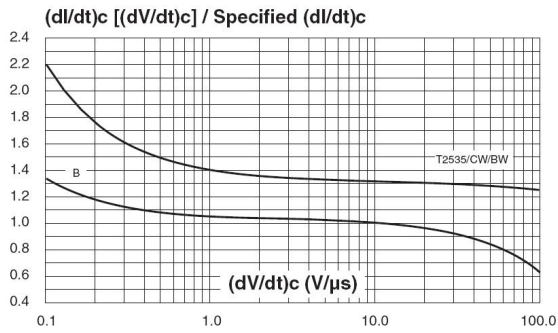
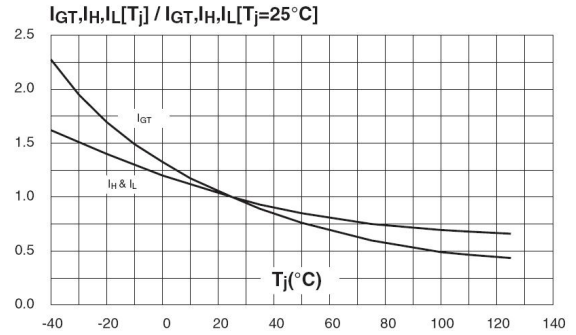
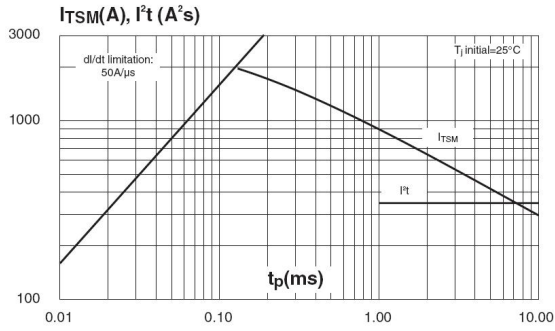

外形尺寸图 / Package Dimensions

TO-220

单位: mm

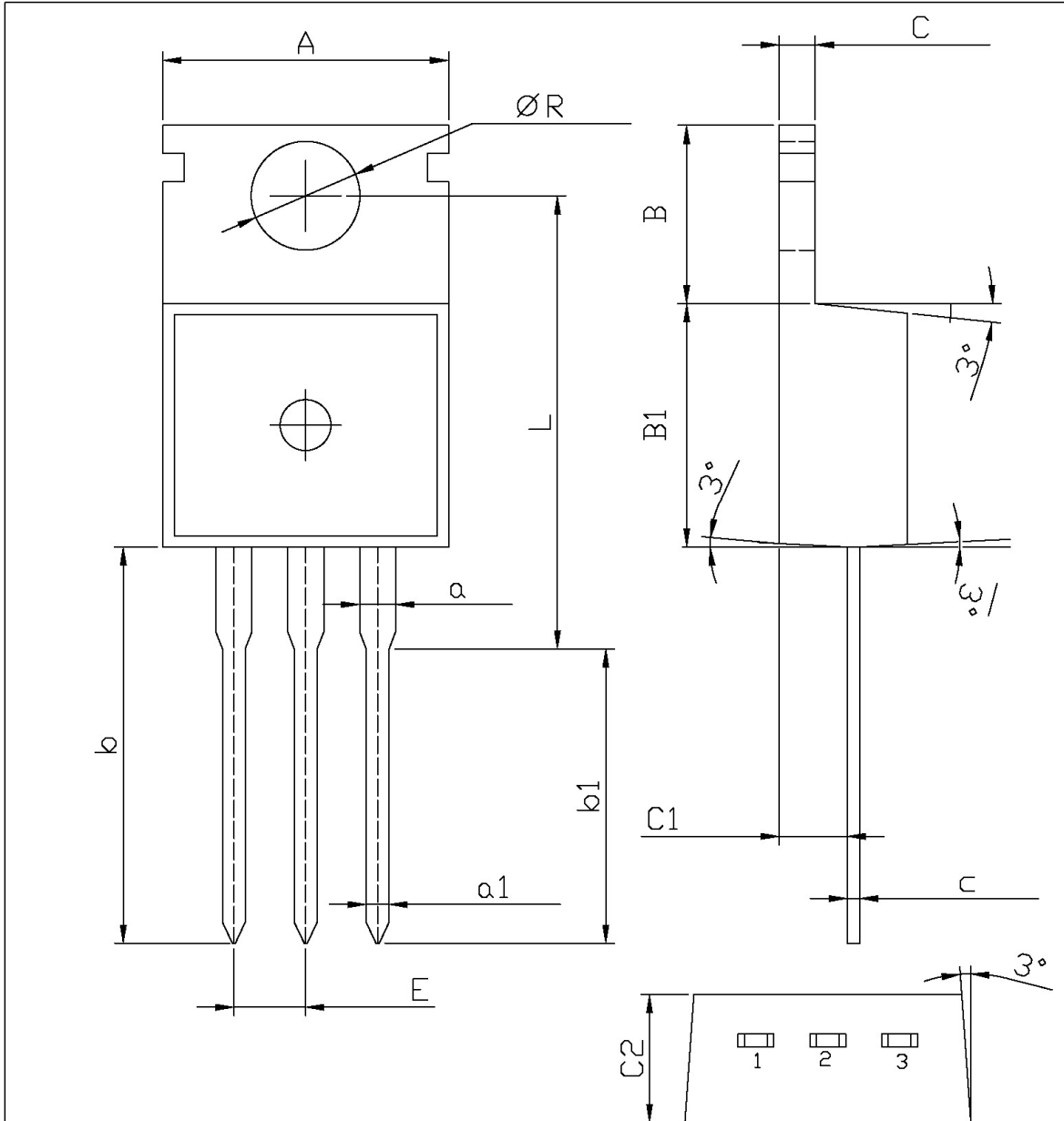

Symbol	Dimensions In Millimeters		Symbol	Dimensions In Millimeters	
	Min	Max		Min	Max
A	9.8	10.2	C	1.2	1.4
R	3.56	3.64	B	6.3	6.7
L	15.7	16.1	B1	9.0	9.4
b	12.6	13.6	C1	2.2	2.6
b1	9.6	10.6	a1	0.7	0.9
a	1.22	1.32	c	0.4	0.6
E	2.34	2.74	C2	4.3	4.7

印章说明 / Marking Instructions

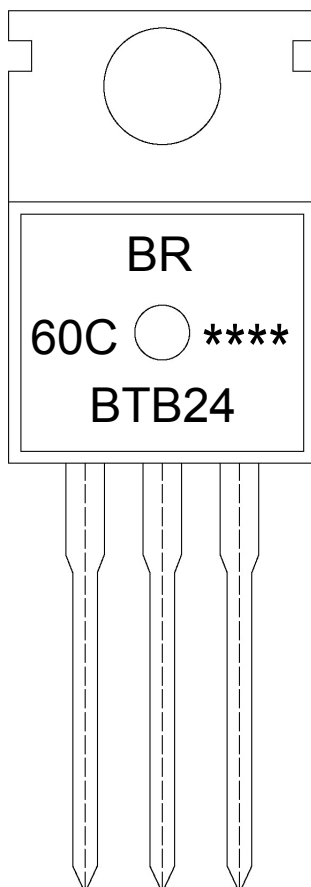

说明：

BR： 为公司代码

60C： 为 V_{RRM} 和 I_{GT} 分档代码

BTB24： 为产品型号

****： 为生产批号代码，随生产批号变化。

Note:

BR: Company Code

60C: V_{RRM}/I_{GT} Bracket code

BTB24: Product Type.

****: Lot No. Code, code change with Lot No.

波峰焊温度曲线图(无铅) / Temperature Profile for Dip Soldering(Pb-Free)

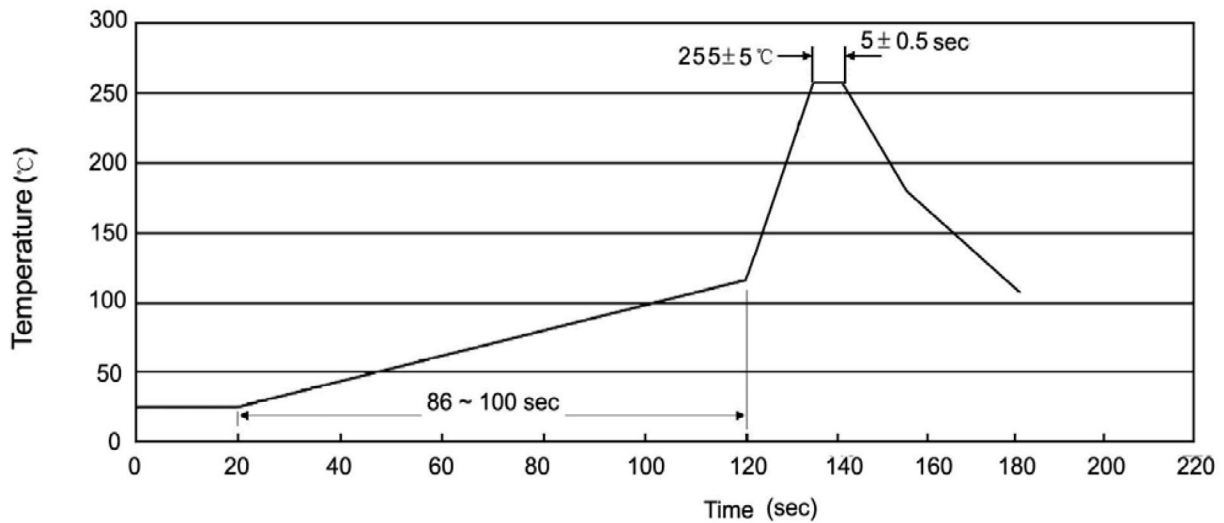

说明：

- 1、预热温度 25 ~ 150°C，时间 60 ~ 90sec;
- 2、峰值温度 255±5°C，时间持续为 5±0.5sec;
- 3、焊接制程冷却速度为 2 ~ 10°C/sec.

Note:

- 1.Preheating:25~150°C, Time:60~90sec.
- 2.Peak Temp.:255±5°C, Duration:5±0.5sec.
3. Cooling Speed: 2~10°C/sec.

耐焊接热试验条件 / Resistance to Soldering Heat Test Conditions

温度：270±5°C

时间：10±1 sec.

Temp.:270±5°C

Time:10±1 sec

包装规格 / Packaging SPEC.

散件包装 / BULK

Package Type 封装形式	Units 包装数量					Dimension 包装尺寸 (unit: mm ³)		
	Units/Bag 只/袋	Bags/Inner Box 袋/盒	Units/Inner Box 只/盒	Inner Boxes/Outer Box 盒/箱	Units/Outer Box 只/箱	Bag 袋	Inner Box 盒	Outer Box 箱
TO-220/F	200	10	2,000	5	10,000	135×190	237×172×102	560×245×195

套管包装 / TUBE

Package Type 封装形式	Units 包装数量					Dimension 包装尺寸 (unit: mm ³)		
	Units/Tube 只/套管	Tubes/Inner Box 套管/盒	Units/Inner Box 只/盒	Inner Boxes/Outer Box 盒/箱	Units/Outer Box 只/箱	Tube 套管	Inner Box 盒	Outer Box 箱
TO-220/F	50	20	1,000	5	5,000	532×31.4×5.5	555×164×50	575×290×180

使用说明 / Notices